

DATA SHEET

SA2411

+20 dBm single chip linear amplifier for WLAN

Product data

2003 Feb 07

Supersedes data of 2002 Jul 31

+20 dBm single chip linear amplifier for WLAN**SA2411****1. DESCRIPTION**

The SA2411 is a linear power amplifier designed for WLAN application in the 2.4 GHz band. Together with the SA2400A the chips form a complete 802.11b transceiver. The SA2411 is a Si power amplifier with integrated matching and power level detector.

2. FEATURES

- 75 Ω + 25j Ω differential inputs, internally matched
- 50 Ω single-ended output, internally matched
- 15 dB gain block
- Power detector
- Bias adjust pin
- 18% efficiency at 3 V
- RF matching for SA2400A

3. APPLICATIONS

- IEEE 802.11 and 802.11b radios
- Supports DSSS and CCK modulation
- Supports data rates: 1, 2, 5.5, and 11 Mbps
- 2.45 GHz ISM band wireless communication devices

Table 1. Ordering information

TYPE NUMBER	PACKAGE		VERSION
	NAME	DESCRIPTION	
SA2411DH	TSSOP16	plastic thin shrink small outline package; 16 leads; body width 4.4 mm	SOT403-1

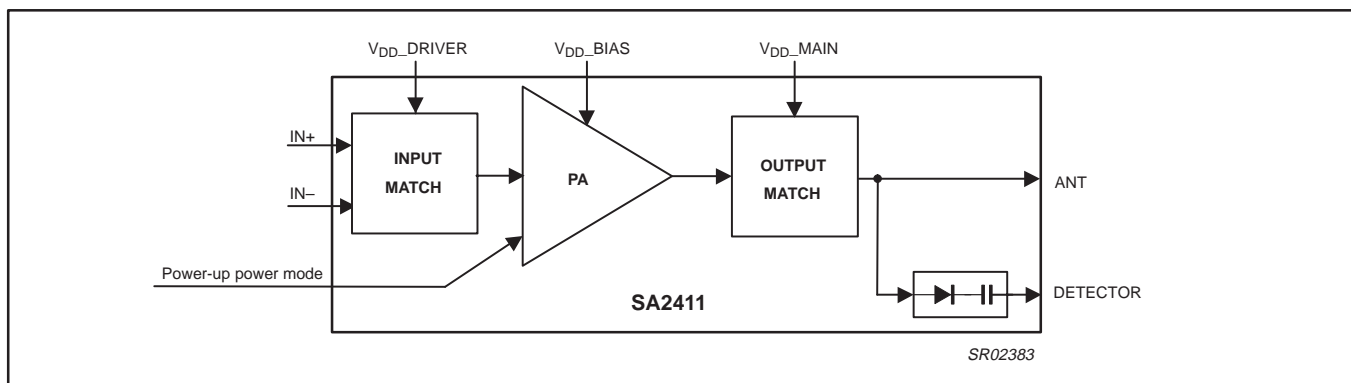
4. BLOCK DIAGRAM**Figure 1. Block diagram**

+20 dBm single chip linear amplifier for WLAN

SA2411

5. PINNING INFORMATION

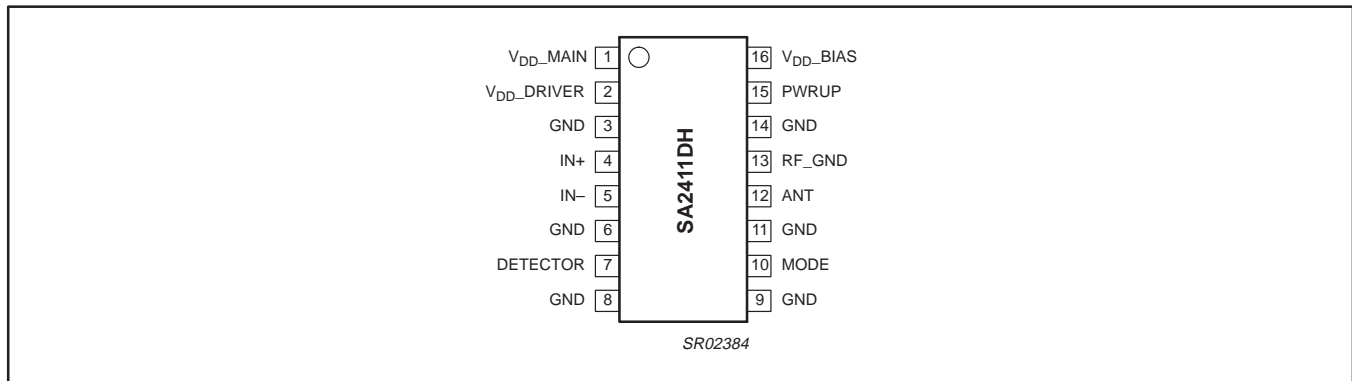

Figure 2. Pin configuration

Table 2. Pin description

PIN type is designated by A = Analog, D = Digital, I = Input, O = Output

SYMBOL	PIN	DESCRIPTION	TYPE
V _{DD_MAIN}	1	Analog supply, V _{DD} for power amplifier, 150 mA	A
V _{DD_DRIVER}	2	Analog supply, V _{DD} for biasing driver, 35 mA	A
GND	3	Grounding	A
IN+	4	Input pin, positive part of balanced signal	AI
IN-	5	Input pin, negative part of balanced signal	AI
GND	6	Grounding	A
DETECTOR	7	Power detector output	AO
GND	8	Grounding	A
GND	9	Grounding	A
MODE	10	Mode switch; floating = high gain, grounded = low gain	AI
GND	11	Grounding	A
ANT	12	Output pin, RF, to antenna	AO
RF_GND	13	RF ground must be connected	A
GND	14	Grounding	A
PWRUP	15	Power up pin. HIGH = amplifier is on. LOW = amplifier is off.	DI
V _{DD_BIAS}	16	Analog supply, V _{DD} for biasing the amplifier, 5 mA	A

All GND pins should be connected to ground to guarantee the best performance.

+20 dBm single chip linear amplifier for WLAN

SA2411

6. FUNCTIONAL DESCRIPTION

The main building-blocks are:

- Fixed gain amplifier (PA)
- Output matching
- Input matching
- Power Detector
- Power Mode

Input

The device has differential inputs so a balun is needed in the case of single ended operation, input impedance is approximately $75 \Omega + 25j \Omega$, balanced. The inputs can be DC biased with the pin V_{DD_DRIVER} . The input matching is optimized to interface with the SA2400A WLAN transceiver chip.

Amplifier

The amplifier is a fixed gain, class AB amplifier. There is an additional pin, V_{DD_BIAS} , to adjust the class A bias current. Reducing the class A currents reduces the gain. This allows trade-offs to be made among gain, linearity and current.

Output matching

The output of the amplifier is matched, on chip, for a 50Ω load. The matching includes the supply feed for the power amplifier. The pin V_{DD_MAIN} is the main supply for the amplifier. No additional filtering is needed to meet the 802.11b spec.

Power detector

The power detector detects the power level and transforms it into a low frequency current. The detector output must be loaded with a resistor to ground for the highest accuracy. This resistor has an optimal value of $5.6 \text{ k}\Omega$. Lower values can be used to comply with maximum input sensitivity of ADCs, at the cost of dynamic range. The maximum voltage detected is 2.3 V.

Power mode

This pin selects the desired gain and linearity level (13 dB or 14.5 dB gain). The low gain is more applicable to high voltage applications from 3.3 V to 3.6 V. The high gain is more applicable to low voltage applications lower than 3.3 V.

NOTE:

In order to assure optimal thermal performance, it is recommended that all ground pins be connected, and that the number of vias to ground under the chip be maximized. In addition, the use of solder mask under the chip (for scratch protection) is not recommended.

+20 dBm single chip linear amplifier for WLAN

SA2411

7. CONNECTIVITY DIAGRAM

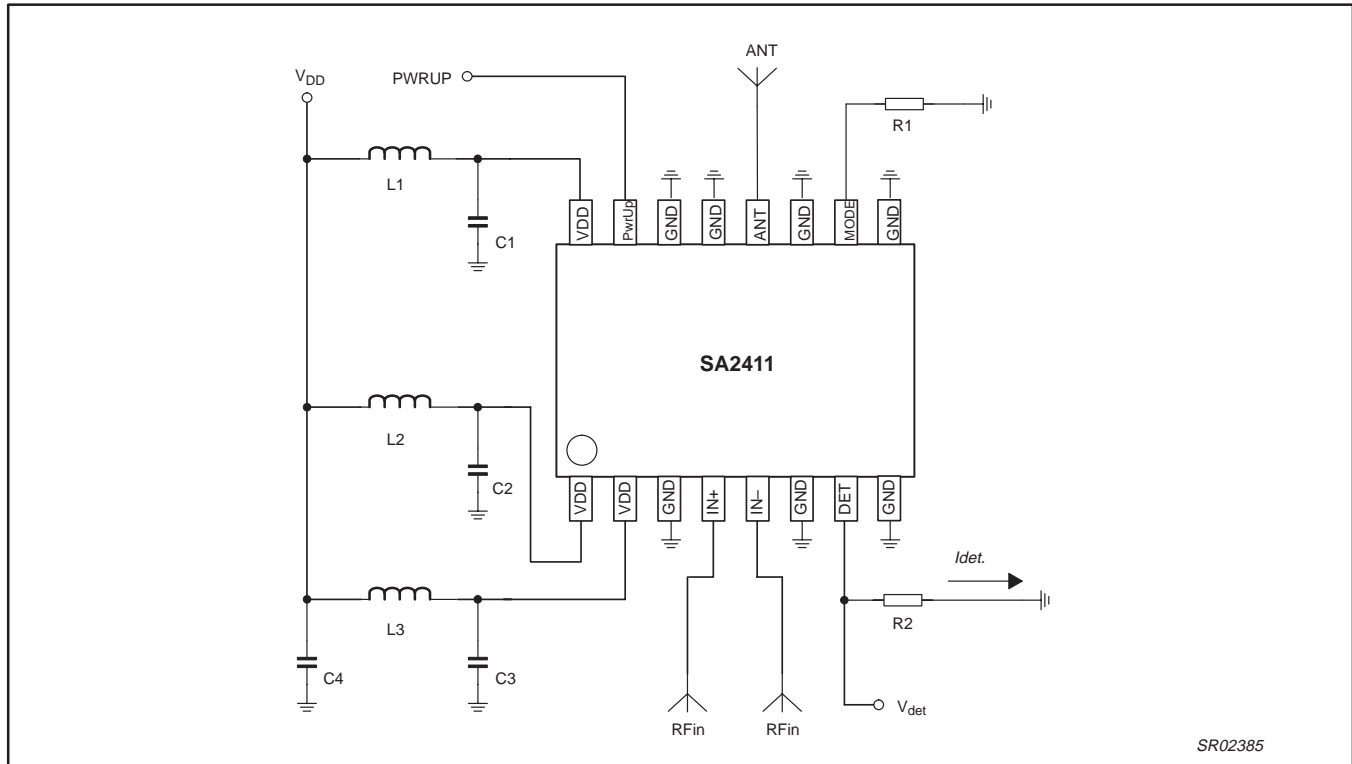

SR02385

C1, C2, C3 = 5.6 pF

C4 = 10 nF

R1 = optional connect to ground via 0 Ω resistor.

R2 = optional resistor to ground to convert current into voltage

L1, L2, L3 = Optional inductors
1 nH ... 10 nH, or microstrip lines with length 1 ... 10 mm.

No inductors and directly connecting all supplies to V_{DD} might cause problems. The optimal values of the inductors depends on the application board.

+20 dBm single chip linear amplifier for WLAN**SA2411****8. OPERATION**

The SA2411 linear amplifier is intended for operation in the 2.4 GHz band, specifically for IEEE 802.11 1 and 2 Mbps/s DSSS, and 5.5 and 11 Msymbols/s CCK standards. Throughout this document, the operating RF frequency refers to the ISM band between 2.4 and 2.5 GHz.

Amplifier Output Power

The SA2411 linear amplifier is designed to give at least 19 dBm output power for an 11 Msymbols/s CCK modulated input carrier. At 19 dBm output power the ACPR specs are met. The fixed gain amplifier amplifies the input signal by 14.5 dB typically.

Power Mode

The biasing can be adjusted to change the gain and therefore the maximum linear output power. For high supply voltages (>3.2 V) the low-gain mode is advised. For low supply voltages (<3.3 V) the high-gain mode is advised.

Power Mode	Pin 9 =	Typical output power	Typical small signal Gain	Typical DC current (no RF signal)	Typical Current consumption
High	Floating	20.0 dBm	14.5 dB	35 mA	185 mA @ 20 dBm
Low	Grounded	20.0 dBm	13 dB	28 mA	185 mA @ 20 dBm

Power detector

The power detector current output is linear proportional with the RF output voltage. The RF output power is quadratic proportional to the RF output voltage. Therefore, the detector is quadratic proportional to the output power. The following relation can be expressed:

$$P_{out} = k \times V_{detector}^n$$

P_{out} is output power in mWatt, $V_{detector}$ is detector voltage in Volt, k = sensitivity in mWatt/V², n = quadratic factor.

The quadratic factor is 1.5. The sensitivity is then 49 mWatt/V².

P_{out}	$V_{detector}$ (5.6 k Ω load)	$I_{detector}$ (5.6 k Ω in series)
20 dBm = 100 mW	1.7 V	300 μ A
19 dBm = 79 mW	1.4 V	250 μ A
17 dBm = 50 mW	1.0 V	175 μ A
15 dBm = 32 mW	0.7 V	125 μ A
9 dBm = 8 mW	0.3 V	50 μ A

The loading of the detector can be different in the application. The highest accuracy is achieved with 5.6 k Ω . But other values can be used to adapt to the maximum input sensitivity of other circuits. Other detector loading values result in other k-factors. The maximum detector voltage is limited to about 2.4 V.

DC feed at input

There is a possibility to add a DC voltage at the input pins (pin 4 and pin 5) by feeding pin 2. This option should be used in case the SA2411 is lined up with the SA2400A.

+20 dBm single chip linear amplifier for WLAN**SA2411****9. OPERATING CONDITIONS**

The SA2411 shall meet all of the operating conditions outlined in this section. Table 3 specifies the absolute maximum ratings for the device. Table 4 gives the recommended operating conditions.

Table 3. Absolute maximum ratings

Symbol	Parameter	Min	Max	Unit
T _{stg}	Storage temperature	-55	+150	°C
V _{DDa}	Supply voltage (analog)	-0.5	+3.85	V
-	Voltage applied to inputs	-0.5	V _{DD} +0.5	V
-	Short circuit duration, to GND or V _{DD}	-	1	sec

Table 4. Recommended operating conditions

Symbol	Parameter	Min	Nom	Max	Units
T _{amb}	Ambient operating temperature	-40	-	+85	°C
V _{DDa}	Supply voltage (analog)	2.85	3.3	3.6	V

10. SA2411 TRANSMITTER REQUIREMENTS**Table 5. SA2411 transmitter specifications**

T_{amb} = 25 °C; V_{CC} = 3 V; frequency = 2.45 GHz, R_{detector} = 5.6 kΩ, unless otherwise stated.

Specification	Condition, Remarks	Min	Nom	Max	Units
DC					
DC current	Standard mode (pin 10 is floating)	-	35	-	mA
DC current	Low output power mode (pin 10 is grounded)	-	28	-	mA
Leakage current	V _{pwrap} = 0 V. V _{ss} = 3.0 V	-	-	10	μA
AC : 802.11b MODULATION					
Output back off	(relative to 1 dB compression of single carrier)	-	2	-	dB
RF frequency		2.4	2.45	2.5	GHz
Input impedance	Differential (75 Ω + 25j Ω)	-	100	-	Ω
Load impedance	Single ended	-	50	-	Ω
Power gain for small signal	Mode = High gain, Input level = -20 dBm	-	14.5	-	dB
Power gain for small signal	Mode = Low gain, Input level = -20 dBm	-	13	-	dB
Output power	Meeting the FCC specs of 30 dBc and 50 dBc, mode = high	-	+20.0	-	dBm
Current consumption	"	-	200	-	mA
Gain	"	-	12.5	-	dB
Output power	Meeting the FCC specs of 30 dBc and 50 dBc, mode = low	-	+20.0	-	dBm
Current consumption	"	-	200	-	mA
Gain	"	-	12.5	-	dB
Power ramping up time	10% to 90% ramp up	-	0.5	-	μs
Power ramping down (when enabled)	a) 90% to 10% ramp down b) 10% to carrier leakage level	-	0.5 0.5	-	μs
Error Vector Magnitude	11 Msymbols/s QPSK. Both RF outputs.	-	5	-	%
Isolation	Pin 15 (PWRUP) = 0 V	-	15	-	dB
Harmonic Suppression at 2 and 3 times fundamental frequency	fundamental frequency output power = +20 dBm	-	40	-	dBc

+20 dBm single chip linear amplifier for WLAN

SA2411

Table 6. SA2411 Detector specification

T_{amb} = 25 °C, V_{CC} = 3.0 V

Specification	Condition, Remarks	Min	Nom	Max	Units
GENERAL					
Detector sensitivity	With 5 kΩ load resistor to ground	–	49	–	mW/V ²
Detector accuracy per sample	At 16 dBm –40 °C to +80 °C; from 2.7 V to 3.6 V	–	0.3	–	dB
Absolute accuracy	From sample to sample	–	0.5	–	dB
Detector quadratic factor		–	1.5	–	–
Detector settling time	From 10% to 90% of final value	–	500	–	ns
Spread from sample to sample	20 dBm output power	–	1	–	dB
Absolute detector voltage	19 dBm output power	–	1.4	–	V
Absolute detector voltage error	From –30 °C to +80 °C; from 2.7 V to 3.6 V at 19 dBm output power	–	0.15	–	V
Detector power range		+10	–	+21	dBm

11. GRAPHS

The following graphs are only for a typical sample measured on a SA2411 test board under nominal condition applying an 11Mb/s CCK 802.11b modulation. Corrections for input, output and supply losses have been applied. **The dotted lines represent the low gain mode. The solid lines are for the high gain mode.**

The first two graphs are small signal graphs. The gain and the DC currents are plotted versus supply voltage.

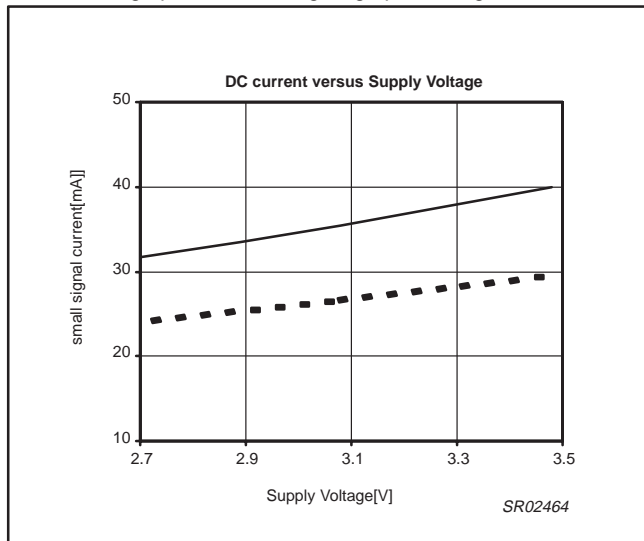

Figure 3. DC current vs. supply voltage

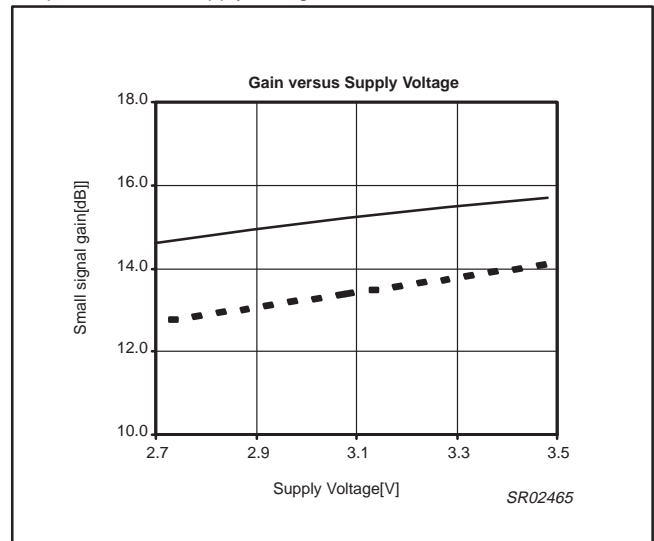

Figure 4. Gain vs. supply voltage

+20 dBm single chip linear amplifier for WLAN

SA2411

The next eight graphs are presenting the power sweep for both gain modes at nominal conditions.

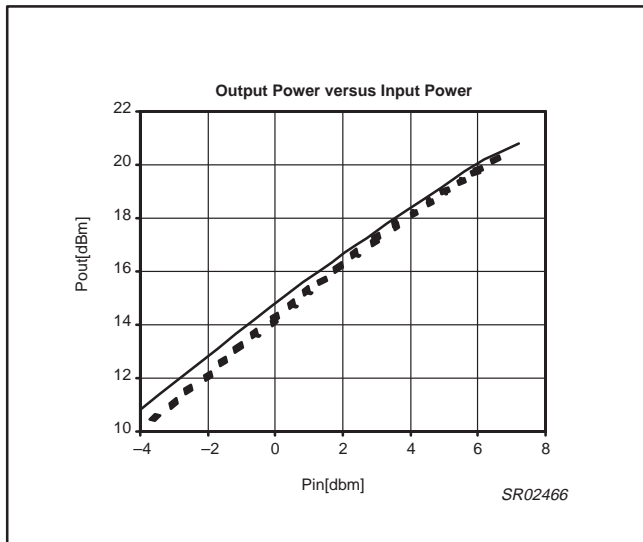

Figure 5. Output power vs. input power

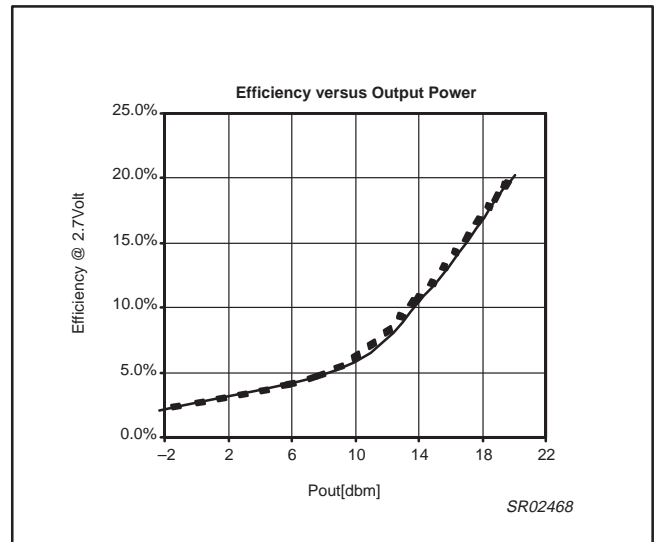

Figure 7. Efficiency vs. output power

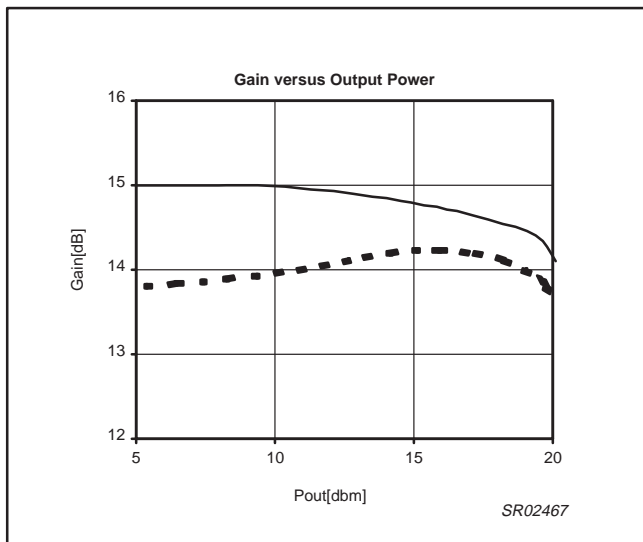

Figure 6. Gain vs. output power

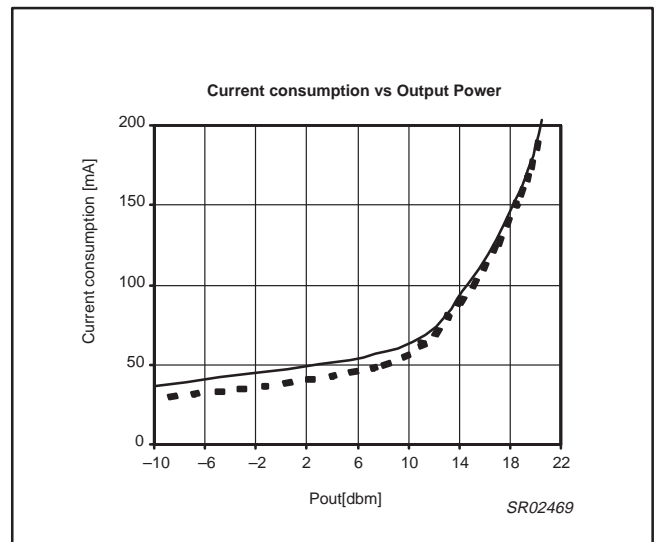

Figure 8. Current consumption vs. output power

+20 dBm single chip linear amplifier for WLAN

SA2411

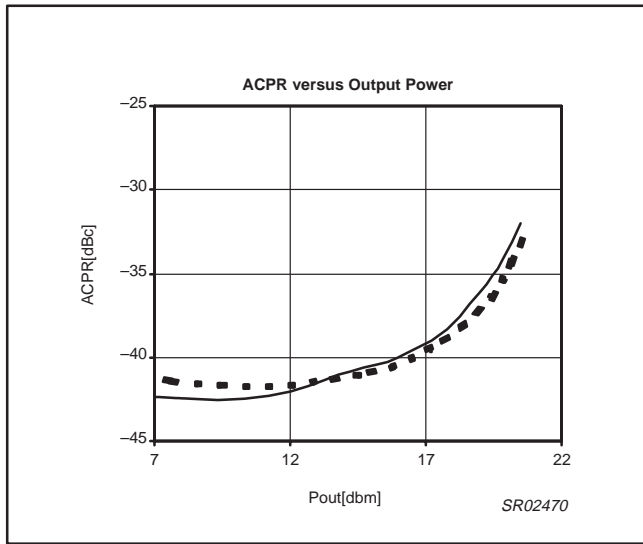

Figure 9. ACPR vs. output power

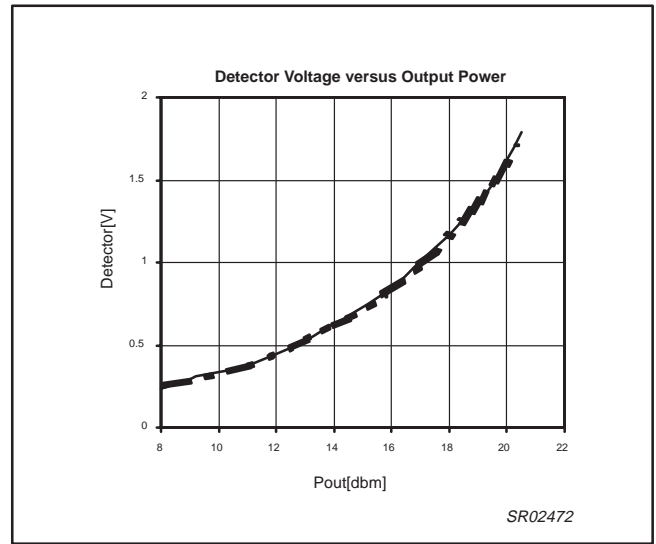

Figure 11. Detector voltage vs. output power

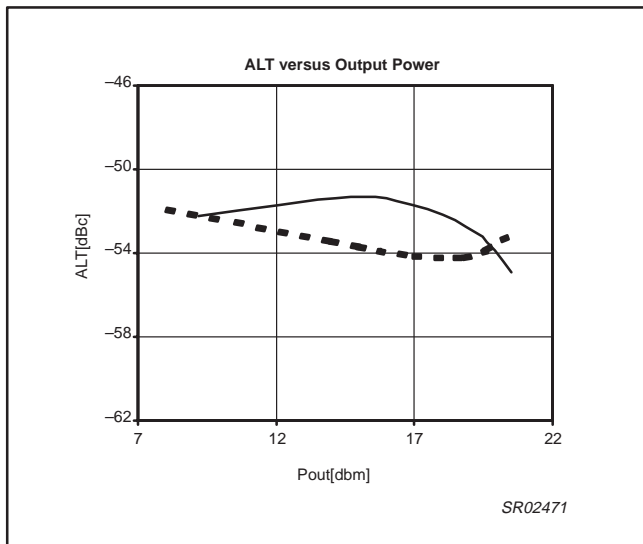

Figure 10. ALT vs. output power

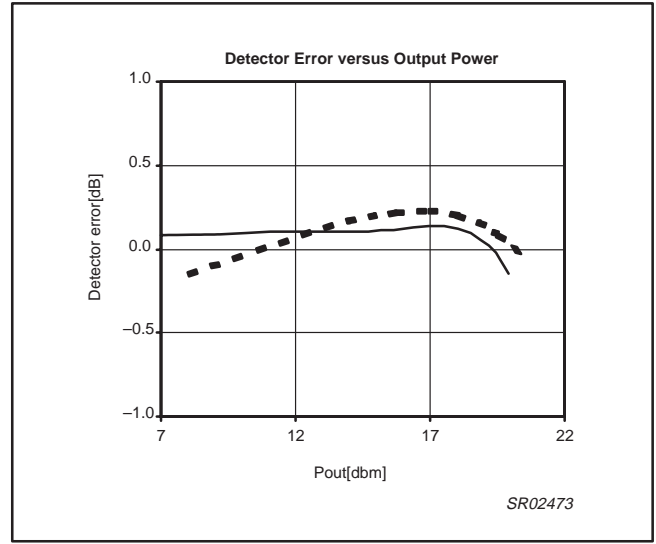

Figure 12. Detector error vs. output power

+20 dBm single chip linear amplifier for WLAN

SA2411

The next curves present the frequency dependency for an input power of +7 dBm:

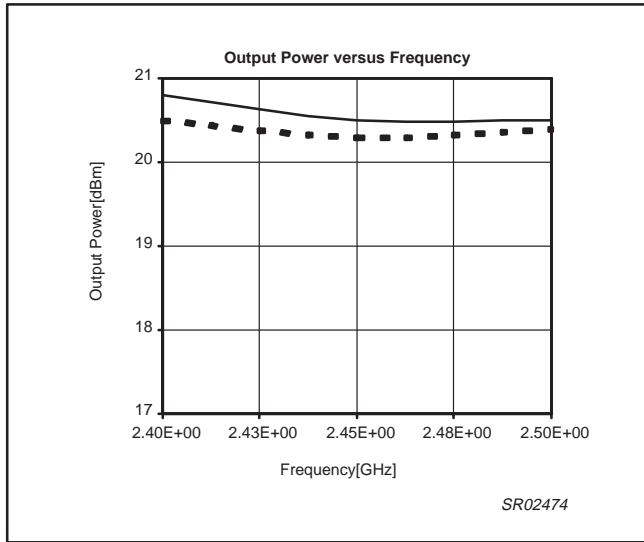

Figure 13. Output power vs. frequency

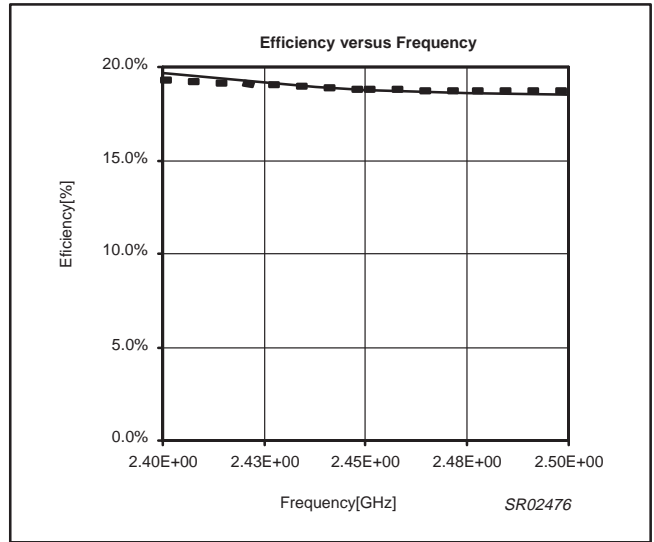

Figure 15. Efficiency vs. frequency

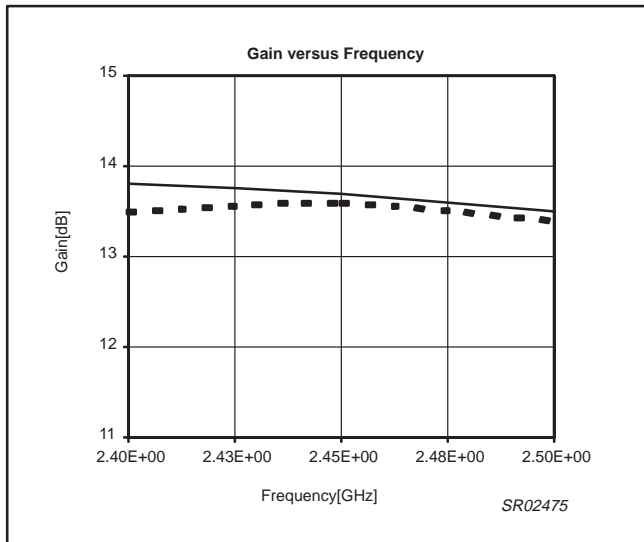

Figure 14. Gain vs. frequency

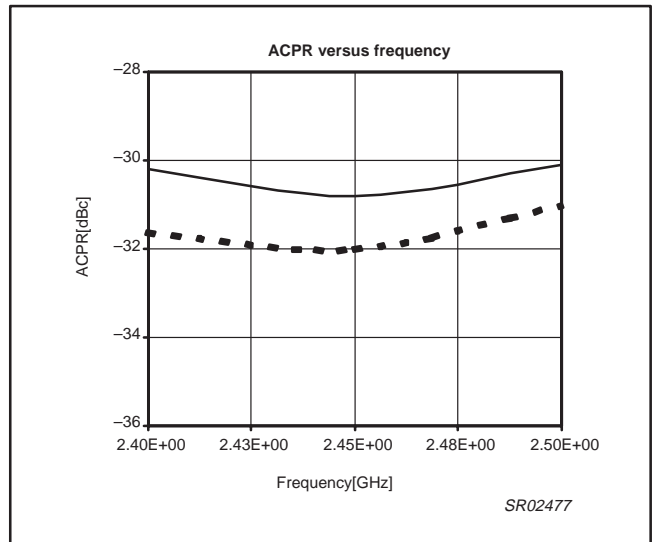

Figure 16. ACPR vs. frequency

+20 dBm single chip linear amplifier for WLAN

SA2411

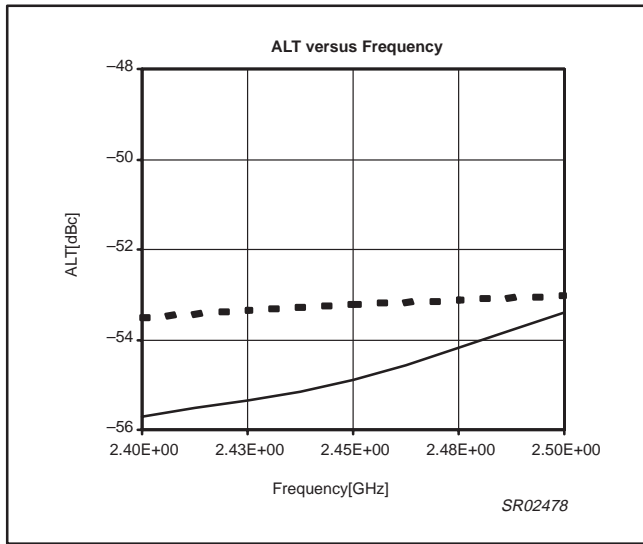

Figure 17. ALT vs. frequency

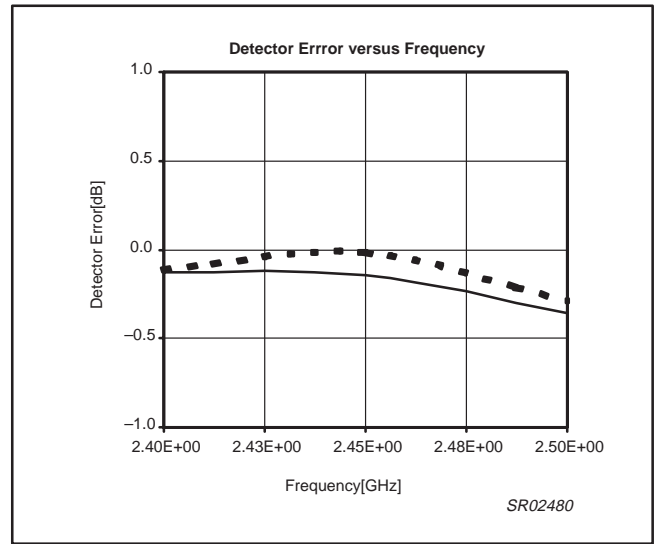

Figure 19. Detector error vs. frequency

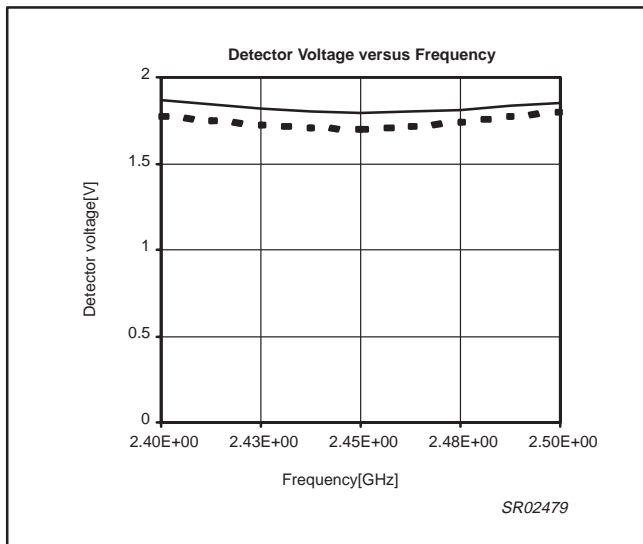

Figure 18. Detector voltage vs. frequency

+20 dBm single chip linear amplifier for WLAN

SA2411

The last 5 curves are characterization data for supply voltage, temperature and power. The worst-case scenario is the combination of highest temperature/lowest supply. The best-case scenario is the combination of lowest temperature and highest supply voltage. The data has been taken using a non-modulated carrier at 2.5 GHz.

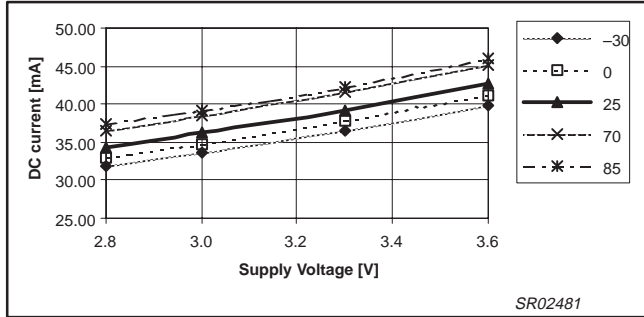

Figure 20. DC current vs. supply voltage, mode = high

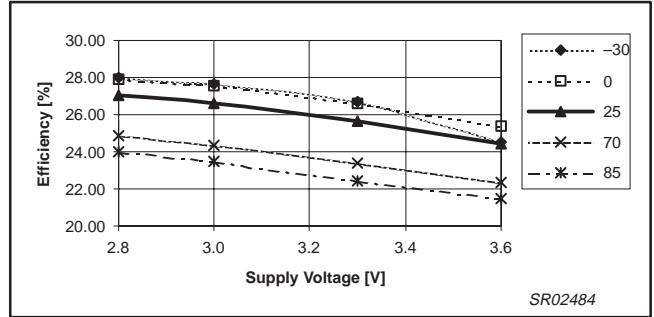

Figure 23. Efficiency vs. supply voltage, mode = high

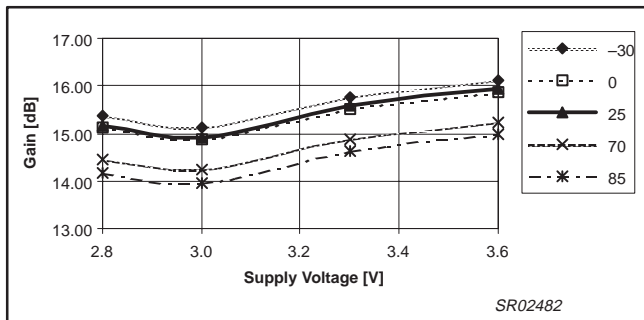

Figure 21. Gain vs. supply voltage, mode = high

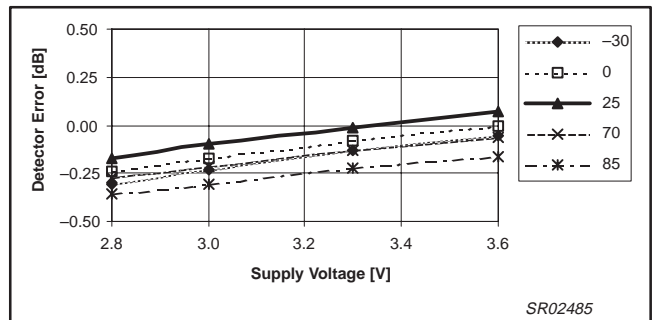

Figure 24. Detector error vs. supply voltage, mode = high

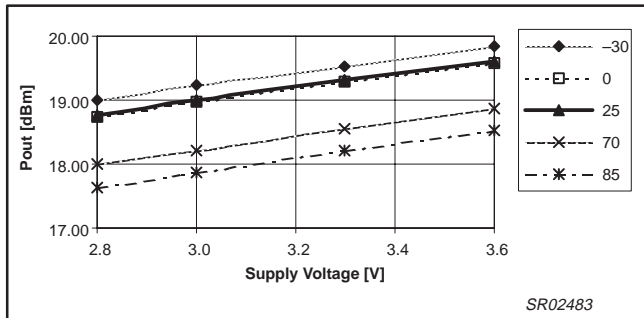

Figure 22. Output power vs. supply voltage, mode = high

+20 dBm single chip linear amplifier for WLAN

SA2411

12. APPLICATION WITH THE SA2400A

Next diagram is the application of the SA2400A with the SA2411.

The interface is simple. Two equal microstrip lines connect the SA2400A with the SA2411. The length of this connection should be kept to a minimum.

The supply for the open collectors of the SA2400A is provided via pin 2 of the SA2411.

C2 is for supply voltage decoupling.

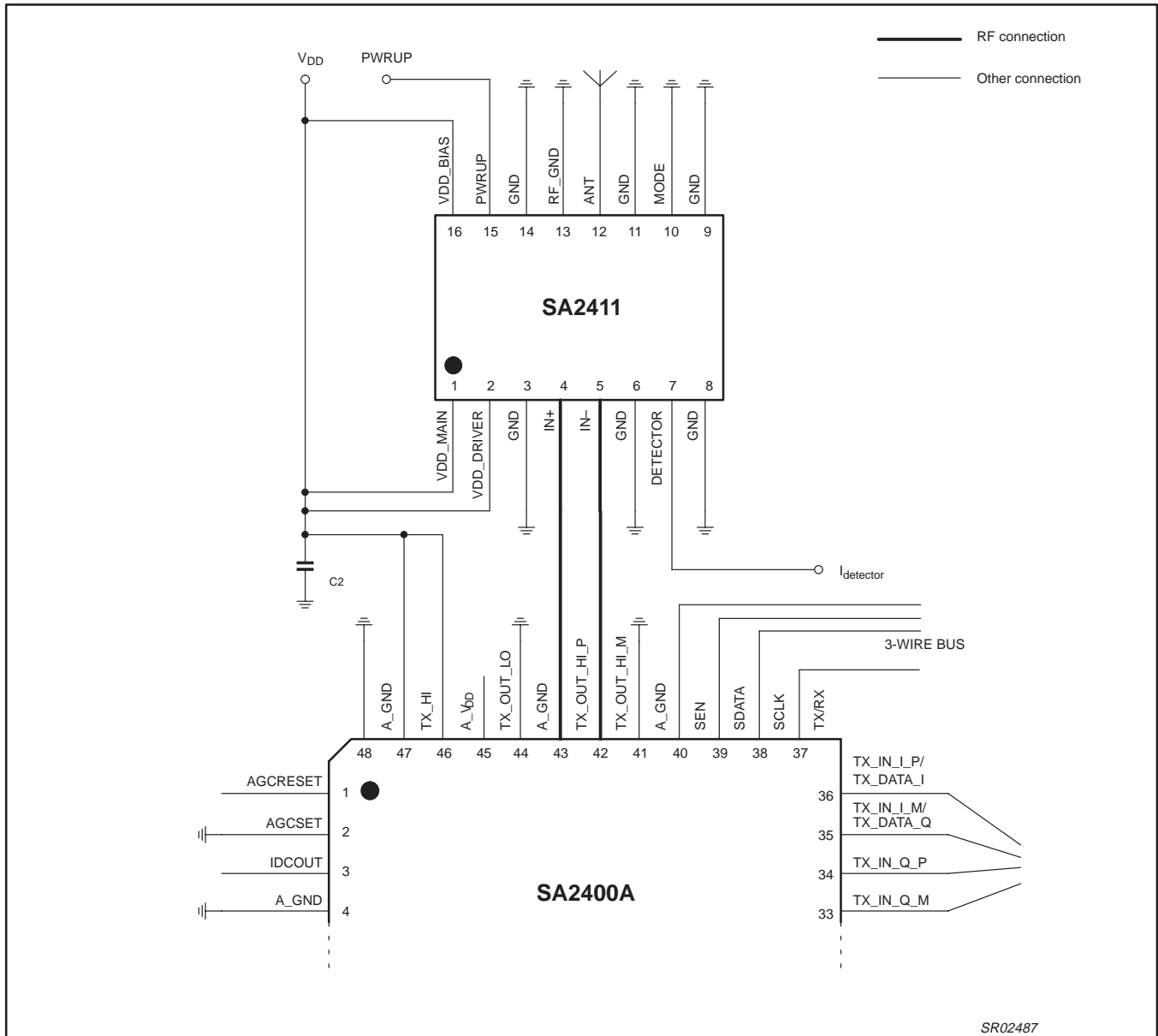

Figure 25.

NOTE: A suggested starting point for designing the coupled microstrip lines:
 Length = $1/18 \lambda$. Width = 12 mils, Separation = 5 mils with the Dielectric constant = 4.6.
 This should result in $Z_{\text{even}} = 150 \Omega$, $Z_o = 75 \Omega$, and $Z_{\text{odd}} = 30 \Omega$.
 There should be no ground plane under the microstrip lines.

+20 dBm single chip linear amplifier for WLAN

SA2411

TSSOP16: plastic thin shrink small outline package; 16 leads; body width 4.4 mm

SOT403-1

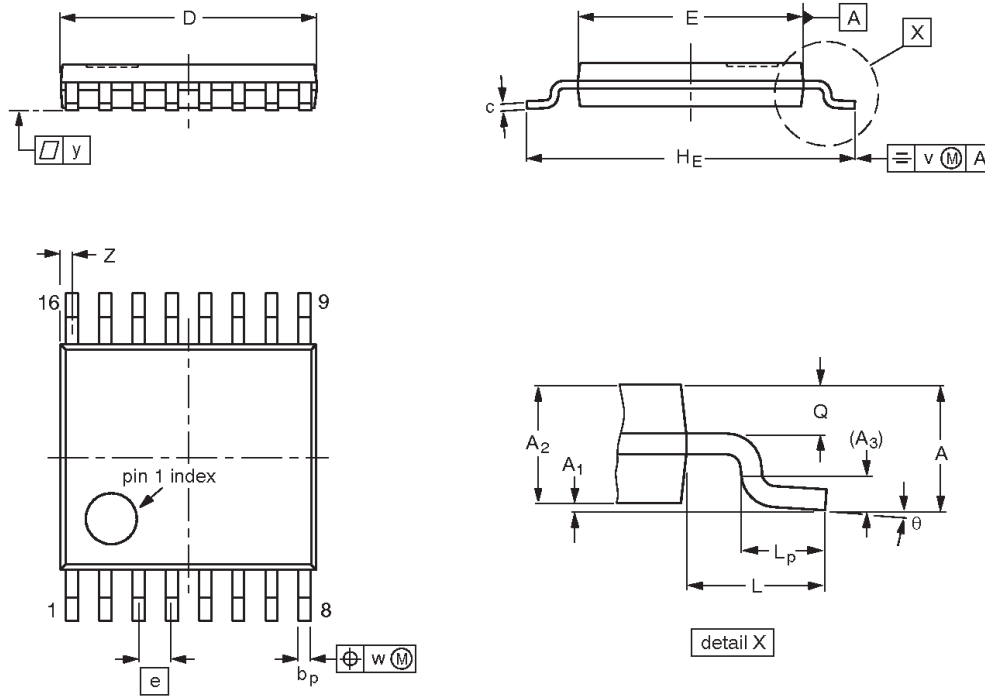

DIMENSIONS (mm are the original dimensions)

UNIT	A max.	A ₁	A ₂	A ₃	b _p	c	D ⁽¹⁾	E ⁽²⁾	e	H _E	L	L _p	Q	v	w	y	Z ⁽¹⁾	θ
mm	1.10	0.15 0.05	0.95 0.80	0.25	0.30 0.19	0.2 0.1	5.1 4.9	4.5 4.3	0.65	6.6 6.2	1.0	0.75 0.50	0.4 0.3	0.2	0.13	0.1	0.40 0.06	8° 0°

Notes

1. Plastic or metal protrusions of 0.15 mm maximum per side are not included.
2. Plastic interlead protrusions of 0.25 mm maximum per side are not included.

OUTLINE VERSION	REFERENCES				EUROPEAN PROJECTION	ISSUE DATE
	IEC	JEDEC	EIAJ			
SOT403-1		MO-153				95-04-04 99-12-27

+20 dBm single chip linear amplifier for WLAN**SA2411****REVISION HISTORY**

Rev	Date	Description
_3	20030207	<p>Product data (9397 750 10825); ECN 853-2346 29486 of 07 February 2003; supersedes Preliminary data SA2411 revision 2 of 31 July 2002 (9397 750 10166).</p> <p>Modifications:</p> <ul style="list-style-type: none"> ● Features (Section 2.) <ul style="list-style-type: none"> – First bullet: from “75 Ω” to “75 Ω + 25j Ω” – delete bullet “1 dB attenuator” ● Block diagram: signal “Power mode” changed to “Power-up power mode”. ● Pin names modified. ● Functional description (Section 6.), Power mode: from “(14 dB or 14.5 dB gain)” to “(13 dB or 14.5 dB gain)”. ● Typical small signal Gain (HIGH) changed from 15 dB to 14.5 dB; (LOW) changed from 14 dB to 13 dB. ● Input impedance (nom) changed from 200 Ω to 100 Ω; Condition changed from “differential (100 + 100 Ω)” to “differential (75 Ω + 25j Ω)” ● Gain (nom) changed from 13.0 dB to 12.5 dB. ● Output power (nom) changed from +20.5 to +20.0. ● Figures 20 through 24 modified. ● Note added below Figure 25.
_2	20020731	Preliminary data (9397 750 10166).
_1	20020723	Preliminary data (9397 750 10144).

+20 dBm single chip linear amplifier for WLAN**SA2411****Data sheet status**

Level	Data sheet status ^[1]	Product status ^{[2] [3]}	Definitions
I	Objective data	Development	This data sheet contains data from the objective specification for product development. Philips Semiconductors reserves the right to change the specification in any manner without notice.
II	Preliminary data	Qualification	This data sheet contains data from the preliminary specification. Supplementary data will be published at a later date. Philips Semiconductors reserves the right to change the specification without notice, in order to improve the design and supply the best possible product.
III	Product data	Production	This data sheet contains data from the product specification. Philips Semiconductors reserves the right to make changes at any time in order to improve the design, manufacturing and supply. Relevant changes will be communicated via a Customer Product/Process Change Notification (CPCN).

[1] Please consult the most recently issued data sheet before initiating or completing a design.

[2] The product status of the device(s) described in this data sheet may have changed since this data sheet was published. The latest information is available on the Internet at URL <http://www.semiconductors.philips.com>.

[3] For data sheets describing multiple type numbers, the highest-level product status determines the data sheet status.

Definitions

Short-form specification — The data in a short-form specification is extracted from a full data sheet with the same type number and title. For detailed information see the relevant data sheet or data handbook.

Limiting values definition — Limiting values given are in accordance with the Absolute Maximum Rating System (IEC 60134). Stress above one or more of the limiting values may cause permanent damage to the device. These are stress ratings only and operation of the device at these or at any other conditions above those given in the Characteristics sections of the specification is not implied. Exposure to limiting values for extended periods may affect device reliability.

Application information — Applications that are described herein for any of these products are for illustrative purposes only. Philips Semiconductors make no representation or warranty that such applications will be suitable for the specified use without further testing or modification.

Disclaimers

Life support — These products are not designed for use in life support appliances, devices, or systems where malfunction of these products can reasonably be expected to result in personal injury. Philips Semiconductors customers using or selling these products for use in such applications do so at their own risk and agree to fully indemnify Philips Semiconductors for any damages resulting from such application.

Right to make changes — Philips Semiconductors reserves the right to make changes in the products—including circuits, standard cells, and/or software—described or contained herein in order to improve design and/or performance. When the product is in full production (status 'Production'), relevant changes will be communicated via a Customer Product/Process Change Notification (CPCN). Philips Semiconductors assumes no responsibility or liability for the use of any of these products, conveys no license or title under any patent, copyright, or mask work right to these products, and makes no representations or warranties that these products are free from patent, copyright, or mask work right infringement, unless otherwise specified.

Contact information

For additional information please visit
<http://www.semiconductors.philips.com>. Fax: +31 40 27 24825

© Koninklijke Philips Electronics N.V. 2003
 All rights reserved. Printed in U.S.A.

Date of release: 02-03

For sales offices addresses send e-mail to:
sales.addresses@www.semiconductors.philips.com

Document order number:

9397 750 10825

Let's make things better.