

DATA SHEET

SA2420

Low voltage RF transceiver — 2.45GHz

Product specification

1997 May 23

Low voltage RF transceiver — 2.45 GHz

SA2420

DESCRIPTION

The SA2420 transceiver is a combined low-noise amplifier, receive mixer, transmit mixer and LO buffer IC designed for high-performance low-power communication systems for 2.4-2.5GHz applications. The LNA has a 2.5dB noise figure at 2.45GHz with 14dB gain and an IP3 intercept of -3dBm at the input. The gain is stabilized by on-chip compensation to vary less than $\pm 0.2\text{dB}$ over the -40 to +85°C temperature range. The wide-dynamic-range receive mixer has a 10.9dB noise figure and an input IP3 of +2.8dBm at 2.45GHz. The nominal current drawn from a single 3V supply is 37mA in transmit mode and 22mA in receive mode.

FEATURES

- Low current consumption: 37mA nominal transmit mode and 22mA nominal receive mode
- Fabricated on a high volume, rugged BiCMOS technology
- High system power gain: 22.5dB (LNA + Mixer) at 2.45GHz
- TSSOP24 package
- Excellent gain stability versus temperature and supply voltage
- -10dBm LO input power can be used to drive the mixer
- Operates with either full or half frequency LO
- Wide IF range: 50–500MHz

PIN CONFIGURATION

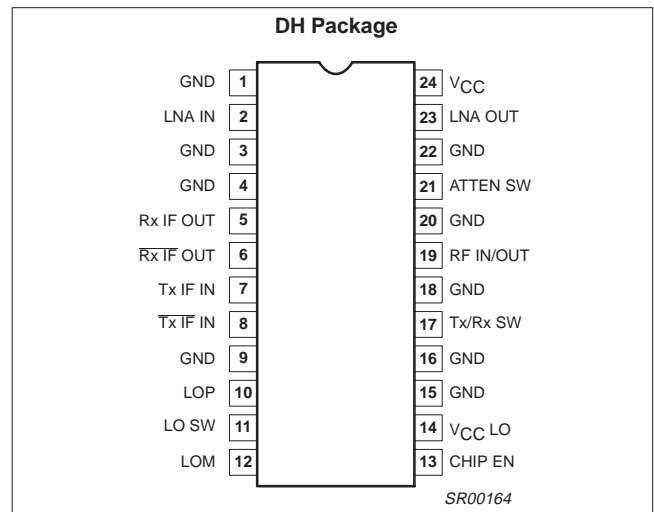

Figure 1. Pin Configuration

APPLICATIONS

- 2.45GHz WLAN front-end (802.11, ISM)

ORDERING INFORMATION

DESCRIPTION	TEMPERATURE RANGE	ORDER CODE	DWG #
24-Pin Plastic Thin Shrink Small Outline Package (Surface-mount, TSSOP)	-40 to +85°C	SA2420DH	SOT355-1

BLOCK DIAGRAM

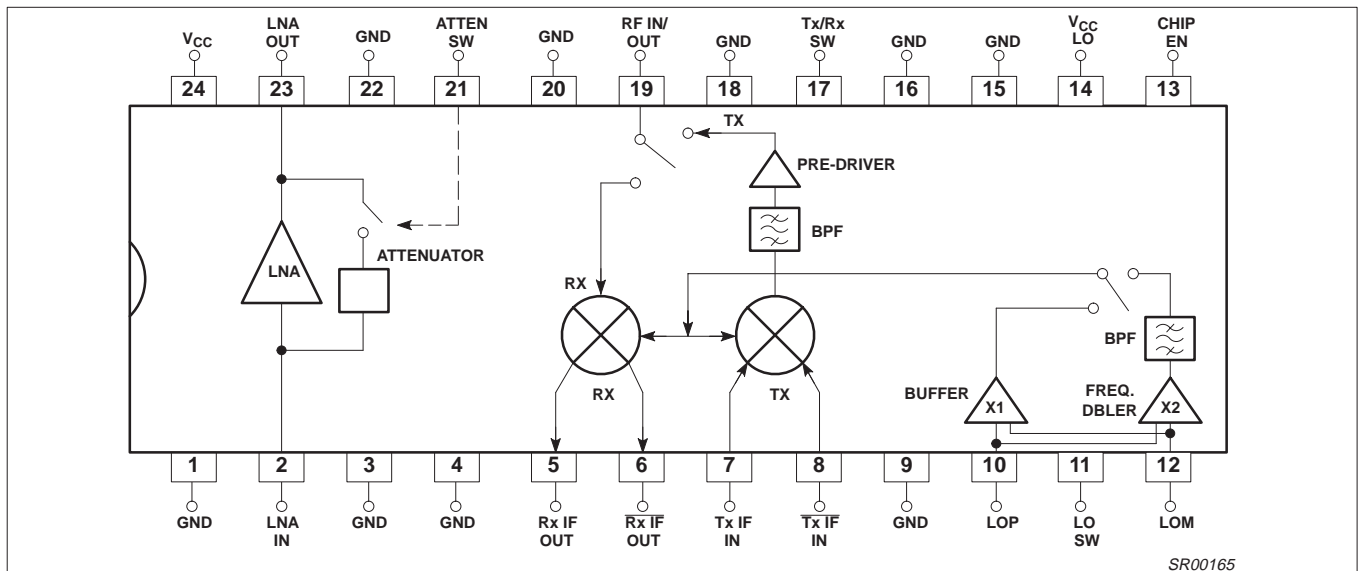

Figure 2. SA2420 Block Diagram

Low voltage RF transceiver — 2.45 GHz

SA2420

ABSOLUTE MAXIMUM RATINGS

SYMBOL	PARAMETER	RATING	UNITS
V_{CC}	Supply voltage	-0.3 to +6	V
V_{IN}	Voltage applied to any pin	-0.3 to ($V_{CC} + 0.3$)	V
P_D	Power dissipation, $T_A = 25^\circ\text{C}$ (still air) 24-Pin Plastic TSSOP	555	mW
T_{JMAX}	Maximum operating junction temperature	150	$^\circ\text{C}$
P_{MAX}	Maximum power (RF/IF/LO pins)	+20	dBm
T_{STG}	Storage temperature range	-65 to +150	$^\circ\text{C}$

NOTE:

- Transients exceeding these conditions may damage the product.
- Maximum dissipation is determined by the operating ambient temperature and the thermal resistance, and absolute maximum ratings may impact product reliability θ_{JA} : 24-Pin TSSOP = $117^\circ\text{C}/\text{W}$
- IC is protected for ESD voltages for 2000V, excepts pins 10 and 12, which are protected up to 500V.

RECOMMENDED OPERATING CONDITIONS

SYMBOL	PARAMETER	RATING	UNITS
V_{CC}	Supply voltage	2.7 to 5.5	V
T_A	Operating ambient temperature range	-40 to +85	$^\circ\text{C}$
T_J	Operating junction temperature	-40 to +105	$^\circ\text{C}$

DC ELECTRICAL CHARACTERISTICS

$V_{CC} = +3\text{V}$, $T_A = 25^\circ\text{C}$; unless otherwise stated.

SYMBOL	PARAMETER	TEST CONDITIONS	LIMITS					UNITS
			MIN	-4 σ	TYP	+4 σ	MAX	
I_{CCTX}	Supply current, Transmit	LO mode = Hi	25		37		45	mA
I_{CCRX}	Supply current, Receive	LO mode = Hi	15		22		28	mA
$I_{CC\ OFF}$	Power down mode (Tx/Rx SW = Low)	LO mode = Hi, LNA gain = Hi			0		10	μA
V_{LNA-IN}	LNA input voltage	Receive mode			0.855			V
$I_{LNA-OUT}$	LNA output bias current	Receive mode			4.0			mA
$V_{LO\ 2.1\ GHz}$	LO buffer DC input voltage	LO mode = Hi			2.1			V
$V_{LO\ 1.05\ GHz}$	LO buffer DC input voltage	LO mode = Low			2.1			V
$V_{TX\ IF}$	Tx Mixer input voltage	Transmit mode			1.7			V
$V_{TX\ IFB}$	Tx Mixer input voltage	Transmit mode			1.7			V

Low voltage RF transceiver — 2.45 GHz

SA2420

AC ELECTRICAL CHARACTERISTICS $V_{CC} = +3V$, $T_A = 25^{\circ}C$; $LO_{IN} = -10dBm$ @ 2.1GHz; $f_{RF} = 2.45GHz$; unless otherwise stated.

SYMBOL	PARAMETER	TEST CONDITIONS	LIMITS					UNITS
			MIN	-4 σ	TYP	+4 σ	MAX	
Low Noise Amplifier (In = Pin 2; Out = 23)								
S_{21}	Amplifier gain	LNA gain = Hi		12.7	14.0	15.3		dB
$\Delta S_{21}/\Delta T$	Gain temperature sensitivity	LNA gain = Hi			-0.002			dB/ $^{\circ}C$
$\Delta S_{21}/\Delta V_{CC}$	Gain V_{CC} drift	LNA gain = Hi			0.3			dB/V
S_{12}	Amplifier reverse isolation	LNA gain = Hi			-22			dB
S_{11}	Amplifier input match ¹	LNA gain = Hi			-8			dB
S_{22}	Amplifier output match ¹	LNA gain = Hi			-8			dB
ISO	Isolation: LO_1 to LNA_{IN}	LO mode = Hi, LNA gain = Hi			-45			dB
P_{-1dB}	Amplifier input 1dB gain compression	LNA gain = Hi			-15			dBm
IP3	Amplifier input third order intercept	$f_1 - f_2 = 1MHz$, LNA gain = Hi			-3			dBm
NF	Amplifier noise figure (50 Ω)	LNA gain = Hi		2.3	2.5	2.7		dB
LNA High Overload Mode								
S_{21}	Amplifier gain	LNA gain = Low		-14.0	-13.3	-12.0		dB
$\Delta S_{21}/\Delta T$	Gain temperature sensitivity	LNA gain = Low			-0.01			dB/ $^{\circ}C$
$\Delta S_{21}/\Delta V_{CC}$	Gain V_{CC} drift	LNA gain = Low			0.3			dB/V
S_{12}	Amplifier reverse isolation	LNA gain = Low			-16			dB
S_{11}	Amplifier input match ¹	LNA gain = Low			-8			dB
S_{22}	Amplifier output match ¹	LNA gain = Low			-8			dB
ISO	Isolation: LO_1 to LNA_{IN}	LO mode = Hi, LNA gain = Low			-45			dB
P_{-1dB}	Amplifier input 1dB gain compression	LNA gain = Low			+6			dBm
IP3	Amplifier input third order intercept	$f_1 - f_2 = 1MHz$, LNA gain = Low			17			dBm
NF	Amplifier noise figure (50 Ω)	LNA gain = Low			17			dB
Rx Mixer (RF = Pin 19, IF = Pins 5 and 6, LO = Pin 10 or 12, $P_{LO} = -10dBm$)								
PG_C	Power conversion gain into 50 Ω : matched to 50 Ω using external balun circuitry.	$f_S = 2.45GHz$, $f_{LO} = 2.1GHz$, $f_{IF} = 350MHz$		7.9	8.5	9.1		dB
$\Delta G_C/\Delta T$	Gain temperature drift				-0.016			dB/ $^{\circ}C$
$\Delta G_C/\Delta V_{CC}$	Gain V_{CC} drift				0.34			dB/V
S_{11-RF}	Input match at RF (2.45GHz) ¹				-15			dB
NF_M	SSB noise figure (2.45GHz) (50 Ω)			10.2	10.9	11.6		dB
P_{-1dB}	Mixer input 1dB gain compression			-11.4	-10.3	-9.2		dBm
IP3	Input third order intercept	$f_1 - f_2 = 1MHz$		1.7	2.8	3.9		dBm
f_{RF}	RF frequency range ³		2.4		2.45		2.5	GHz
f_{IF}	IF frequency range ³		300		350		400	MHz

Low voltage RF transceiver — 2.45 GHz

SA2420

AC ELECTRICAL CHARACTERISTICS (continued)

SYMBOL	PARAMETER	TEST CONDITIONS	LIMITS					UNITS
			MIN	-4 σ	TYP	+4 σ	MAX	
Rx Mixer Spurious Components (P_{IN} = P_{-1dB})								
P _{RF-IF}	RF feedthrough to IF	C _L = 2pF per side			-35			dBc
P _{LO-IF}	LO feedthrough to IF	C _L = 2pF per side			-35			dBc
Tx Mixer (RF = Pin 19, IF = Pins 7 and 8, LO = Pin 10 or 12, P_{LO} = -10dBm)								
P _{GC}	Power conversion gain: R _L = 50 Ω R _S = 50 Ω	f _S = 2.45GHz, f _{LO} = 2.1GHz, f _{IF} = 350MHz		15.0	17	19.9		dB
$\Delta G_C/\Delta T$	Gain temperature drift				-0.032			dB/°C
$\Delta G_C/\Delta V_{CC}$	Gain voltage drift				0.4			dB/V
S _{11-RF}	Output match at RF (2.45GHz) ¹				-10			dB
NF _M	SSB noise figure (2.45GHz) (50 Ω)				13.2			dB
P _{-1dB}	Output 1dB gain compression			1.5	2.9	4.3		dBm
IP3	Output third order intercept	f ₁ - f ₂ = 1MHz		10.1	+11.5	12.9		dBm
f _{RF}	RF frequency range ³		2.4		2.45		2.5	GHz
f _{IF}	IF frequency range ³		300		350		400	MHz
Tx Mixer Spurious Components (P_{OUT} = P_{-1dB})								
P _{IF-RF}	IF feedthrough to RF				-29			dBc
P _{LO-RF}	LO feedthrough to RF				-20			dBc
P _{2LO-RF}	2*LO feedthrough to RF				-25			dBc
P _{IMAGE-RF}	Image feedthrough to RF				-0			dBc
LO Buffer: Full and Half Frequency inputs								
P _{LO}	LO drive level (see figure 16)		-10		-7		5	dBm
S _{11-LO1}	Mixer input match (LO = 2.1GHz)	LO mode = Hi			-10			dB
S _{11-LO2}	Mixer input match (LO = 1.05GHz)	LO mode = Low			-10			dB
f _{LO2G}	LO2G frequency range ³	LO mode = Hi	1.9		2.1		2.3	GHz
f _{LO1G}	LO1G frequency range ³	LO mode = Low	0.85		1.05		1.25	GHz
Switching²								
t _{Rx-Tx}	Receive-to-transmit switching time				1			μ s
t _{Tx-Rx}	Transmit-to-Receive switching time				1			μ s
t _{POWER UP}	Chip enable time				1			μ s
t _{PWR DWN}	Chip disable time				1			μ s

NOTES:

1. With simple external matching
2. With 50pF coupling capacitors on all RF and IF parts
3. This part has been optimized for the frequency range at 2.4–2.5 GHz. Operation outside this frequency range may yield performance other than specified in this datasheet.

Low voltage RF transceiver — 2.45 GHz

SA2420

Table 1. Truth Table

Chip-En	TxRx-SW	LNA-SW	LO-SW	Mode	LNA Gain	LO Freq. (Typ)
0	X	X	X	Sleep	N/S	N/S
1	0	1	1	Receive	+14dB	2.1GHz
1	0	0	1	Receive	-8dB	2.1GHz
1	0	1	0	Receive	+14dB	1.05GHz
1	0	0	0	Receive	-8dB	1.05GHz
1	1	X	1	Transmit	N/S	2.1GHz
1	1	X	0	Transmit	N/S	1.05GHz

FUNCTIONAL DESCRIPTION

The SA2420 is a 2.45GHz transceiver front-end available in the TSSOP-24 package. This integrated circuit (IC) consists of a low noise amplifier (LNA) and up- and down-converters. The injection of the local oscillator (LO) signal has two options: 1) direct injection of the LO signal at approximately 2GHz, or 2) injection of an LO signal at approximately 1GHz through an on-chip doubler. The SA2420 functions with a supply voltage range of 3 – 5 V (nominally). There is an enable/disable switch available to power up/down the entire chip in 1 μ s, typically. This transceiver has several unique features.

The LNA has two operating modes: 1) high gain mode with a gain = +14dB; and 2) low gain mode with a gain <-10dB. The switch for this option is internal and is controlled externally by high and low logic to the pin. When the LNA is switched into the attenuation mode, active matching circuitry (on-chip) is switched in (reducing the number of off-chip components required). To reduce power consumption when the chip is transmitting, the LNA is automatically switched into a "sleep" mode (internally) without the use of external circuitry.

The up and down frequency converters are single-ended at the RF port of the mixers. The up and down converters share the same

(RF) pin and use an internal switch for transmitting (up-converting) or receiving (down-converting) modes. The switch is controlled externally by high and low logic states. The RF port is matched to 50 Ω and has an input IP3 of +2.8dBm (mixer only). The down-convert mixer is buffered and has open collectors at the pins to allow for matching to common SAW filters. The up-convert mixer has differential inputs (IF port) and single-ended output (RF port), with an input pin to output pin gain of 17dB. The output of the up-converter is designed for a power level = +3dBm (P_{-1dB}). The mixers are fed by the two LO options.

The available LO options are: direct injection (2.1GHz at the pin) or through an on-chip doubler. The doubler has a simple LC bandpass filter (internal) at its output which passes the second harmonic to the mixers. Through an internal switch (controlled externally), either LO can be used depending on the designer's application. If an application requires the use of a 1.05GHz VCO, then the doubler option would be used to double the frequency ($2 \times 1.05\text{GHz} = 2.1\text{GHz}$) before being injected into the mixers. For a 2.1GHz VCO, the direct option would be used. With this option, the signal passes through an on-chip buffer and is then injected into the mixers.

Low voltage RF transceiver — 2.45 GHz

SA2420

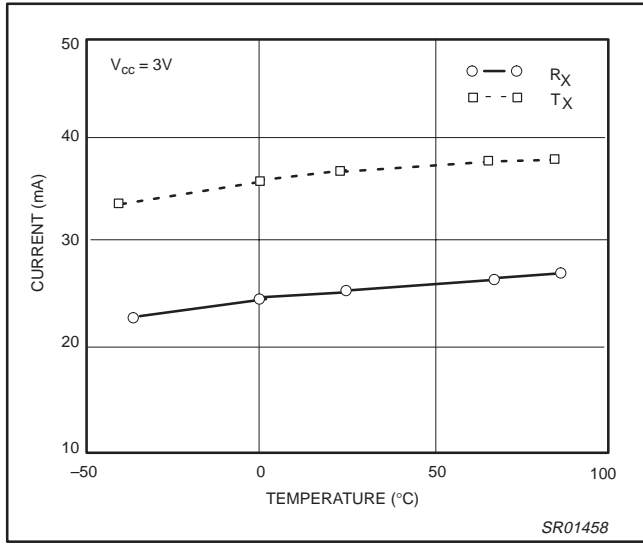

Figure 3. Rx & Tx Currents VS Temperature

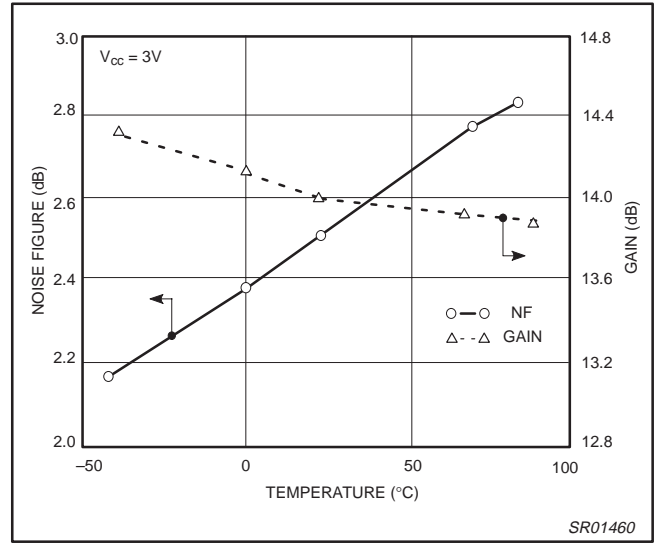

Figure 5. LNA Gain & 50Ω NF VS Temperature

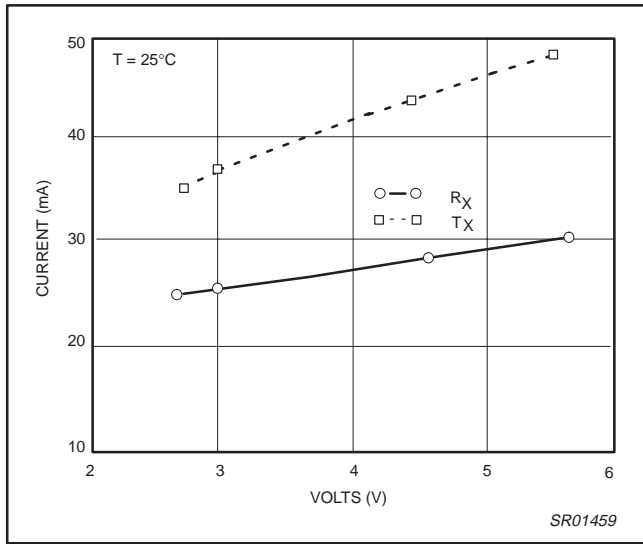

Figure 4. Rx & Tx Currents VS Voltage Supply

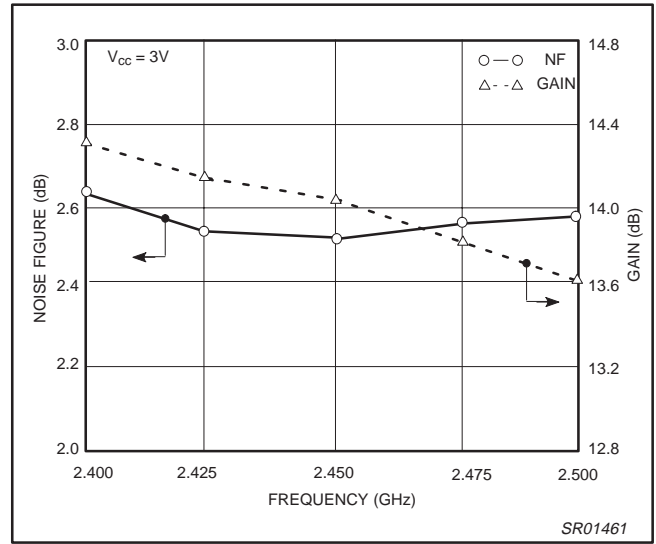

Figure 6. LNA Gain & 50Ω NF VS Frequency

Low voltage RF transceiver — 2.45 GHz

SA2420

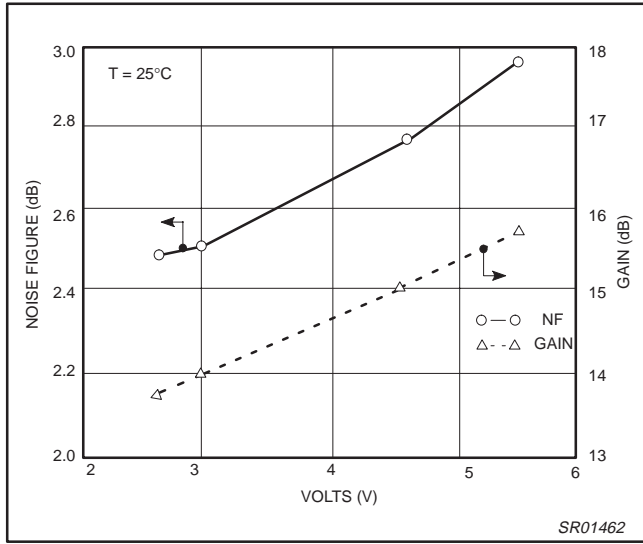

Figure 7. LNA Gain & 50Ω NF VS Supply Voltage

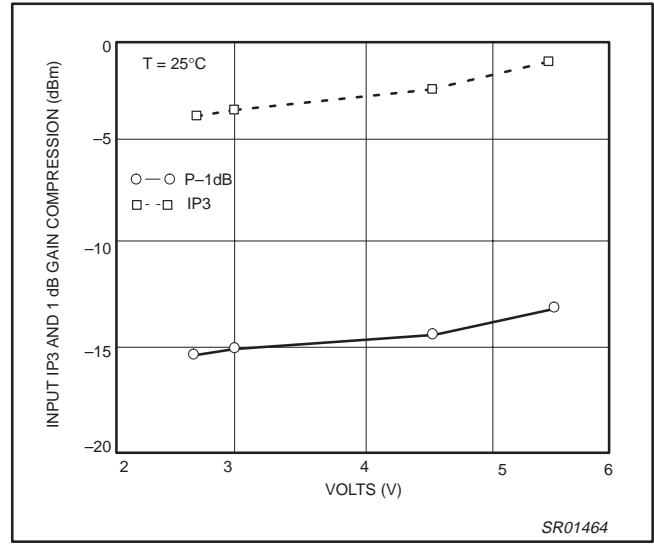

Figure 9. LNA Input IP3 and P-1dB VS Supply Voltage

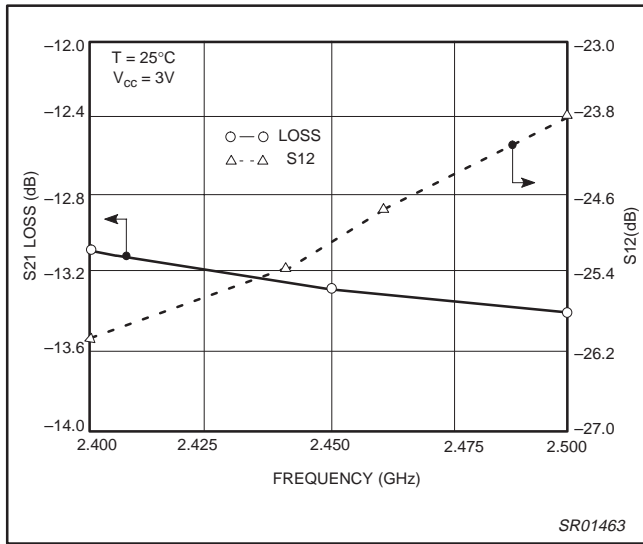

Figure 8. LNA Loss Mode & S12 VS Frequency

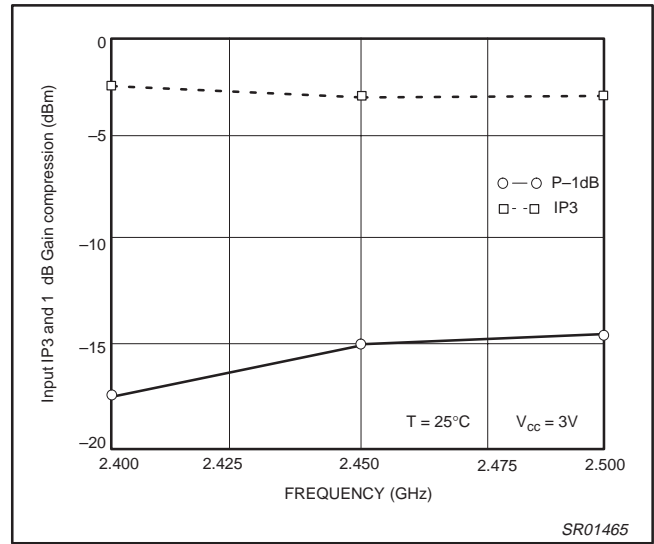

Figure 10. LNA Input IP3 and P-1dB VS Frequency

Low voltage RF transceiver — 2.45 GHz

SA2420

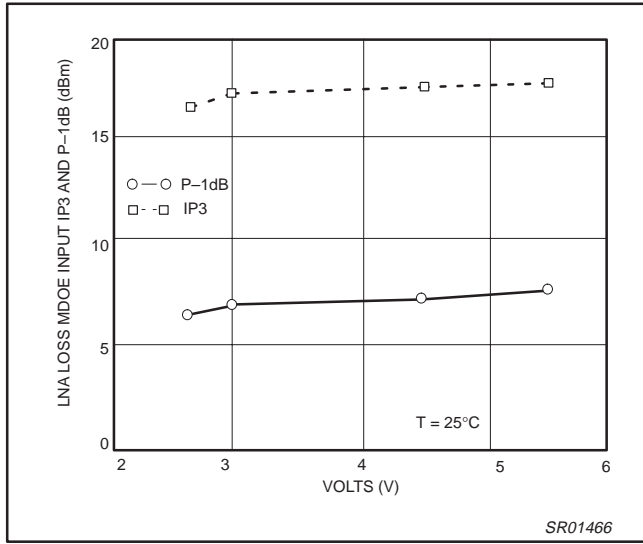

Figure 11. LNA Loss Mode Input IP3 and P-1dB VS Voltage

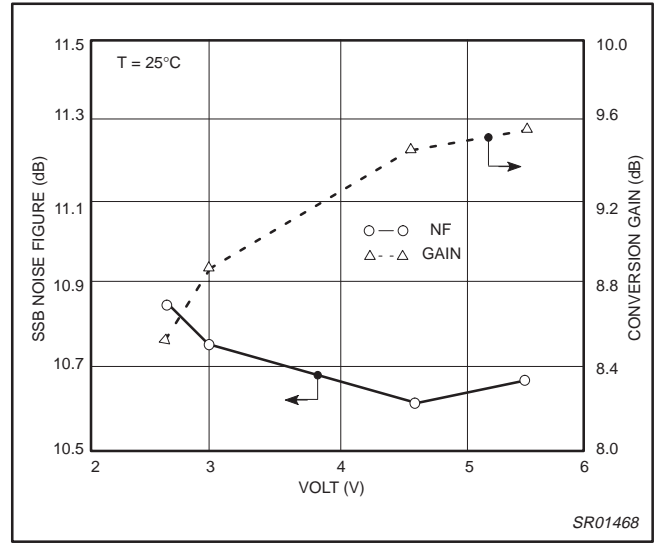

Figure 13. Rx Mixer Conv. Gain & SSB NF VS Supply Voltage

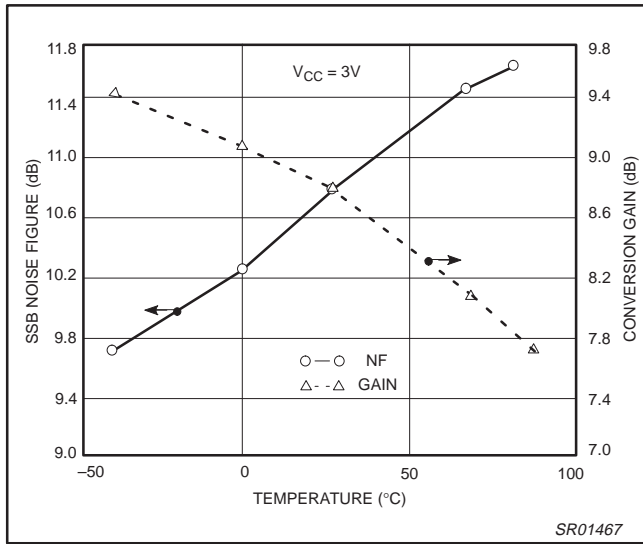

Figure 12. Rx Mixer Conv. Gain & SSB NF VS Temperature

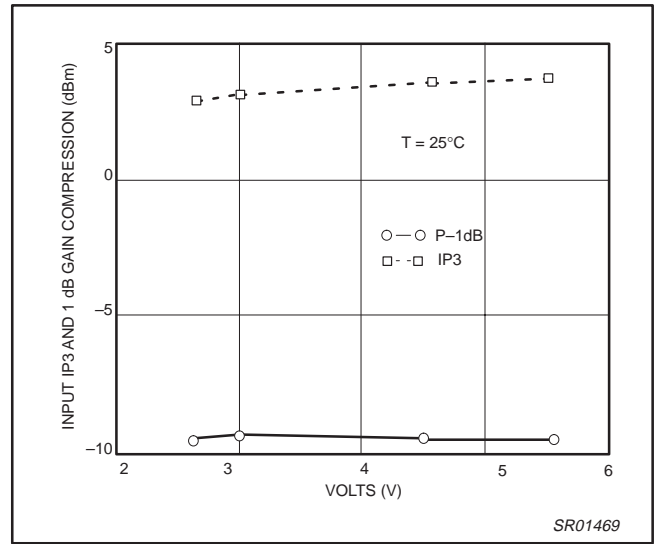

Figure 14. Rx Mixer Input IP3 and P-1dB VS Supply Voltage

Low voltage RF transceiver — 2.45 GHz

SA2420

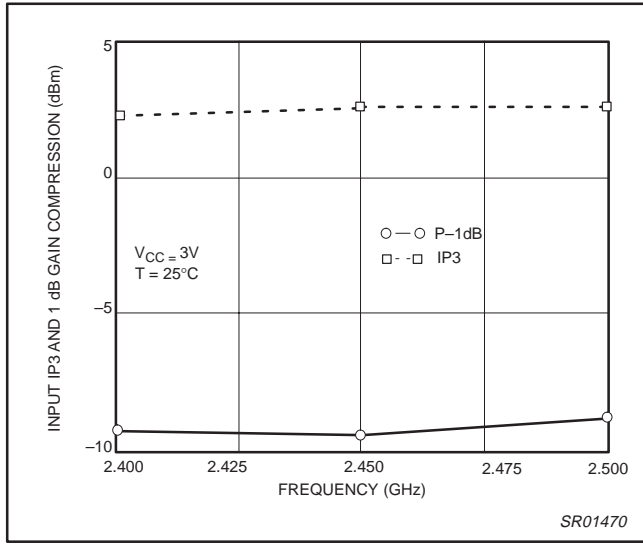

Figure 15. Rx Mixer Output IP3 and P-1dB VS Frequency

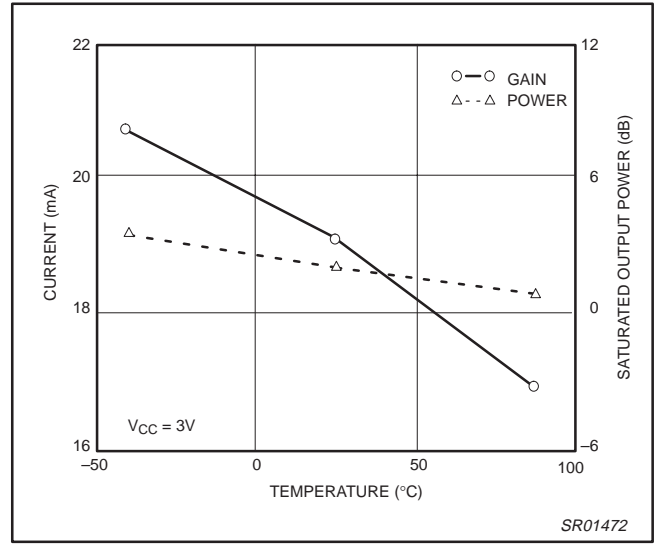

Figure 17. Tx Mx conv. Gain and Output Pwr VS Temp.

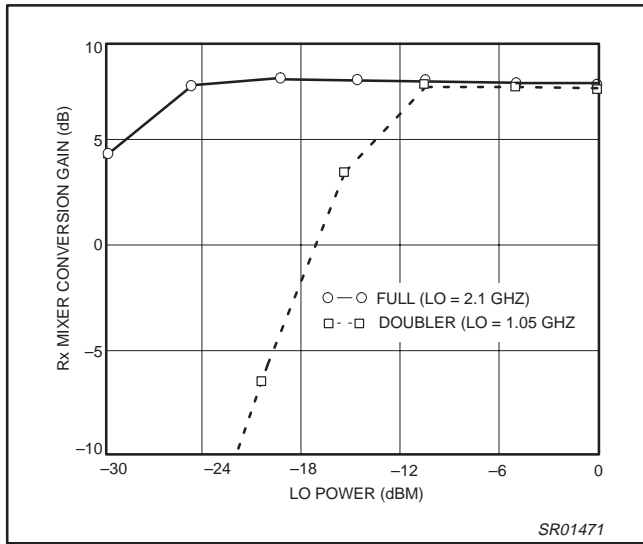

Figure 16. Rx Mixer Conversion Gain VS LO Power

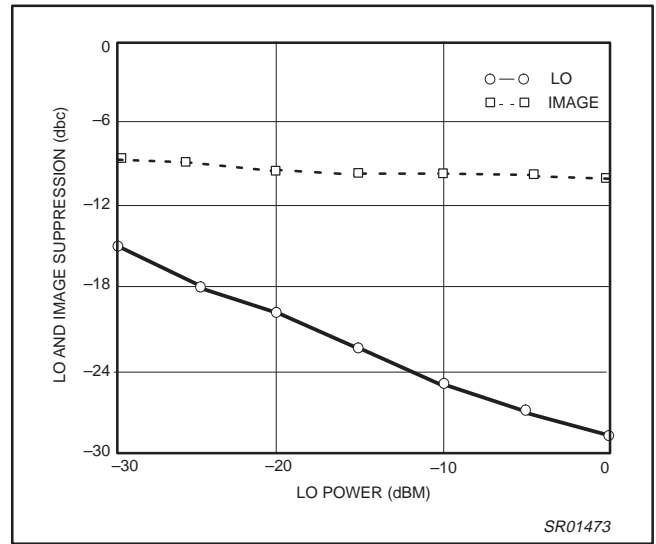

Figure 18. Tx Mixer LO and Image Suppression

Low voltage RF transceiver — 2.45 GHz

SA2420

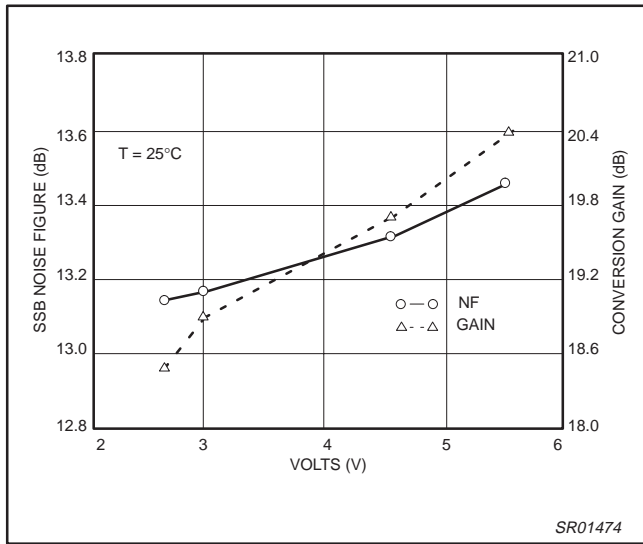

Figure 19. Tx Mixer Gain & NF VS Supply Voltage

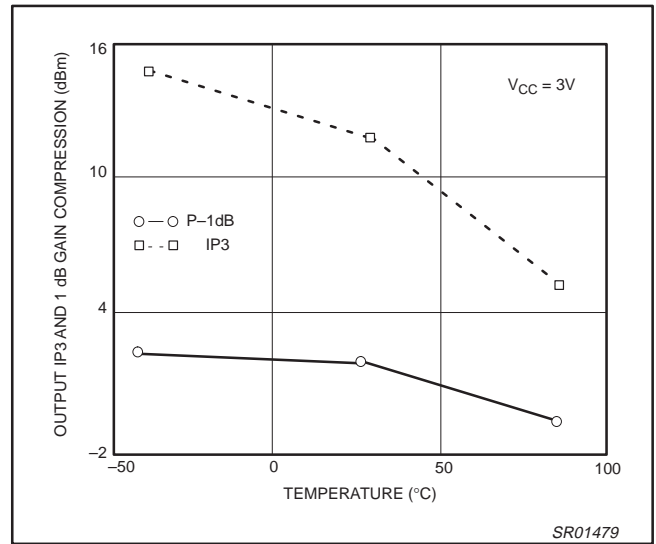

Figure 21. Tx Mixer Output IP3 and P-1dB VS Temperature

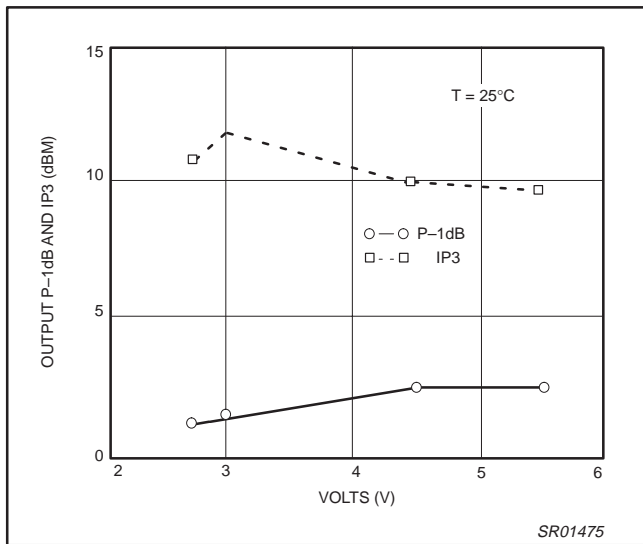

Figure 20. Tx Mixer Output P-1dB and IP3 Vs Voltage

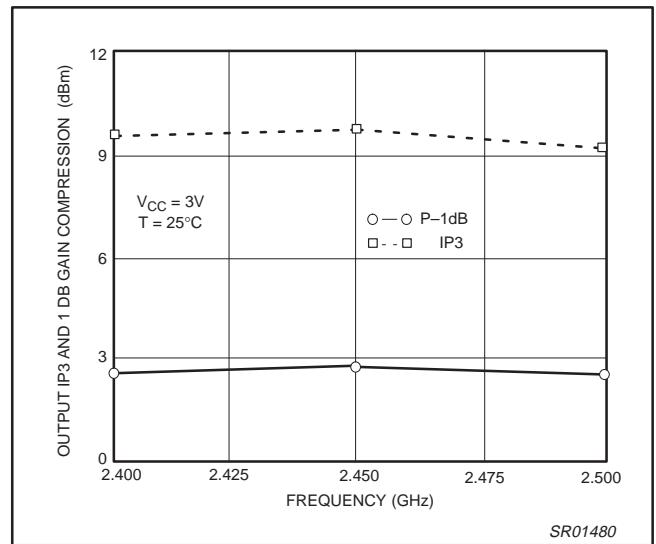

Figure 22. Tx Mixer Output IP3 and P-1dB VS Frequency

Low voltage RF transceiver — 2.45 GHz

SA2420

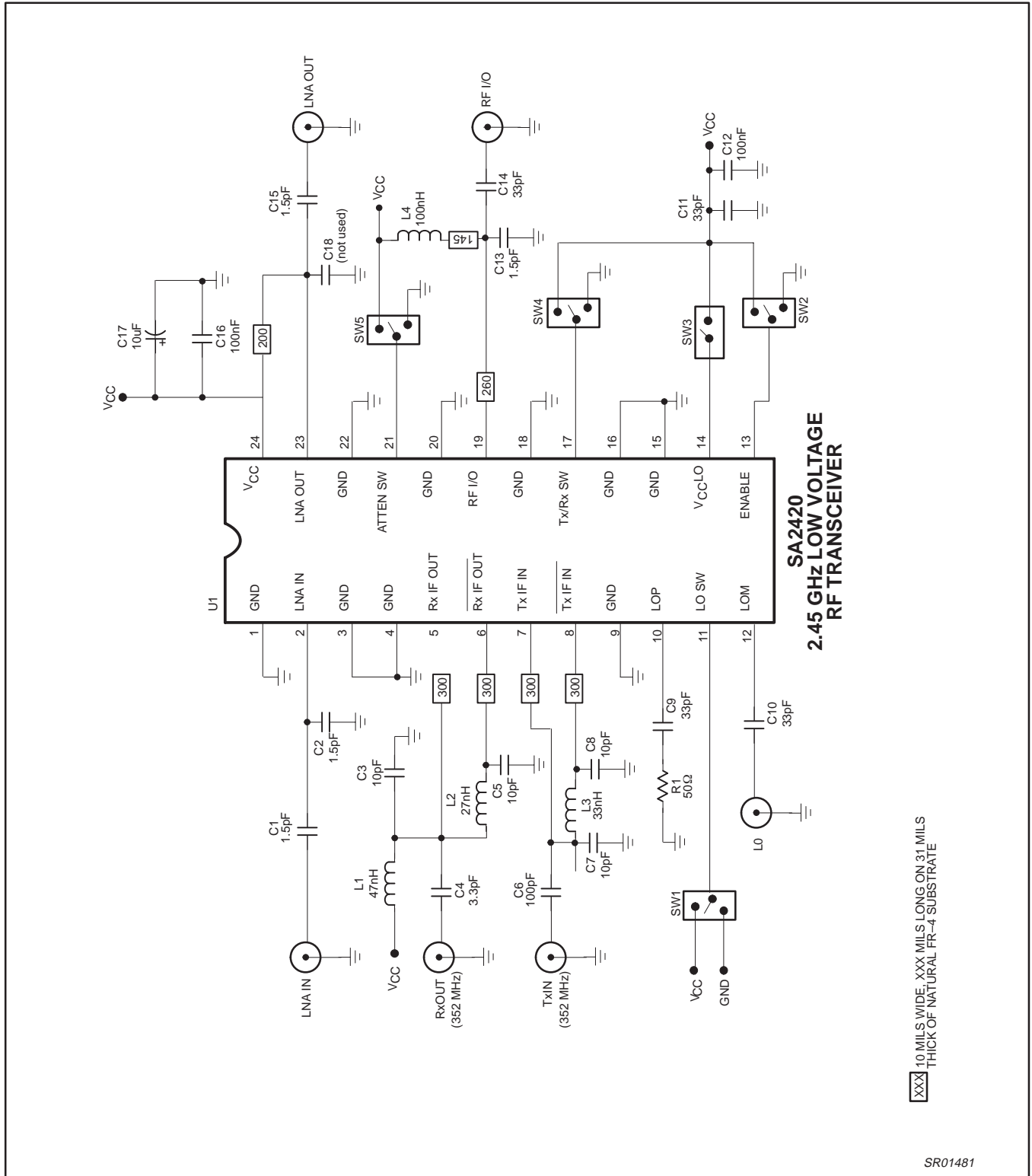

Figure 23.

Low voltage RF transceiver — 2.45 GHz

SA2420

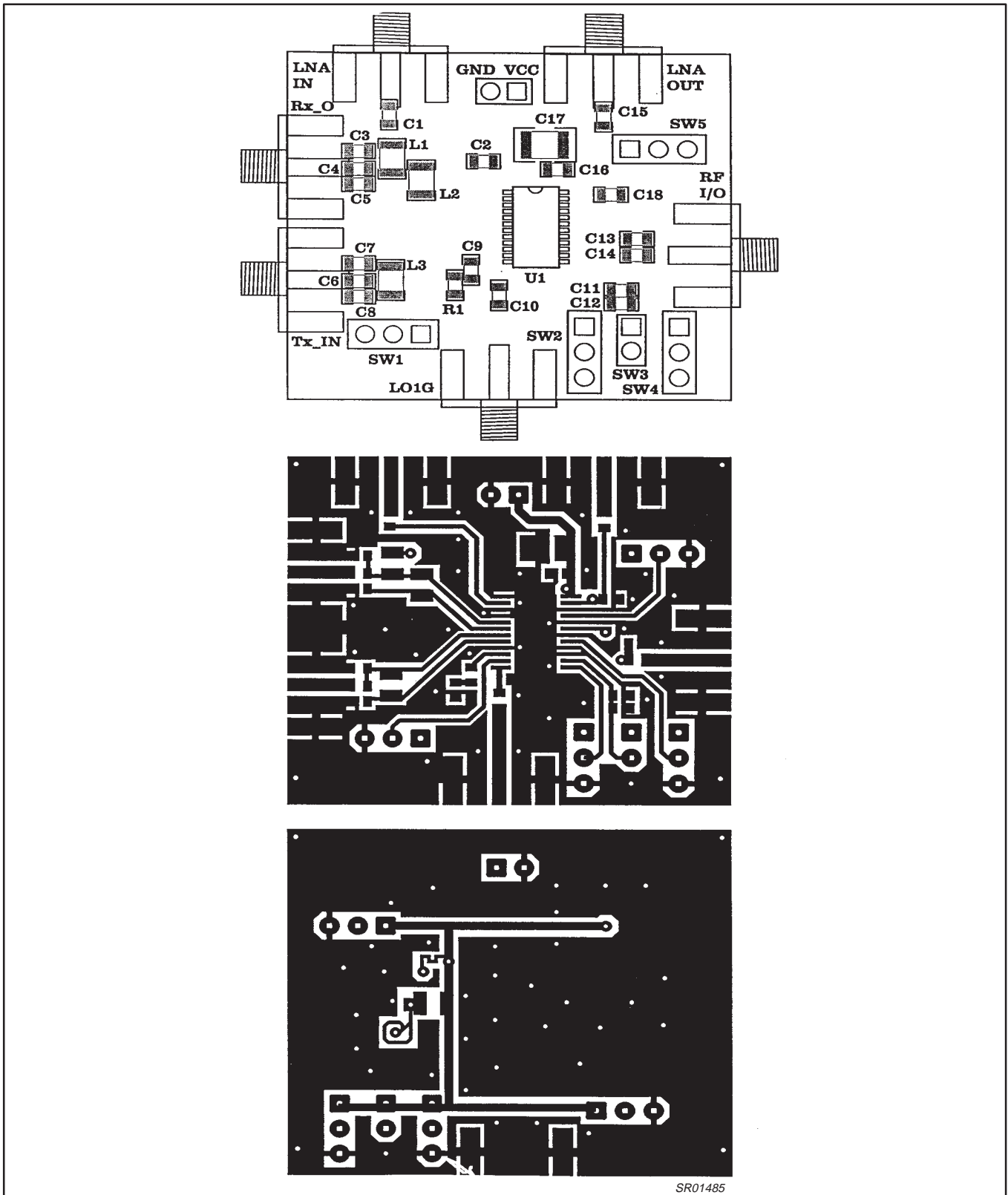

Figure 24. SA2420 RF Transceiver

Low voltage RF transceiver — 2.45GHz

SA2420

TSSOP24: plastic thin shrink small outline package; 24 leads; body width 4.4 mm

SOT355-1

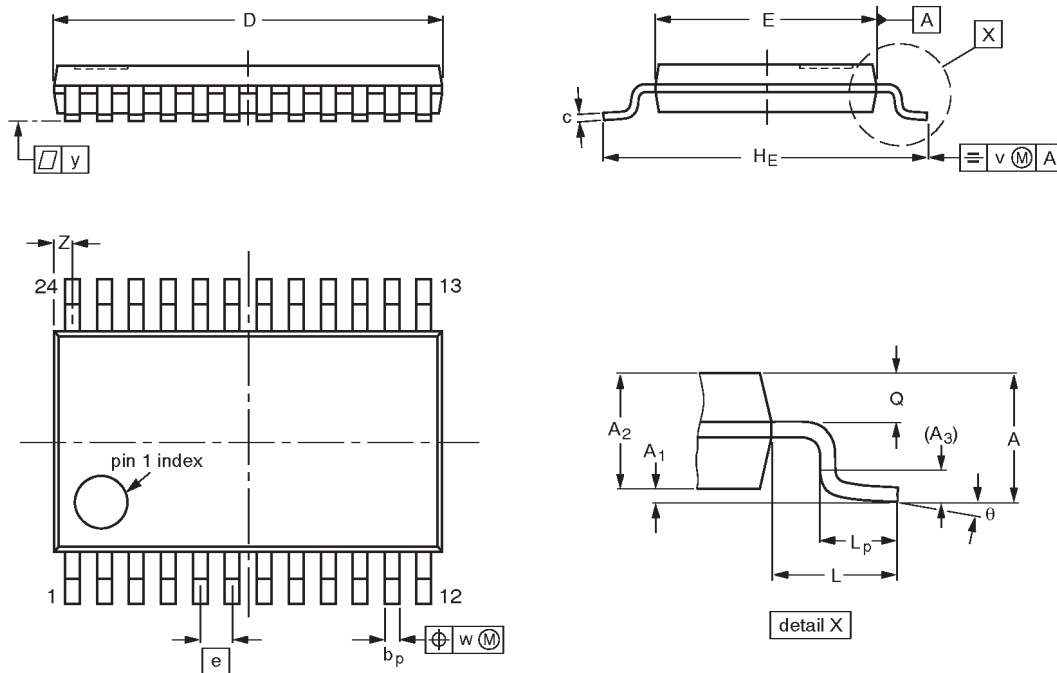

DIMENSIONS (mm are the original dimensions)

UNIT	A max.	A ₁	A ₂	A ₃	b _p	c	D ⁽¹⁾	E ⁽²⁾	e	H _E	L	L _p	Q	v	w	y	Z ⁽¹⁾	θ
mm	1.10	0.15 0.05	0.95 0.80	0.25	0.30 0.19	0.2 0.1	7.9 7.7	4.5 4.3	0.65	6.6 6.2	1.0	0.75 0.50	0.4 0.3	0.2	0.13	0.1	0.5 0.2	8° 0°

Notes

1. Plastic or metal protrusions of 0.15 mm maximum per side are not included.
2. Plastic interlead protrusions of 0.25 mm maximum per side are not included.

OUTLINE VERSION	REFERENCES				EUROPEAN PROJECTION	ISSUE DATE
	IEC	JEDEC	EIAJ			
SOT355-1		MO-153AD				-93-06-16- 95-02-04

Low voltage RF transceiver — 2.45GHz

SA2420

NOTES

Low voltage RF transceiver — 2.45GHz

SA2420

DEFINITIONS

Data Sheet Identification	Product Status	Definition
<i>Objective Specification</i>	Formative or in Design	This data sheet contains the design target or goal specifications for product development. Specifications may change in any manner without notice.
<i>Preliminary Specification</i>	Preproduction Product	This data sheet contains preliminary data, and supplementary data will be published at a later date. Philips Semiconductors reserves the right to make changes at any time without notice in order to improve design and supply the best possible product.
<i>Product Specification</i>	Full Production	This data sheet contains Final Specifications. Philips Semiconductors reserves the right to make changes at any time without notice, in order to improve design and supply the best possible product.

Philips Semiconductors and Philips Electronics North America Corporation reserve the right to make changes, without notice, in the products, including circuits, standard cells, and/or software, described or contained herein in order to improve design and/or performance. Philips Semiconductors assumes no responsibility or liability for the use of any of these products, conveys no license or title under any patent, copyright, or mask work right to these products, and makes no representations or warranties that these products are free from patent, copyright, or mask work right infringement, unless otherwise specified. Applications that are described herein for any of these products are for illustrative purposes only. Philips Semiconductors makes no representation or warranty that such applications will be suitable for the specified use without further testing or modification.

LIFE SUPPORT APPLICATIONS

Philips Semiconductors and Philips Electronics North America Corporation Products are not designed for use in life support appliances, devices, or systems where malfunction of a Philips Semiconductors and Philips Electronics North America Corporation Product can reasonably be expected to result in a personal injury. Philips Semiconductors and Philips Electronics North America Corporation customers using or selling Philips Semiconductors and Philips Electronics North America Corporation Products for use in such applications do so at their own risk and agree to fully indemnify Philips Semiconductors and Philips Electronics North America Corporation for any damages resulting from such improper use or sale.

Philips Semiconductors
811 East Arques Avenue
P.O. Box 3409
Sunnyvale, California 94088-3409
Telephone 800-234-7381

Date of release: 05-97

Document order number:

9397 750 03302

Let's make things better.