



SB07W03V

30V, 700mA Rectifier

Applications

- Universal-use rectifier.
- High frequency rectification (switching regulators, converters, choppers).

Features

- Low forward voltage ($V_F \text{ max}=0.55\text{V}$).
- Fast reverse recovery time ($t_{rr} \text{ max}=10\text{ns}$).
- Low switching noise.
- Low leakage current and high reliability due to highly reliable planar structure.

Absolute Maximum Ratings at $T_a=25^\circ\text{C}$ (Value per element)

			unit
Repetitive Peak Reverse Voltage	V_{RRM}	30	V
Nonrepetitive Peak Reverse	V_{RSM}	35	V
Surge Voltage			
Average Output Current	I_o	700	mA
Surge Forward Current	I_{FSM}	5	A
		50Hz sine wave, 1 cycle	
Junction Temperature	T_j	-55 to +125	$^\circ\text{C}$
Storage Temperature	T_{stg}	-55 to +125	$^\circ\text{C}$

Electrical Characteristics at $T_a=25^\circ\text{C}$ (Value per element)

			min	typ	max	unit
Reverse Voltage	V_R	$I_R=300\mu\text{A}$	30			V
Forward Voltage	V_F	$I_F=700\text{mA}$			0.55	V
Reverse Current	I_R	$V_R=15\text{V}$			50	μA
Interterminal Capacitance	c	$V_R=10\text{V}, f=1\text{MHz}$		28		pF
Reverse Recovery Time	t_{rr}	$I_F=I_R=100\text{mA}$, See specified Test Circuit.			10	ns
Thermal Resistance	R_{thj-a}			120		$^\circ\text{C/W}$

t_{rr} Test Circuit

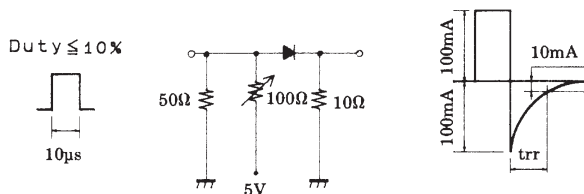

Electrical Connection

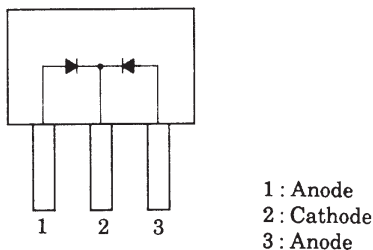

Package Dimensions 1238A

(unit : mm)

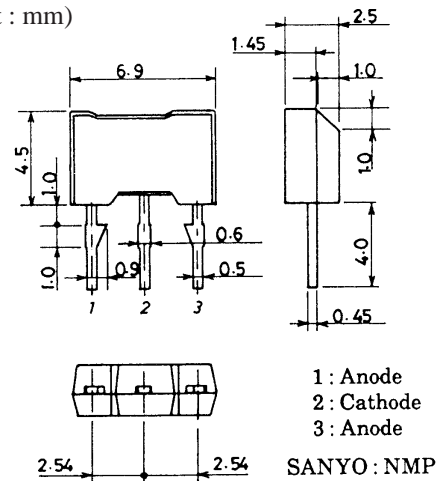

1 : Anode
2 : Cathode
3 : Anode

SANYO : NMP

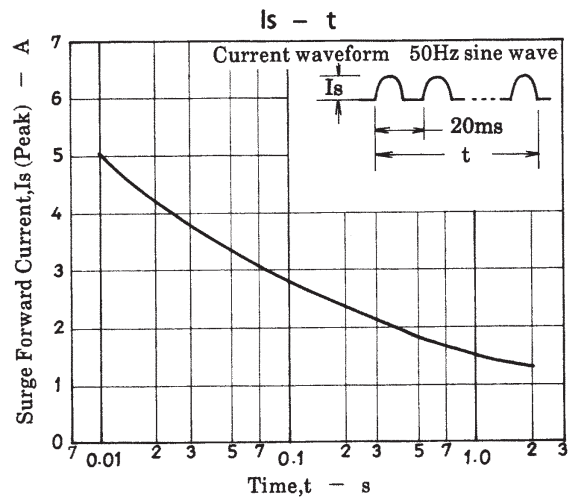
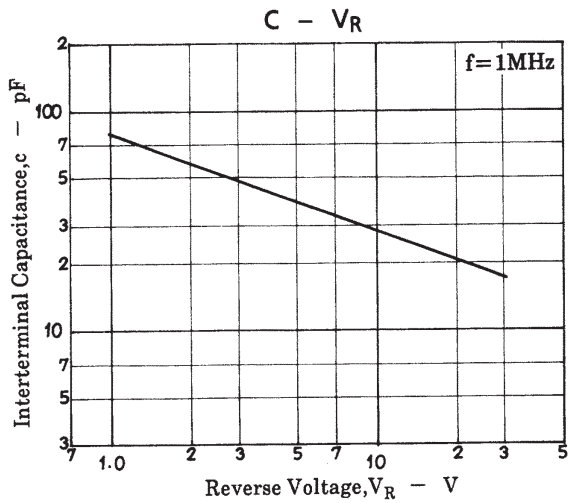
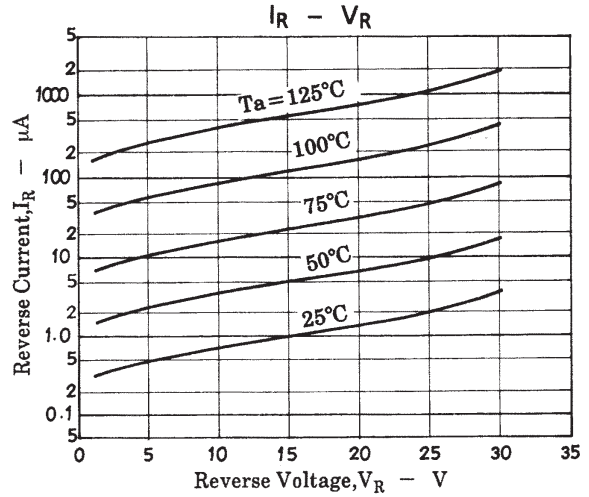
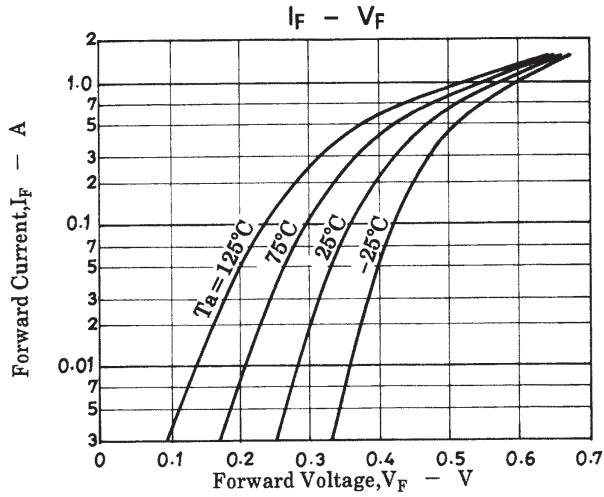

- No products described or contained herein are intended for use in surgical implants, life-support systems, aerospace equipment, nuclear power control systems, vehicles, disaster/crime-prevention equipment and the like, the failure of which may directly or indirectly cause injury, death or property loss.
- Anyone purchasing any products described or contained herein for an above-mentioned use shall:
 - ① Accept full responsibility and indemnify and defend SANYO ELECTRIC CO., LTD., its affiliates, subsidiaries and distributors and all their officers and employees, jointly and severally, against any and all claims and litigation and all damages, cost and expenses associated with such use:
 - ② Not impose any responsibility for any fault or negligence which may be cited in any such claim or litigation on SANYO ELECTRIC CO., LTD., its affiliates, subsidiaries and distributors or any of their officers and employees jointly or severally.
- Information (including circuit diagrams and circuit parameters) herein is for example only; it is not guaranteed for volume production. SANYO believes information herein is accurate and reliable, but no guarantees are made or implied regarding its use or any infringements of intellectual property rights or other rights of third parties.

This catalog provides information as of June, 1997. Specifications and information herein are subject to change without notice.