

Product Description

Stanford Microdevices' SCA-16 is a high performance Gallium Arsenide Heterojunction Bipolar Transistor MMIC Amplifier. A Darlington configuration is utilized for broadband performance up to 3 GHz. The heterojunction increases breakdown voltage and minimizes leakage current between junctions. Cancellation of emitter junction non-linearities results in higher suppression of intermodulation products. Typical IP3 at 50mA is +28dBm.

These unconditionally stable amplifiers provides 15dB of gain and +14.5dBm of 1dB compressed power and requires only a single positive voltage supply. Only 2 DC-blocking capacitors, a bias resistor and an optional inductor are needed for operation.

This MMIC is an ideal choice for wireless applications such as cellular, PCS, CDPD, wireless data and SONET.

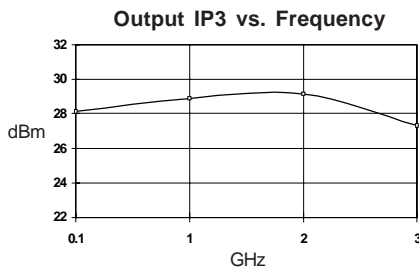

Electrical Specifications at Ta = 25C

Symbol	Parameters: Test Conditions: Id = 50 mA, Z ₀ = 50 Ohms		Units	Min.	Typ.	Max.
G _P	Power Gain	f = 0.1-2.0 GHz f = 2.0-3.0 GHz	dB dB	13	15 14	
G _F	Gain Flatness Gain Flatness over any 100 MHz band	f = 0.1-2.0 GHz	dB dB		+/- 0.7 +/- 0.1	
P _{1dB}	Output Power at 1dB Compression	f = 0.1-2.0 GHz	dBm		14.5	
NF	Noise Figure	f = 0.1-3.0 GHz	dB		5.5	
VSWR	Input and Output VSWR	f = 0.1-3.0 GHz	-		1.5	
IP ₃	Third Order Intercept Point Output Tone @ 0dBm 10 MHz Apart	f = 0.1-2.0 GHz	dBm		28.0	
T _D	Group Delay	f = 1.9 GHz	psec		100	
ISOL	Reverse Isolation	f = 0.1-3.0 GHz	dB		20	
VD	Device Voltage		V	3.5	4.0	4.5
dG/dT	Device Gain Temperature Coefficient		dB/degC		-0.0018	
dV/dT	Device Voltage Temperature Coefficient		mV/degC		-4.0	

The information provided herein is believed to be reliable at press time. Stanford Microdevices assumes no responsibility for inaccuracies or omissions. Stanford Microdevices assumes no responsibility for the use of this information, and all such information shall be entirely at the user's own risk. Prices and specifications are subject to change without notice. No patent rights or licenses to any of the circuits described herein are implied or granted to any third party. Stanford Microdevices does not authorize or warrant any Stanford Microdevices product for use in life-support devices and/or systems. Copyright 1999 Stanford Microdevices, Inc. All worldwide rights reserved.

SCA-16

DC-3 GHz, Cascadable GaAs HBT MMIC Amplifier



Product Features

- High Output IP3 : +28dBm
- Flat Gain : +/- 0.7dB Over Full Band
- Cascadable 50 Ohm : 1.5:1 VSWR
- Patented GaAsHBT Technology
- Operates From Single Supply
- Low Thermal Resistance Package

Applications

- Cellular, PCS, CDPD
- Wireless Data, SONET

SCA-16 DC-3 GHz Cascadable MMIC Amplifier

Typical Performance at 25° C ($V_{ds} = 4.0V$, $I_{ds} = 50mA$)

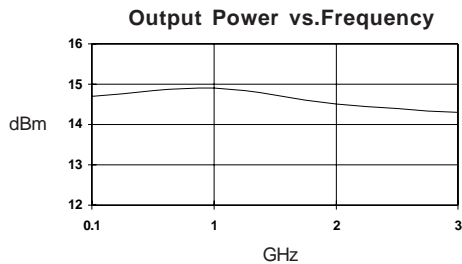
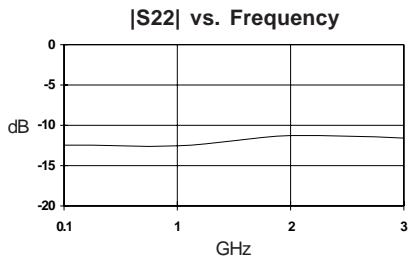
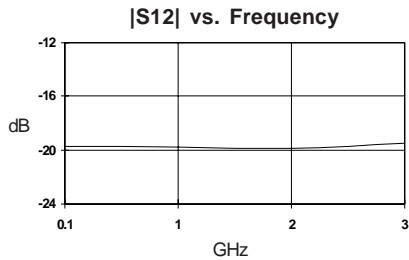
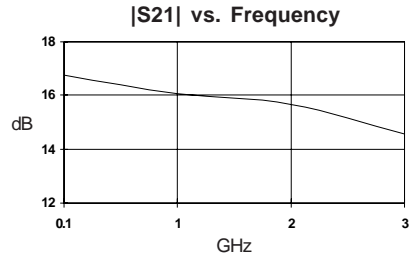
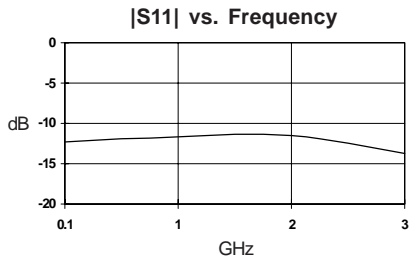

Typical S-Parameters $V_{ds} = 4.0V$, $I_d = 50mA$

Freq GHz	S11	S11 Ang	S21	S21 Ang	S12	S12 Ang	S22	S22 Ang
.100	0.247	125	6.531	148	0.108	-42	0.212	124
.500	0.241	117	6.606	136	0.103	-31	0.206	117
.900	0.256	70	6.397	103	0.102	-55	0.228	71
1.00	0.260	58	6.362	93	0.103	-61	0.235	59
1.50	0.272	3	6.174	52	0.102	-93	0.260	3
2.00	0.265	-50	6.078	10	0.101	-122	0.273	-52
2.50	0.240	-104	5.638	-32	0.104	-153	0.274	-109
3.00	0.204	-160	5.343	-70	0.106	172	0.264	-167

(S-Parameters include the effects of two 1.0 mil diameter bond wires, each 20 mils long, connected to the gate and drain pads on the die)

Absolute Maximum Ratings

Parameter	Absolute Maximum
Device Current	75 mA
Power Dissipation	350 mW
RF Input Power	100 mW
Junction Temperature	+200°C
Operating Temperature	-45°C to +85°C
Storage Temperature	-65°C to +150°C

Notes:

- Operation of this device above any one of these parameters may cause permanent damage.

Recommended Bias Resistor Values						
Supply Voltage (Vs)	5V	7.5V	9V	12V	15V	20V
Rbias (Ohms)	20	70	100	160	220	320

Mounting Instructions

The data shown was taken on a 31mil thick FR-4 board with 1 ounce of copper on both sides. The board was mounted to a baseplate with 3 screws as shown. The screws bring the top side copper temperature to the same value as the baseplate.

- Use 1 or 2 ounce copper, if possible.
- Solder the copper pad on the backside of the device package to the ground plane.
- Use a large ground pad area with many plated through-holes as shown.
- If possible, use at least one screw no more than 0.2 inch from the device package to provide a low thermal resistance path to the baseplate of the package.
- Thermal resistance from ground lead to screws is 2 deg. C/W.

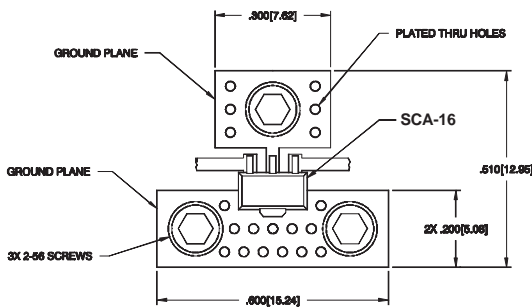

DIMENSIONS ARE IN INCHES [MM]

MTTF vs. Temperature @ Id = 50mA

Lead Temperature	MTTF (hrs)
+55°C	1,000,000
+90°C	100,000
+120°C	10,000

Thermal Resistance (Lead-Junction): 510° C/W

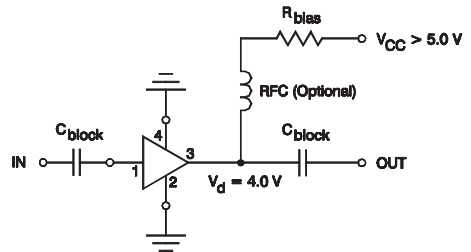

Typical Biasing Configuration

Pin Designation	
1	RF in
2	GND
3	RF out and Bias
4	GND

Outline Drawing

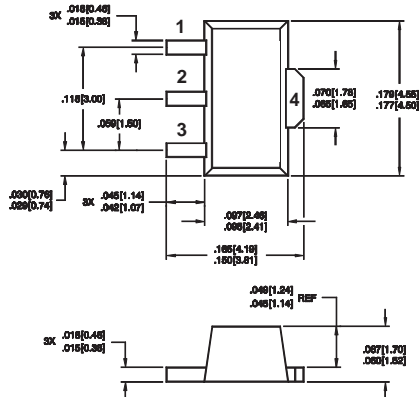

DIMENSIONS ARE IN INCHES [MM]

Pin assignments shown for reference only, not marked on part