

### Description

- Six sizes of shielded drum core inductors with low profiles (as low as 1.0mm) and high power density
- Inductance range from .47uH to 1000uH
- Current range from 6.00 to 0.088 Amps
- Ferrite shielded, low EMI

### Applications

- Digital cameras, CD players, cellular phones, and PDAs
- PCMCIA cards
- GPS systems

### Environmental Data

- Storage temperature range: -40C to +125C
- Operating ambient temperature range: -40C to +85C (range is application specific). Temperature rise is approximately 40C at rated rms current
- Infrared reflow temperature: +240C for 30 seconds maximum

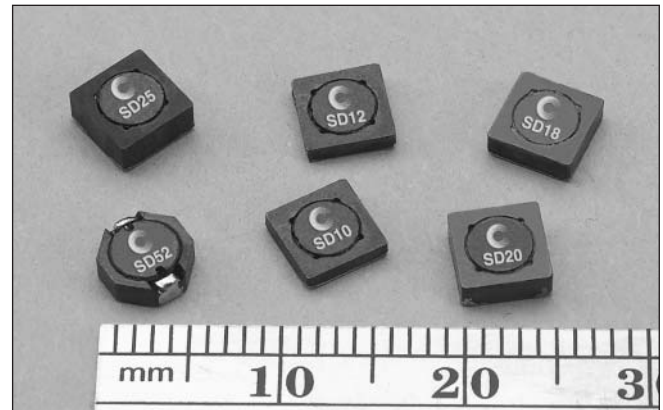

### Packaging

- Supplied in tape and reel packaging, 3800 (SD10, SD12 and SD18), 2900 (SD20 and SD25), and 3500 (SD52) per reel

Part Number	Rated Inductance (µH)	OCL (1) +/-20% (µH)	Part Marking	Irms (2) Amperes	Isat (3) Amperes	DCR (4) (Ω) Typ.	Volt u-sec Typ.
SD10-R47	0.470	0.453	A	2.59	3.54	0.0249	2.1
SD10-1R0	1.00	1.119	B	1.93	2.25	0.0448	3.3
SD10-1R5	1.50	1.563	C	1.60	1.91	0.0653	3.9
SD10-2R2	2.20	2.081	D	1.35	1.65	0.0912	4.5
SD10-3R3	3.30	3.339	E	1.24	1.31	0.1078	5.7
SD10-4R7	4.70	4.893	F	1.04	1.08	0.1535	6.9
SD10-6R2	6.20	6.743	G	0.94	0.92	0.1870	8.1
SD10-8R2	8.20	8.889	H	0.800	0.800	0.2607	9.3
SD10-100	10.0	10.07	J	0.760	0.752	0.2888	9.9
SD10-150	15.0	15.55	K	0.613	0.605	0.4429	12.3
SD10-220	22.0	22.21	L	0.498	0.506	0.6718	14.7
SD10-330	33.0	32.20	M	0.412	0.420	0.9807	17.7
SD10-470	47.0	46.63	N	0.337	0.349	1.47	21.3
SD10-680	68.0	70.01	O	0.301	0.285	1.84	26.1
SD10-820	82.0	83.48	P	0.258	0.261	2.50	28.5
SD10-101	100	102.0	Q	0.225	0.236	3.29	31.5
SD10-151	150	149.2	R	0.200	0.195	4.15	38.1
SD10-221	220	222.2	S	0.161	0.160	6.41	46.5
SD10-331	330	330.4	T	0.130	0.131	9.83	56.7
SD10-471	470	468.3	U	0.117	0.110	12.10	67.5
SD12-R47	0.470	0.490	A	3.19	3.86	0.0246	2.84
SD12-1R2	1.20	1.21	B	2.62	2.45	0.0366	4.47
SD12-1R5	1.50	1.69	C	2.19	2.08	0.0521	5.28
SD12-2R2	2.20	2.25	D	1.83	1.80	0.0747	6.09
SD12-3R3	3.30	3.61	E	1.55	1.42	0.1043	7.71
SD12-4R7	4.70	4.41	F	1.46	1.29	0.1177	8.53
SD12-6R2	6.20	6.25	G	1.21	1.08	0.1699	10.15
SD12-8R2	8.20	8.41	H	1.02	0.931	0.2399	11.77
SD12-100	10.0	10.89	J	0.938	0.818	0.2844	13.40
SD12-150	15.0	15.21	K	0.782	0.692	0.4089	15.83
SD12-220	22.0	22.09	L	0.628	0.574	0.6338	19.08
SD12-330	33.0	32.49	M	0.519	0.474	0.9289	23.14
SD12-470	47.0	47.61	N	0.428	0.391	1.37	28.01
SD12-680	68.0	68.89	O	0.341	0.325	2.16	33.70
SD12-820	82.0	82.81	P	0.326	0.297	2.36	36.95
SD12-101	100	98.0	Q	0.308	0.273	2.64	40.19
SD12-151	150	151.3	R	0.251	0.220	3.96	49.94

(1) Open Circuit Inductance Test Parameters: 100KHz, 0.25Vrms, 0.0Aac.

(2) RMS current for an approximate ΔT of 40°C without core loss. It is recommended that the temperature of the part not exceed 125°C.

(3) Peak current for approximate 30% roll off at 20°C.

(4) DCR limits @ 20°C.

(5) Applied Volt-Time product (V-uS) across the inductor at 100kHz necessary to generate a core loss equal to 10% of the total losses for 40°C temperature rise.

Part Number	Rated Inductance (μH)	OCL (1) +/-20% (μH)	Part Marking	Irms (2) Amperes	Isat (3) Amperes	DCR (4) (Ω) Typ.	Volt u-sec Typ.
SD12-221	220	222.0	S	0.229	0.181	4.76	60.49
SD12-331	330	334.9	T	0.186	0.148	7.25	74.30
SD12-471	470	462.3	U	0.167	0.126	8.95	87.29
SD12-681	680	670.8	V	0.149	0.104	11.30	105
SD12-821	820	800.9	W	0.129	0.095	14.93	115
SD12-102	1000	992.3	X	0.121	0.086	17.20	128
SD18-R47	0.47	0.49	A	3.58	4.63	0.0201	2.35
SD18-R82	0.82	0.81	B	3.24	3.60	0.0247	3.02
SD18-1R2	1.20	1.21	C	2.97	2.95	0.0294	3.70
SD18-1R5	1.50	1.69	D	2.73	2.49	0.0345	4.37
SD18-2R2	2.20	2.25	E	2.55	2.16	0.0398	5.04
SD18-3R3	3.30	3.61	F	2.07	1.71	0.0605	6.38
SD18-4R7	4.70	4.41	G	1.77	1.54	0.0824	7.06
SD18-6R2	6.20	6.25	H	1.61	1.30	0.1000	8.40
SD18-8R2	8.20	8.41	J	1.38	1.12	0.1351	9.74
SD18-100	10.0	10.89	K	1.28	0.982	0.1584	11.09
SD18-150	15.0	15.21	L	1.06	0.831	0.2278	13.10
SD18-220	22.0	22.09	M	0.876	0.689	0.3366	15.79
SD18-330	33.0	32.49	N	0.715	0.568	0.5057	19.15
SD18-470	47.0	47.61	O	0.578	0.470	0.7732	23.18
SD18-680	68.0	68.89	P	0.514	0.390	0.9798	27.89
SD18-820	82.0	82.81	Q	0.446	0.356	1.30	30.58
SD18-101	100	102.01	R	0.419	0.321	1.47	33.94
SD18-151	150	151.29	S	0.345	0.263	2.18	41.33
SD18-221	220	222.01	T	0.296	0.217	2.95	50.06
SD18-331	330	334.89	U	0.248	0.177	4.20	61.49
SD18-471	470	479.61	V	0.201	0.148	6.39	73.58
SD18-681	680	681.21	W	0.167	0.124	9.28	87.70
SD18-821	820	823.69	X	0.145	0.113	12.35	96.43
SD18-102	1000	1004	Y	0.136	0.102	14.01	107
SD20-R47	0.47	0.490	A	3.59	4.00	0.0200	2.28
SD20-1R2	1.20	1.21	B	3.07	2.55	0.0275	3.58
SD20-1R5	1.50	1.69	C	2.88	2.15	0.0312	4.23
SD20-2R2	2.20	2.25	D	2.45	1.87	0.0429	4.88
SD20-3R3	3.30	3.61	E	2.17	1.47	0.0547	6.18
SD20-4R7	4.70	4.41	F	2.05	1.33	0.0612	6.83
SD20-6R2	6.20	6.25	G	1.89	1.12	0.0720	8.13
SD20-8R2	8.20	8.41	H	1.61	0.966	0.1000	9.43
SD20-100	10.0	9.61	J	1.53	0.903	0.1100	10.08
SD20-150	15.0	15.21	K	1.25	0.718	0.1655	12.68
SD20-220	22.0	22.09	L	1.12	0.596	0.2053	15.28
SD20-330	33.0	32.49	M	0.913	0.491	0.3100	18.53
SD20-470	47.0	47.61	N	0.745	0.406	0.4650	22.43
SD20-680	68.0	68.89	O	0.610	0.337	0.6947	26.98
SD20-820	82.0	82.81	P	0.576	0.308	0.7785	29.58
SD20-101	100	98.01	Q	0.495	0.283	1.06	32.18
SD20-151	150	151.3	R	0.435	0.228	1.37	39.98
SD20-221	220	222.0	S	0.356	0.188	2.04	48.43
SD20-331	330	327.6	T	0.294	0.155	2.99	58.83
SD20-471	470	470.9	U	0.263	0.129	3.74	70.53
SD20-681	680	681.2	V	0.216	0.107	5.56	84.83
SD20-821	820	823.7	W	0.204	0.098	6.22	93.28
SD20-102	1000	1004.9	X	0.172	0.088	8.73	103
SD25-R47	0.47	0.466	A	3.88	6.00	0.0177	2.13
SD25-R82	0.82	0.770	B	3.58	4.67	0.0208	2.74
SD25-1R2	1.20	1.15	C	3.33	3.81	0.0240	3.34
SD25-1R5	1.50	1.61	D	3.12	3.23	0.0274	3.95
SD25-2R2	2.20	2.14	E	2.93	2.80	0.0311	4.56

(1) Open Circuit Inductance Test Parameters: 100KHz, 0.25Vrms, 0.0Adc.  
(2) RMS current for an approximate ΔT of 40°C without core loss. It is recommended that the temperature of the part not exceed 125°C.  
(3) Peak current for approximate 30% roll off at 20°C.

(4) DCR limits @ 20°C.  
(5) Applied Volt-Time product (V-uS) across the inductor at 100KHz necessary to generate a core loss equal to 10% of the total losses for 40°C temperature rise.

Part Number	Rated Inductance (µH)	OCL (1) +/-20% (µH)	Part Marking	I <sub>rms</sub> (2) Amperes	I <sub>sat</sub> (3) Amperes	DCR (4) (Ω) Typ.	Volt u-sec Typ.
SD25-3R3	3.30	3.43	F	2.64	2.21	0.0384	5.78
SD25-4R7	4.70	5.03	G	2.39	1.83	0.0467	6.99
SD25-6R8	6.80	6.93	H	2.19	1.56	0.0556	8.21
SD25-8R2	8.20	7.99	J	1.92	1.45	0.0724	8.82
SD25-100	10.0	10.35	K	1.80	1.27	0.0824	10.03
SD25-150	15.0	14.45	L	1.67	1.08	0.0956	11.86
SD25-220	22.0	22.81	M	1.34	0.857	0.1478	14.90
SD25-330	33.0	33.07	N	1.11	0.711	0.2149	17.94
SD25-470	47.0	47.89	O	0.919	0.592	0.3156	21.58
SD25-680	68.0	68.64	P	0.741	0.482	0.4850	25.84
SD25-820	82.0	82.17	Q	0.713	0.441	0.5242	28.27
SD25-101	100	100.79	R	0.670	0.398	0.5937	31.31
SD25-151	150	148.4	S	0.553	0.328	0.8723	38.00
SD25-221	220	222.4	T	0.446	0.268	1.34	46.51
SD25-331	330	332.2	U	0.359	0.219	2.07	56.85
SD25-471	470	472.4	V	0.293	0.184	3.10	67.79
SD25-681	680	677.2	W	0.262	0.154	3.88	81.17
SD25-821	820	826.7	X	0.230	0.139	5.04	89.68
SD25-102	1000	1003.4	Y	0.216	0.126	5.70	98.80

- (1) Open Circuit Inductance Test Parameters: 100KHz, 0.25Vrms, 0.0Adc.  
 (2) RMS current for an approximate ΔT of 40°C without core loss. It is recommended that the temperature of the part not exceed 125°C.  
 (3) Peak current for approximate 30% roll off at 20°C.

- (4) DCR limits @ 20°C.  
 (5) Applied Volt-Time product (V-uS) across the inductor at 100kHz necessary to generate a core loss equal to 10% of the total losses for 40°C temperature rise.

### Mechanical Diagrams

#### SD Series

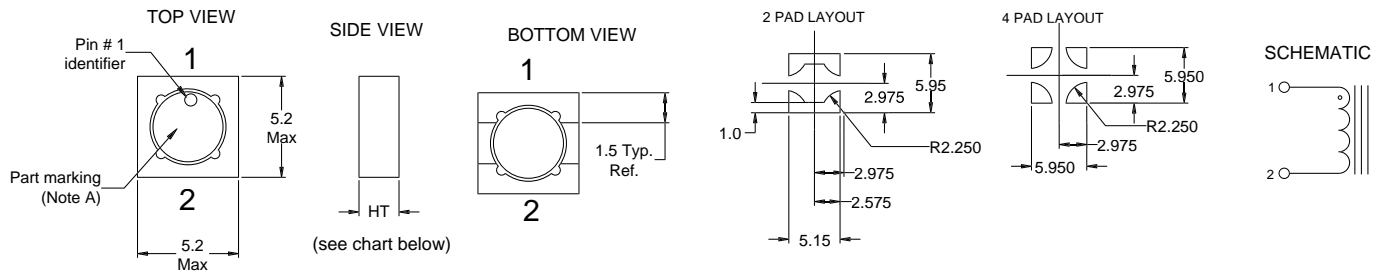

Series	HT
SD10	1.0mm max
SD12	1.2mm max
SD18	1.8mm max
SD20	2.0mm max
SD25	2.5mm max

A) Part Marking: Line 1: (1st digit indicates the inductance value per part marking designator in chart above)  
 (2nd digit is a bi-weekly production date code)  
 (3rd digit is the last digit of the year produced)  
 Line 2: 12 (indicates the product size code)

**Packaging Information**

**SD10 Series**

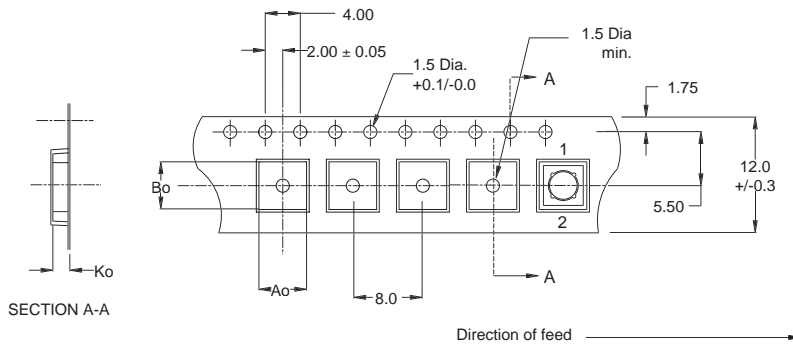

Ao=5.45mm  
 Bo=5.45mm  
 Ko=1.20mm

ACTUAL SIZE  
 SD10

Parts packaged on 13" Diameter reel,  
 3,800 parts per reel.

**SD12/18 Series**

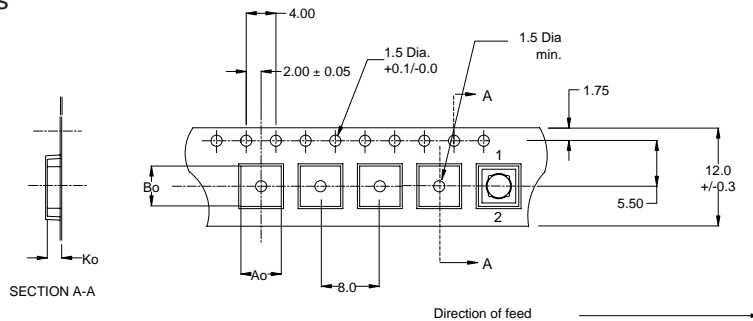

Ao=5.45mm  
 Bo=5.45mm  
 Ko=2.00mm

ACTUAL SIZE  
 SD12

ACTUAL SIZE  
 SD18

Parts packaged on 13" Diameter reel,  
 3,800 parts per reel.

**SD20/25 Series**

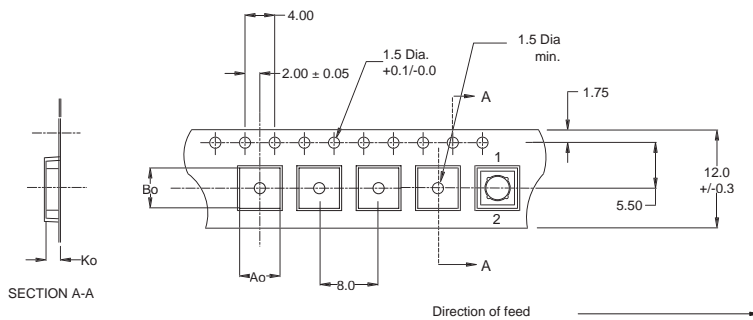

Ao=5.45mm  
 Bo=5.45mm  
 Ko=2.70mm

ACTUAL SIZE  
 SD20

ACTUAL SIZE  
 SD25

Parts packaged on 13" Diameter reel,  
 2,900 parts per reel.

Dimensions are in millimeters.

**DC Current vs. Temperature**

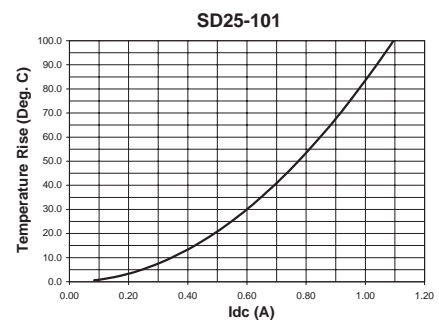
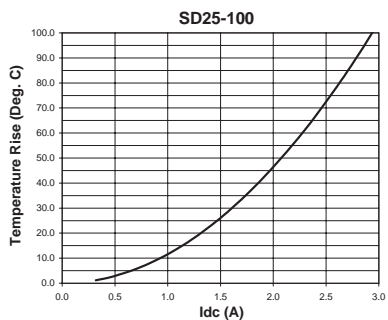
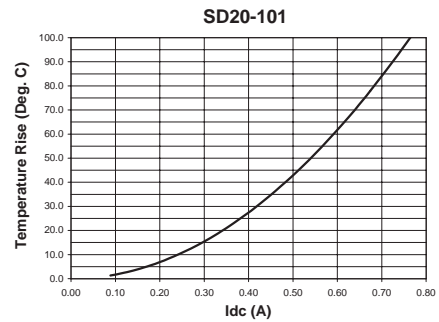
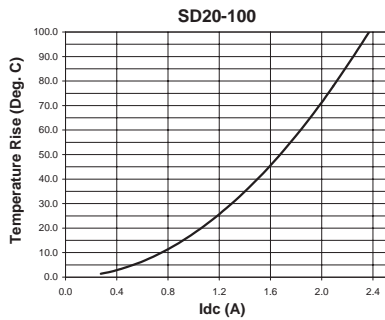
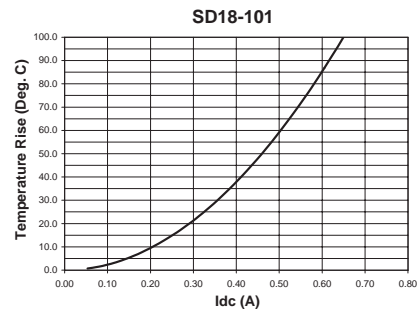
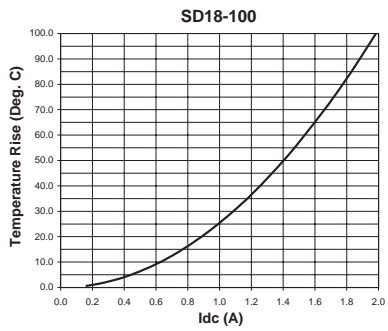
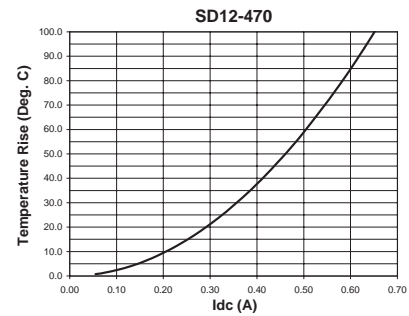
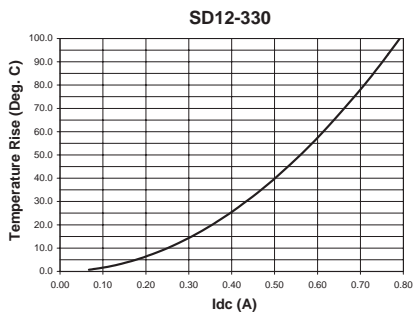
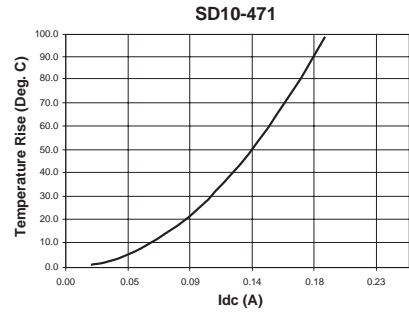
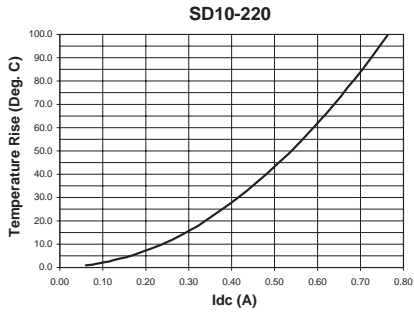

**Rolloff**

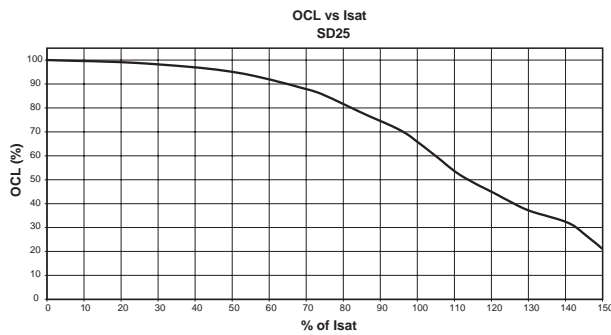
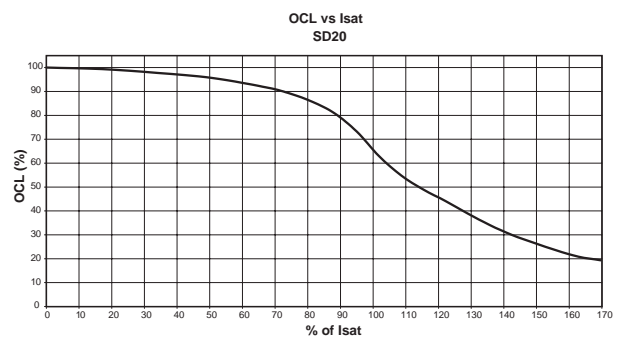
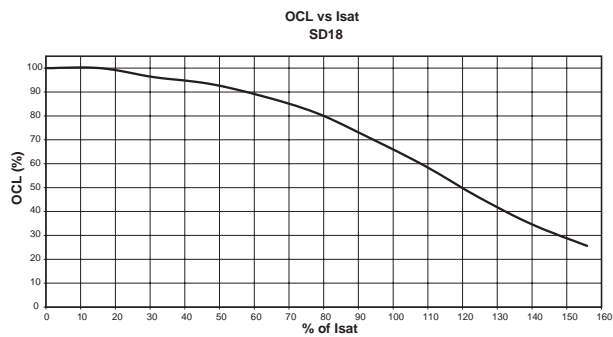
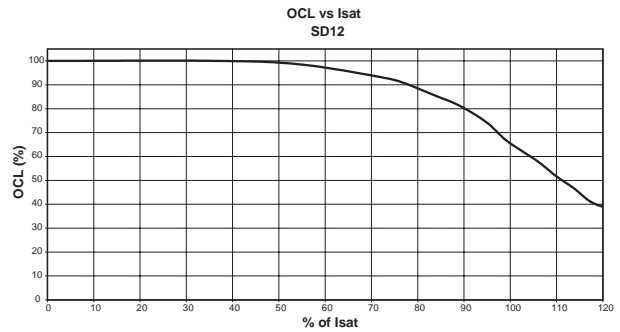
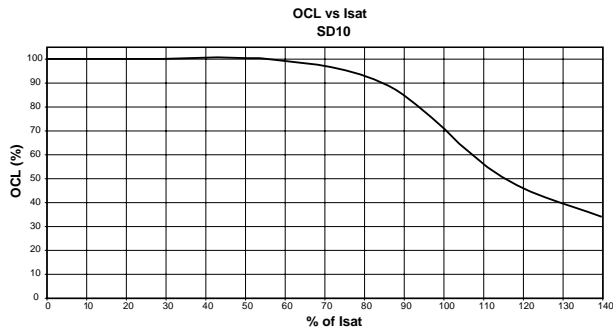

**Core Loss**

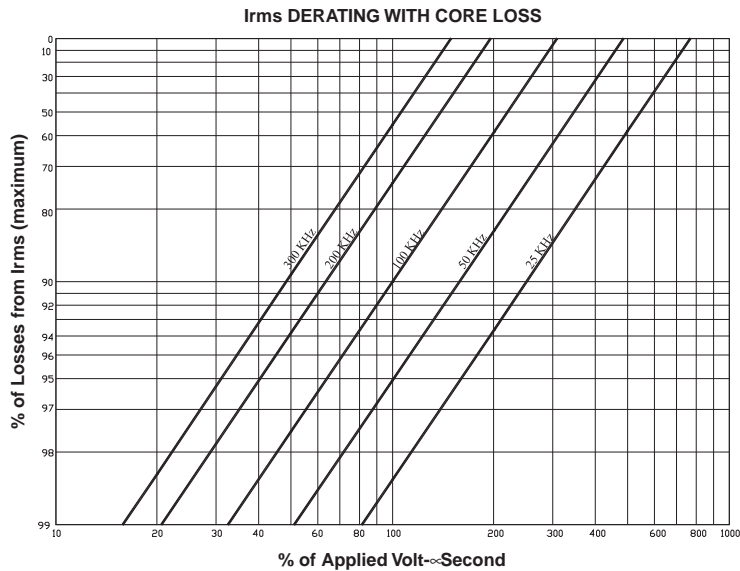

Part Number	Rated Inductance (µH)	OCL (1) +/-20% (µH)	Part Marking	I <sub>rms</sub> (2) Amperes	I <sub>sat</sub> (3) Amperes	DCR (4) (Ω) Typ.	Volt u-sec Typ.
SD52-1R2	1.20	1.20	A	2.33	3.14	0.0279	1.49
SD52-2R2	2.20	2.20	B	1.98	2.30	0.0385	2.03
SD52-3R5	3.50	3.50	C	1.73	1.82	0.0503	2.57
SD52-4R7	4.70	4.70	D	1.63	1.64	0.0568	2.84
SD52-6R8	6.80	6.80	E	1.39	1.28	0.0777	3.65
SD52-100	10.0	10.0	F	1.11	1.11	0.1215	4.19
SD52-150	15.0	15.0	G	0.97	0.88	0.1618	5.27
SD52-220	22.0	22.0	H	0.86	0.73	0.2042	6.35
SD52-270	27.0	27.0	J	0.73	0.65	0.2864	7.16
SD52-330	33.0	33.0	K	0.70	0.61	0.3074	7.70
SD52-470	47.0	47.0	L	0.58	0.50	0.4465	9.32
SD52-680	68.0	68.0	M	0.47	0.42	0.6829	11.21
SD52-101	100	100	N	0.39	0.35	1.0000	13.37

(1) Open Circuit Inductance Test Parameters: 100KHz, 0.25Vrms, 0.0Adc.  
 (2) RMS current for an approximate ΔT of 40°C without core loss. It is recommended that the temperature of the part not exceed 125°C.  
 (3) Peak current for approximate 30% roll off at 20°C.

(4) DCR limits @ 20°C.  
 (5) Applied Volt-Time product (V-uS) across the inductor at 100kHz necessary to generate a core loss equal to 10% of the total losses for 40°C temperature rise.

**Mechanical Diagrams**

**SD52 Series**

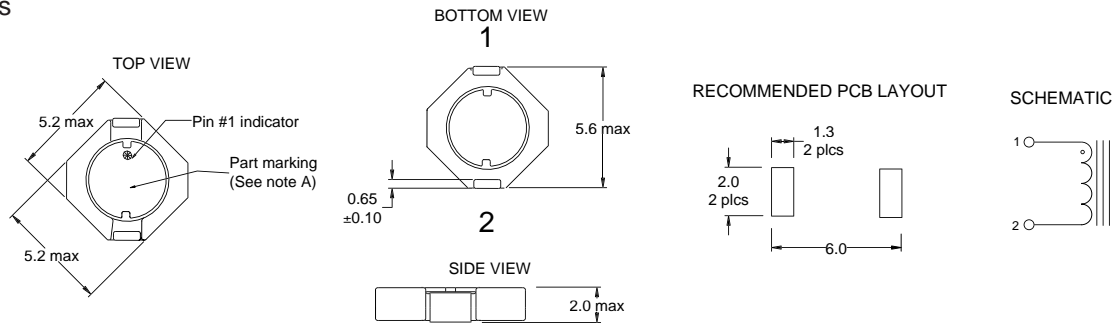

A) Part Marking: Line 1: (1st digit indicates the inductance value per part marking designator in chart above)  
 (2nd digit is a bi-weekly production date code)  
 (3rd digit is the last digit of the year produced)  
 Line 2: 12 (indicates the product size code)

**Packaging Information**

**SD52 Series**

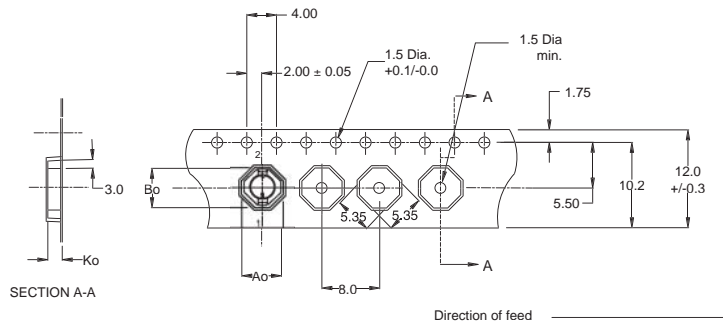

A<sub>0</sub>=5.72mm  
 B<sub>0</sub>=5.72mm  
 K<sub>0</sub>=2.30mm

**ACTUAL SIZE**  
**SD52**

Parts packaged on 13" Diameter reel,  
 3,500 parts per reel.

Dimensions are in millimeters.

**DC Current vs. Temperature**

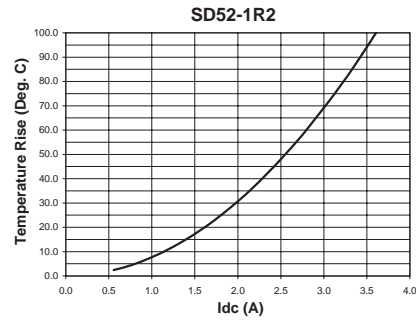
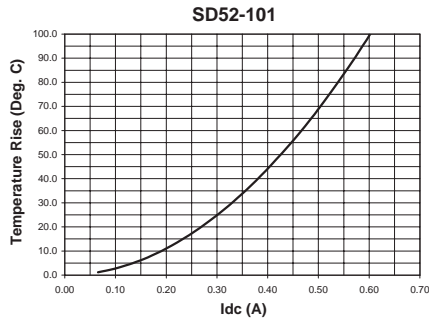

**Rolloff**

