

LIGHT EMITTING DIODE SE307-C

GaAs INFRARED EMITTING DIODE

DESCRIPTION

The SE307-C is a GaAs (Gallium Arsenide) Infrared Emitting Diode which is mounted on the lead frames and molded in plastic. On forward bias, it emits a spectrally narrow band of radiation peaking at 940 nm.

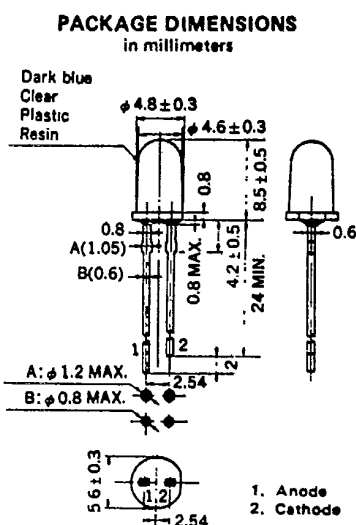

FEATURES

- Economical.
- High output power.
- Long Life.
- Good linearity.
- Spectrally matched to silicon sensors.
- Long lead.

APPLICATIONS

- Paper Tape and Punch Card Readers.
- Light source for smoke detector.
- Optical encoders.
- Photochoppers, Isolator.
- Light source for remote control.

ABSOLUTE MAXIMUM RATINGS

Maximum Power Dissipation ($T_a = 25^\circ\text{C}$)	P	150	mW
Maximum Forward Current ($T_a = 25^\circ\text{C}$)	I_F	100	mA
Maximum Pulse Forward Current ($T_a = 25^\circ\text{C}$)	I_{FP}^*	1.0	A
Maximum Reverse Voltage ($T_a = 25^\circ\text{C}$)	V_R	5.0	V
Maximum Temperatures			
Junction Temperature	T_j	+100	$^\circ\text{C}$
Storage Temperature	T_{stg}	-40 to +100	$^\circ\text{C}$
Operating Temperature	T_{opt}	-30 to +85	$^\circ\text{C}$

ELECTRO-OPTICAL CHARACTERISTICS ($T_a = 25^\circ\text{C}$)

CHARACTERISTIC	SYMBOL	MIN.	TYP.	MAX.	UNIT	TEST CONDITIONS
Forward Voltage	V_F		1.25	1.4	V	$I_F = 50\text{ mA}$
Pulse Forward Voltage	V_{FP}^*		2.1	2.6	V	$I_{FP} = 1.0\text{ A}$
Capacitance	C_t		40		pF	$V = 0, f = 1.0\text{ MHz}$
Peak Emission Wavelength	λ_{peak}		940		nm	$I_F = 50\text{ mA}$
Spectral Line Half Width	$J\lambda$		50		nm	$I_F = 50\text{ mA}$
Output Power	I_e	20	30		mW/sr	$I_F = 50\text{ mA}$
Light Turn-On and Turn-Off	t_{on}, t_{off}		1		μs	

* $f = 1.0\text{ kHz}$, Duty Cycle 1 %

T-41-11

TYPICAL CHARACTERISTICS ($T_a = 25^\circ\text{C}$)

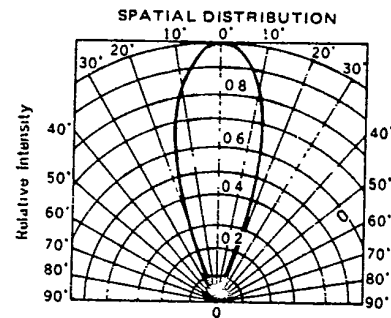
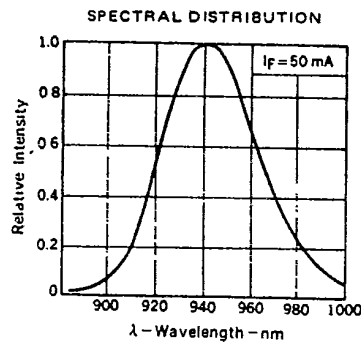
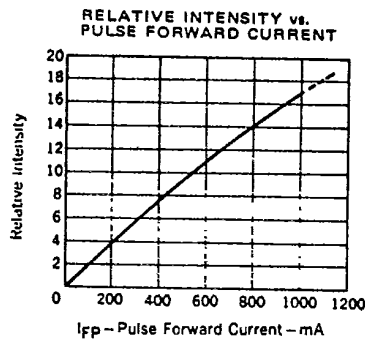
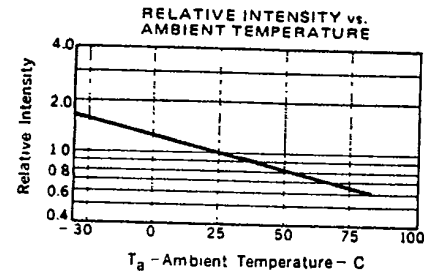
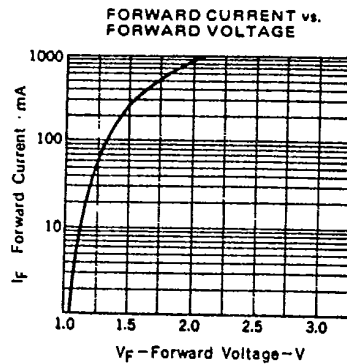
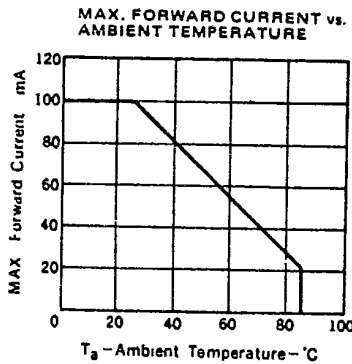

HANDLING PRECAUTIONS:

1. The full resin-molded LED lamps have generally a little mechanical and thermal strength than other resin-molded semiconductor devices as they have less additives. Therefore please note on the following points.
 - (a) Soldering of leads should be made at the point 5 mm or more from the root of the leads at 260°C and within 5 s.
 - (b) If the temperature of the molded portion rises in addition to the residual stress between the leads, the possibility that open or short circuit occurs due to the deformation or destruction of the resin will increase.
2. On cleaning the device:
 - (a) Cleaning with unsuitable solvent may impair the resin of the package and the following solvents should be used at the temperature of less than 45°C and for less than 3 minutes of immersion time.
 - Ethanol, Methanol
 - Isopropyl-alcohol
 - (b) Ultrasonic cleaning will add some stress on devices. The degree of the stress differs depending on the oscillation output power, the size of the PCB and the mounting methods of the devices, therefore it should be confirmed by making an experiment at actual conditions that the cleaning does not have any problem on the devices.

2