

SEMiX 253GB176HD

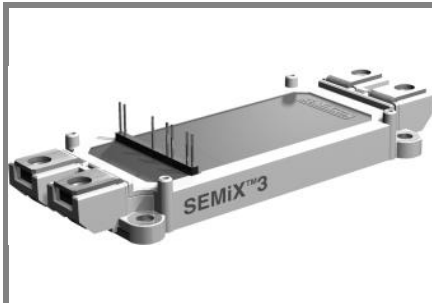

SEMiX® 3

Trench IGBT Modules

SEMiX 253GB176HD

Preliminary Data

Features

- Homogeneous Si
- Trench = Trenchgate technology
- $V_{CE(sat)}$ with positive temperature coefficient
- High short circuit capability

Typical Applications

- AC inverter drives
- UPS
- Electronic welders

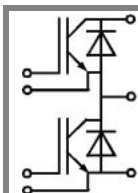

GB

Absolute Maximum Ratings		$T_c = 25^\circ\text{C}$, unless otherwise specified	
Symbol	Conditions	Values	Units
IGBT			
V_{CES}		1700	V
I_C	$T_c = 25 (80)^\circ\text{C}$	250 (180)	A
I_{CRM}	$t_p = 1 \text{ ms}$	300	A
V_{GES}		± 20	V
T_{vj} (T_{stg})	$T_{OPERATION} \leq T_{stg}$	- 40 ... + 150 (125)	$^\circ\text{C}$
V_{isol}	AC, 1 min.	4000	V
Inverse diode			
I_F	$T_c = 25 (80)^\circ\text{C}$	240 (170)	A
I_{FRM}	$t_p = 1 \text{ ms}$	300	A
I_{FSM}	$t_p = 10 \text{ ms}; \text{sin.}; T_j = 25^\circ\text{C}$	1500	A

Characteristics		$T_c = 25^\circ\text{C}$, unless otherwise specified			
Symbol	Conditions	min.	typ.	max.	Units
IGBT					
$V_{GE(th)}$	$V_{GE} = V_{CE}, I_C = 6 \text{ mA}$	5,2	5,8	6,4	V
I_{CES}	$V_{GE} = 0, V_{CE} = V_{CES}, T_j = 25 (125)^\circ\text{C}$			1	mA
$V_{CE(TO)}$	$T_j = 25 (125)^\circ\text{C}$		1 (0,9)	1,2 (1,1)	V
r_{CE}	$V_{GE} = 15 \text{ V}, T_j = 25 (125)^\circ\text{C}$		6,7 (10,3)	8,3 (12)	m Ω
$V_{CE(sat)}$	$I_{Cnom} = 150 \text{ A}, V_{GE} = 15 \text{ V}, T_j = 25 (125)^\circ\text{C}$, chip level		2 (2,45)	2,45 (2,9)	V
C_{ies}	under following conditions		12		nF
C_{oes}	$V_{GE} = 0, V_{CE} = 25 \text{ V}, f = 1 \text{ MHz}$		0,5		nF
C_{res}			0,4		nF
L_{CE}			20		nH
$R_{CC'+EE'}$	terminal-chip, $T_c = 25 (125)^\circ\text{C}$		0,7 (1)		m Ω
$t_{d(on)}/t_r$	$V_{CC} = 1200 \text{ V}, I_{Cnom} = 150 \text{ A}$		190 / 45		ns
$t_{d(off)}/t_f$	$V_{GE} = \pm 15 \text{ V}$		830 / 130		ns
$E_{on} (E_{off})$	$R_{Gon} = R_{Goff} = 9,2 \Omega, T_j = 125^\circ\text{C}$		95 (55)		mJ
Inverse diode					
$V_F = V_{EC}$	$I_{Fnom} = 150 \text{ A}; V_{GE} = 0 \text{ V}; T_j = 25 (125)^\circ\text{C}$, chip level		1,7 (1,7)	1,9 (1,9)	V
$V_{(TO)}$	$T_j = 25 (125)^\circ\text{C}$		1,1 (0,9)	1,3 (1,1)	V
r_T	$T_j = 25 (125)^\circ\text{C}$		4 (5,3)	4 (5,3)	m Ω
I_{RRM}	$I_{Fnom} = 150 \text{ A}; T_j = 25 (125)^\circ\text{C}$		(230)		A
Q_{rr}	$di/dt = 3400 \text{ A}/\mu\text{s}$		(58)		μC
E_{rr}	$V_{GE} = -15 \text{ V}$		(35)		mJ
Thermal characteristics					
$R_{th(j-c)}$	per IGBT			0,12	K/W
$R_{th(j-c)D}$	per Inverse Diode			0,17	K/W
$R_{th(j-c)FD}$	per FWD				K/W
$R_{th(c-s)}$	per module		0,04		K/W
Temperature sensor					
R_{25}	$T_c = 25^\circ\text{C}$		5 \pm 5%		k Ω
$B_{25/85}$	$R_2 = R_1 \exp[B(1/T_2 - 1/T_1)]; T[K]; B$		3420		K
Mechanical data					
M_s/M_t	to heatsink (M5) / for terminals (M6)	3/2,5		5 / 5	Nm
w			289		g

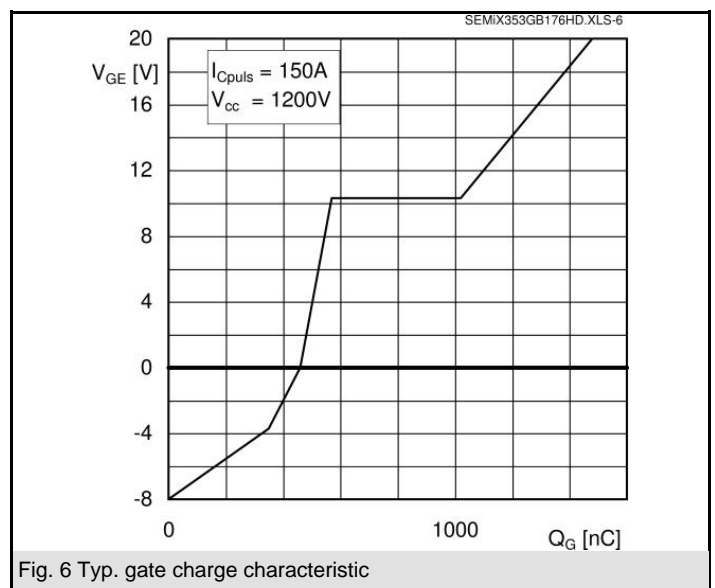
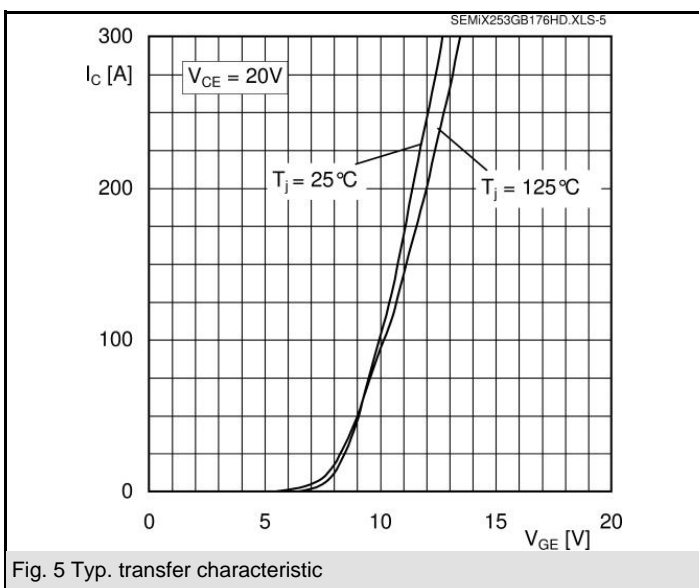
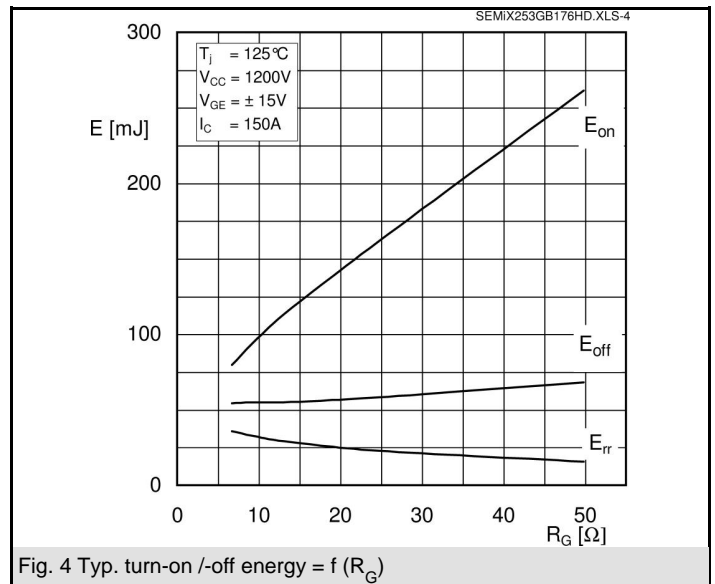
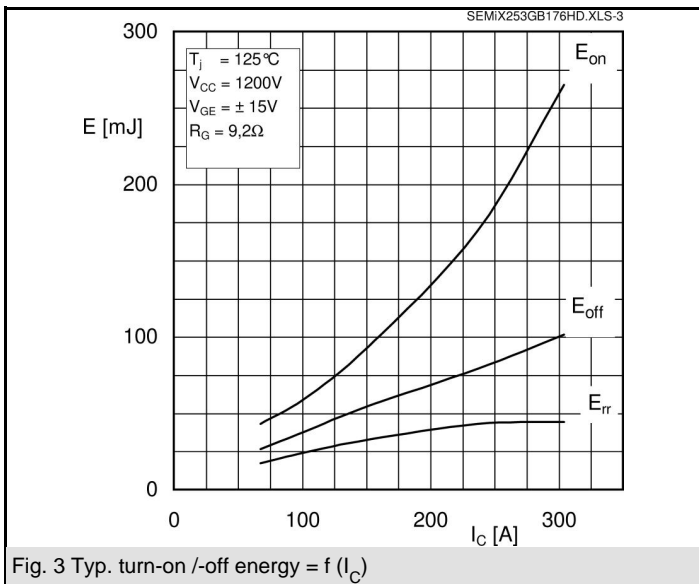
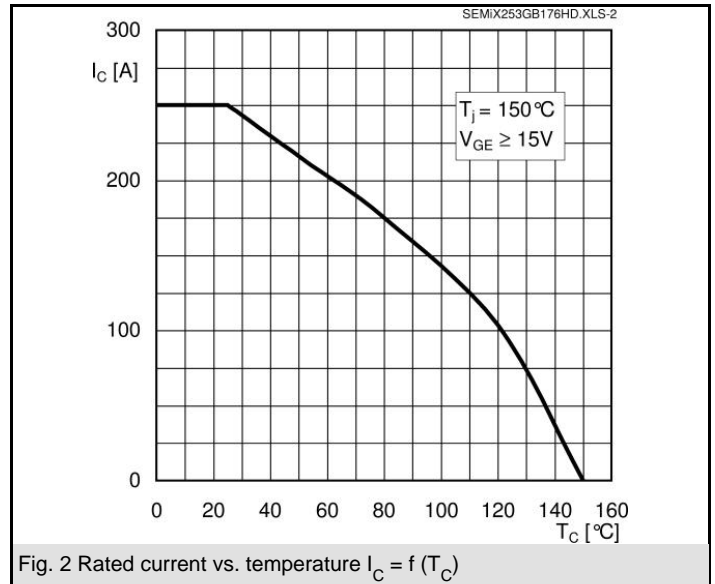
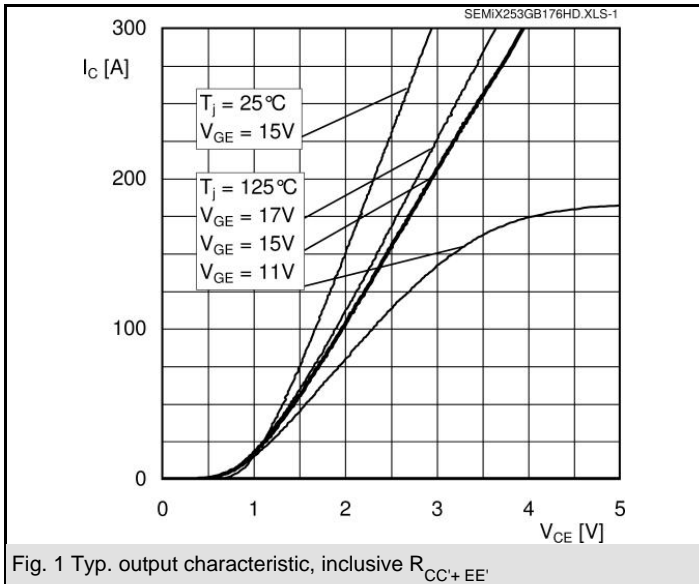

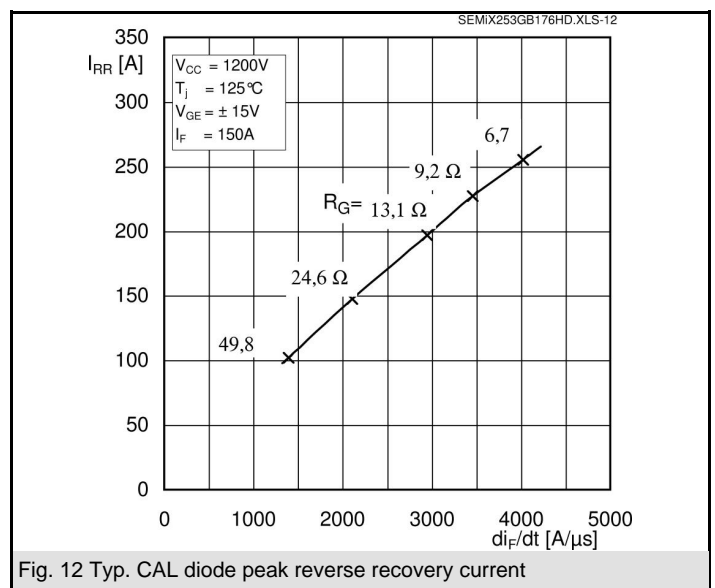
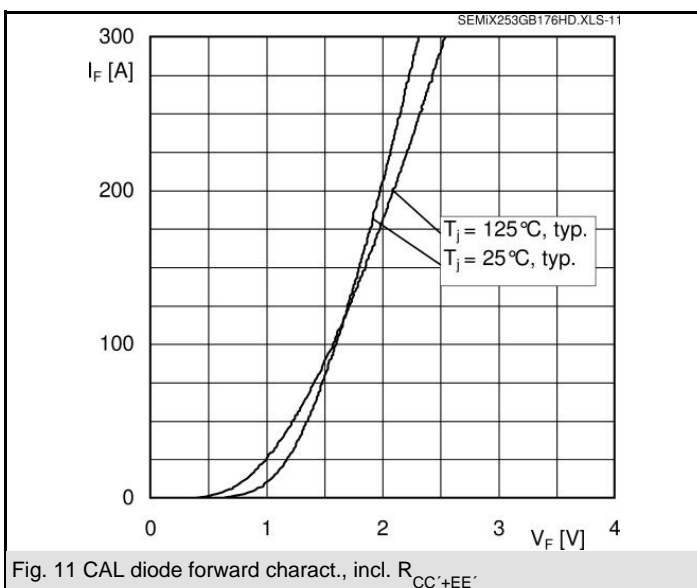
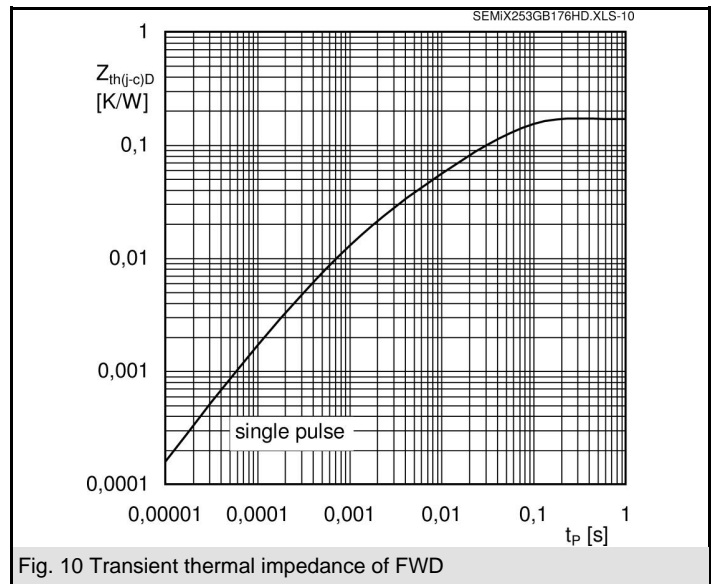
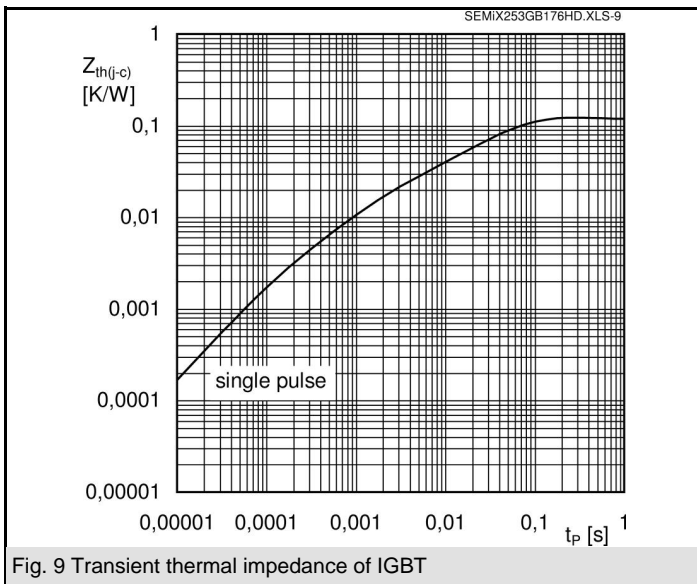
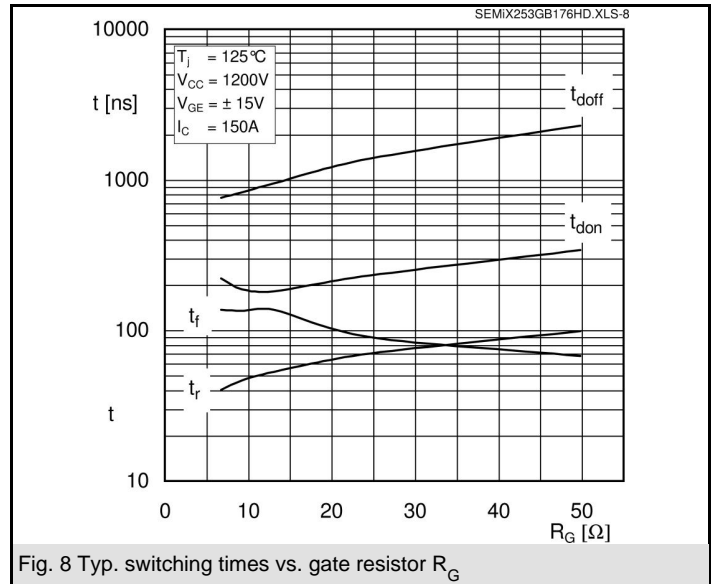
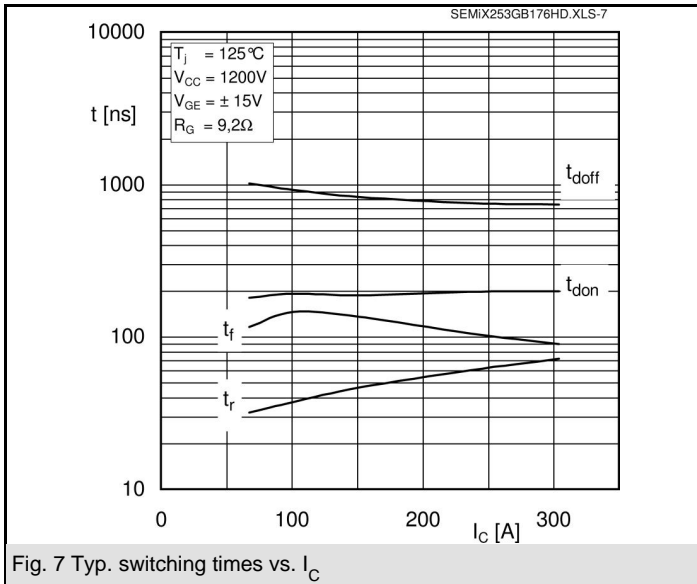

SEMiX 253GB176HD

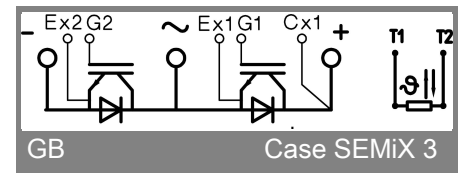
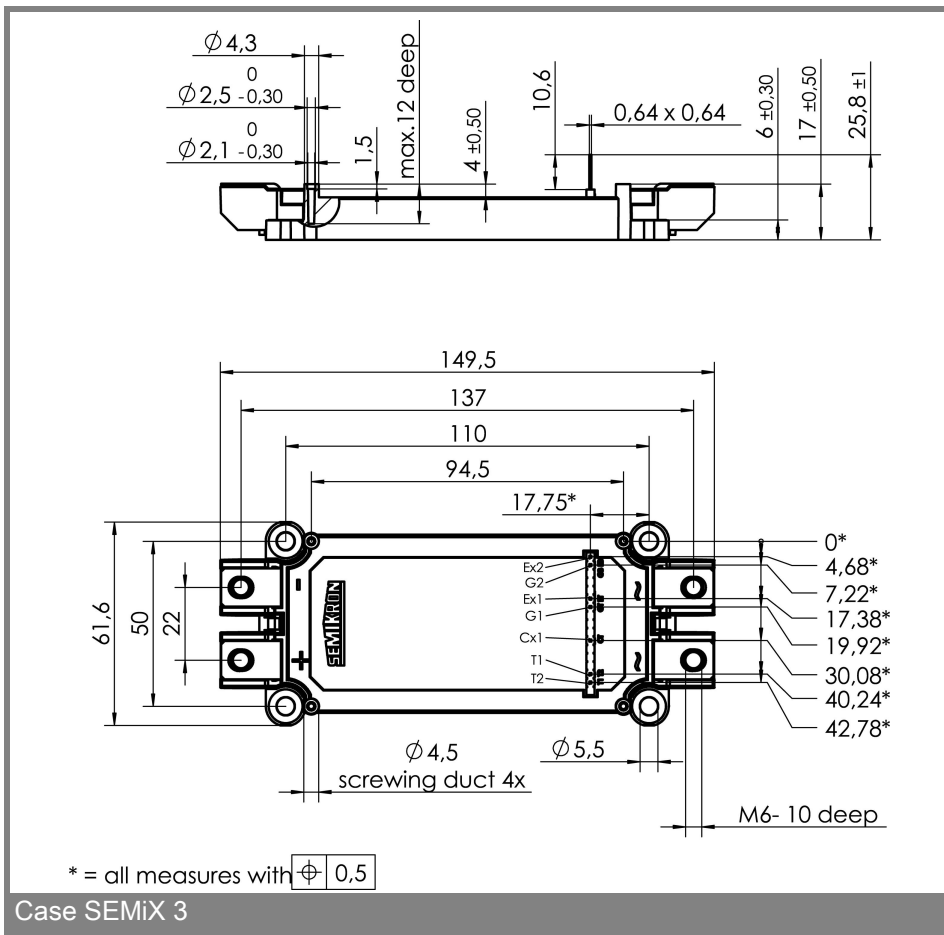
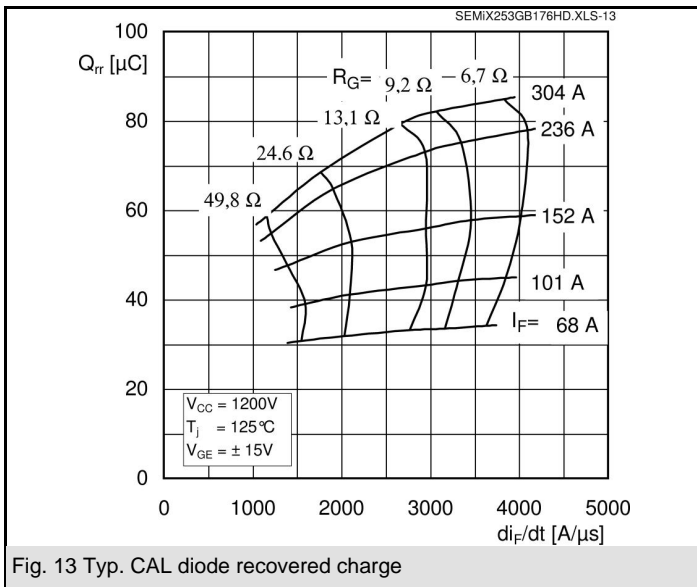

This is an electrostatic discharge sensitive device (ESDS), international standard IEC 60747-1, Chapter IX.

This technical information specifies semiconductor devices but promises no characteristics. No warranty or guarantee expressed or implied is made regarding delivery, performance or suitability.