

SEMiX 302GB126HD ...

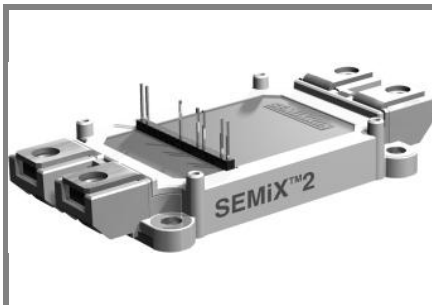

SEMiX® 2

Trench IGBT Modules

SEMiX 302GB126HD

SEMiX 302GAL126HD

SEMiX 302GAR126HD

Target Data

Features

- Homogeneous Si
- Trench = Trenchgate technology
- $V_{CE(sat)}$ with positive temperature coefficient
- High short circuit capability

Typical Applications

- AC inverter drives
- UPS
- Electronic welders

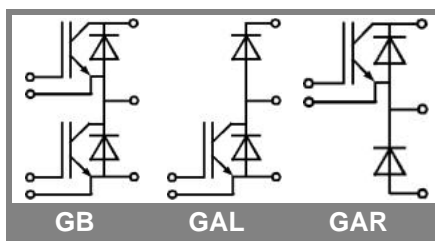

Absolute Maximum Ratings		$T_{case} = 25^{\circ}C$, unless otherwise specified	
Symbol	Conditions	Values	Units
IGBT			
V_{CES}		1200	V
I_C	$T_c = 25 (80) ^{\circ}C$	300 (210)	A
I_{CRM}	$t_p = 1 \text{ ms}$	400	A
V_{GES}		± 20	V
T_{vj} (T_{stg})	$T_{OPERATION} \leq T_{stg}$	- 40 ... + 150 (125)	$^{\circ}C$
V_{isol}	AC, 1 min.	4000	V
Inverse diode			
I_F	$T_c = 25 (80) ^{\circ}C$	250 (170)	A
I_{FRM}	$t_p = 1 \text{ ms}$	400	A
I_{FSM}	$t_p = 10 \text{ ms}; \text{sin.}; T_j = 25 ^{\circ}C$	1300	A

Characteristics		$T_{case} = 25^{\circ}C$, unless otherwise specified			
Symbol	Conditions	min.	typ.	max.	Units
IGBT					
$V_{GE(th)}$	$V_{GE} = V_{CE}, I_C = 8 \text{ mA}$	5	5,8	6,5	V
I_{CES}	$V_{GE} = 0, V_{CE} = V_{CES}, T_j = 25 (125) ^{\circ}C$			1,3	mA
$V_{CE(TO)}$	$T_j = 25 (125) ^{\circ}C$	1 (0,9)		1,2 (1,1)	V
r_{CE}	$V_{GE} = 15 \text{ V}, T_j = 25 (125) ^{\circ}C$	3,5 (5,5)		4,8 (6,8)	m Ω
$V_{CE(sat)}$	$I_{Cnom} = 200 \text{ A}, V_{GE} = 15 \text{ V}, T_j = 25 (125) ^{\circ}C$, chip level	1,7 (2)		2,15 (2,45)	V
C_{ies}	under following conditions		14,4		nF
C_{oes}	$V_{GE} = 0, V_{CE} = 25 \text{ V}, f = 1 \text{ MHz}$		0,8		nF
C_{res}			0,7		nF
L_{CE}			18		nH
$R_{CC'+EE'}$	terminal-chip, $T_c = 25 (125) ^{\circ}C$				m Ω
$t_{d(on)}/t_r$	$V_{CC} = 600 \text{ V}, I_{Cnom} = 200 \text{ A}$		320 / 50		ns
$t_{d(off)}/t_f$	$V_{GE} = \pm 15 \text{ V}$		600 / 100		ns
$E_{on} (E_{off})$	$R_{Gon} = R_{Goff} = 2,8 \Omega, T_j = 125 ^{\circ}C$		30 (26)		mJ
Inverse diode					
$V_F = V_{EC}$	$I_{Fnom} = 200 \text{ A}; V_{GE} = 0 \text{ V}; T_j = 25 (125) ^{\circ}C$, chip level	1,6 (1,6)		1,8 (1,8)	V
$V_{(TO)}$	$T_j = 25 (125) ^{\circ}C$	1 (0,8)		1,1 (0,9)	V
r_T	$T_j = 25 (125) ^{\circ}C$	3 (4)		3,5 (4,5)	m Ω
I_{RRM}	$I_{Fnom} = 200 \text{ A}; T_j = 25 (125) ^{\circ}C$	(290)			A
Q_{rr}	$di/dt = 5900 \text{ A}/\mu\text{s}$	(55)			μC
E_{rr}	$V_{GE} = -15 \text{ V}$	(22)			mJ
Thermal characteristics					
$R_{th(j-c)}$	per IGBT			0,125	K/W
$R_{th(j-c)D}$	per Inverse Diode			0,25	K/W
$R_{th(j-c)FD}$	per FWD				K/W
$R_{th(c-s)}$	per module		0,045		K/W
Temperature sensor					
R_{25}	$T_c = 25 ^{\circ}C$		5 \pm 5%		k Ω
$B_{25/85}$	$R_2 = R_1 \exp[B(1/T_2 - 1/T_1)]; T[K]; B$		3420		K
Mechanical data					
M_s/M_t	to heatsink (M5) / for terminals (M6)	3/2,5		5 / 5	Nm
w			250		g

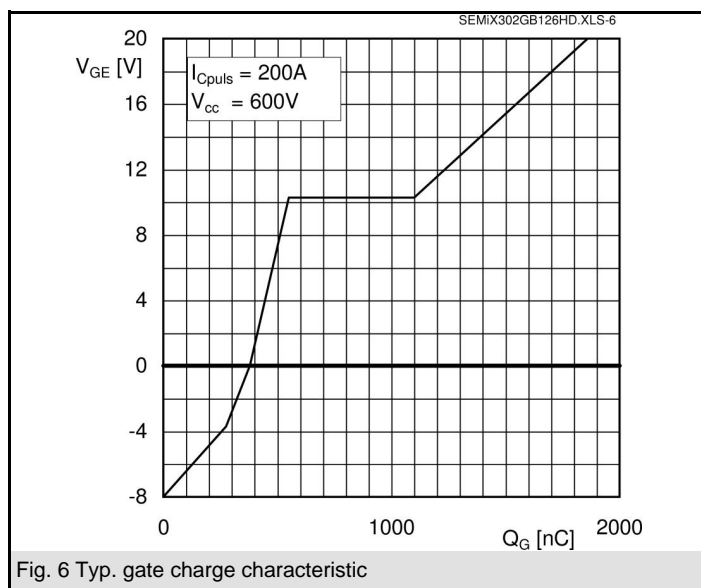
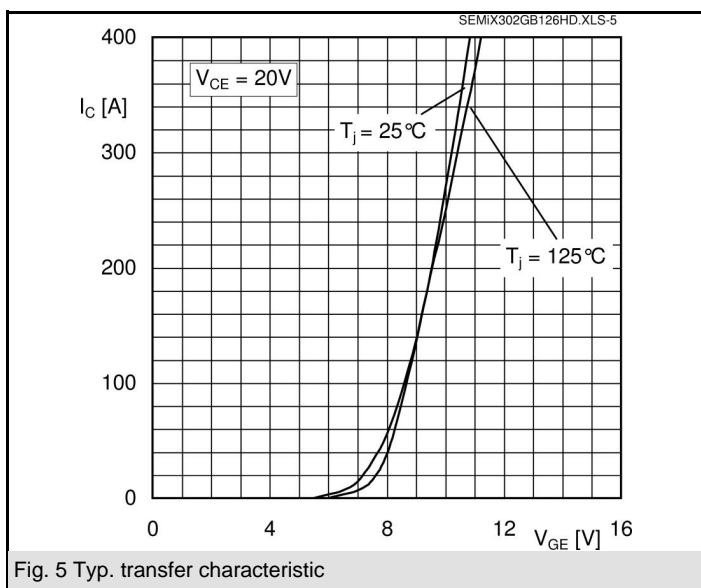
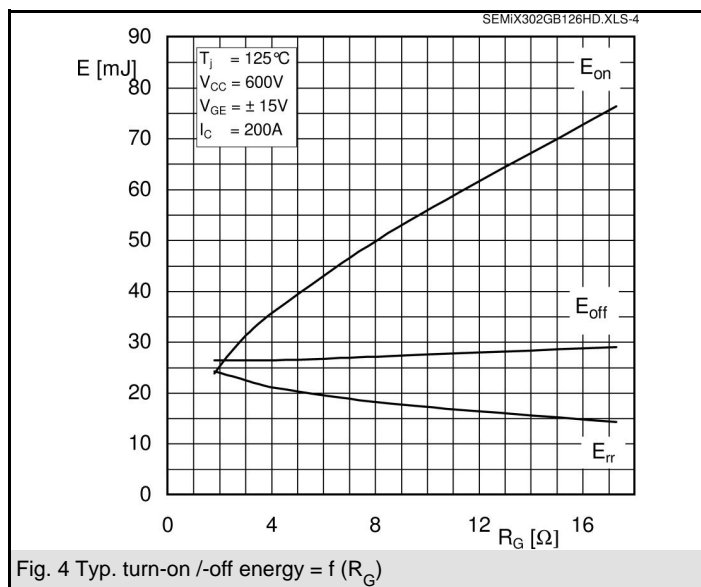
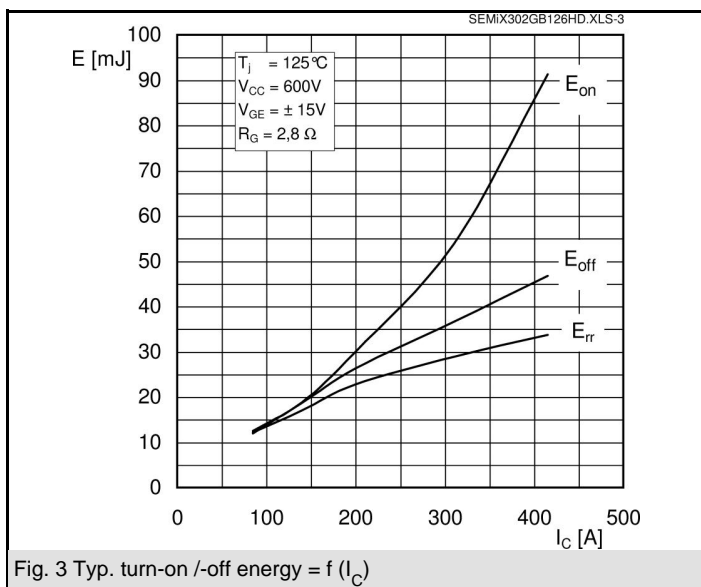
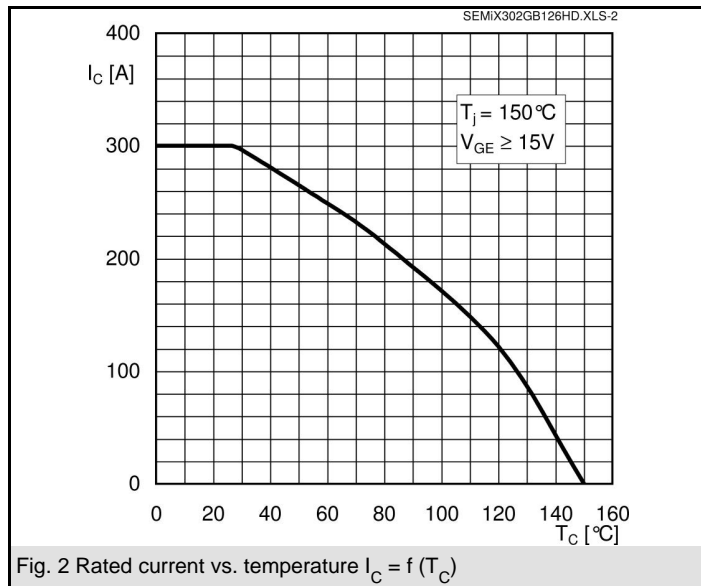
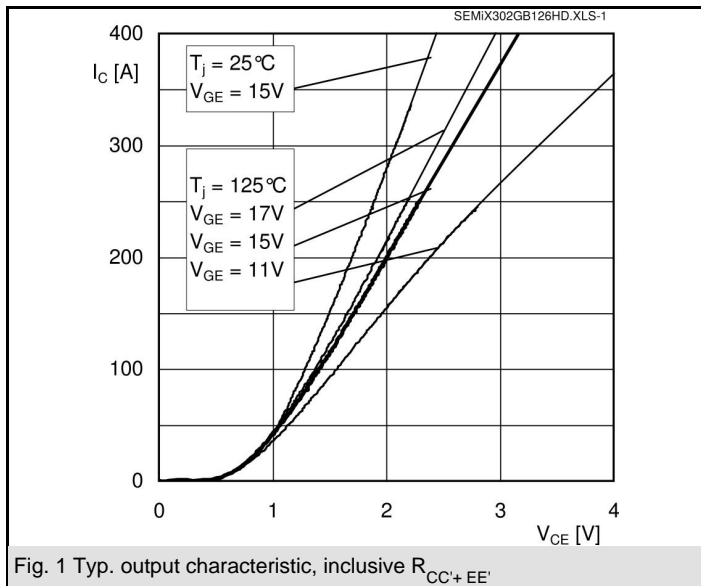

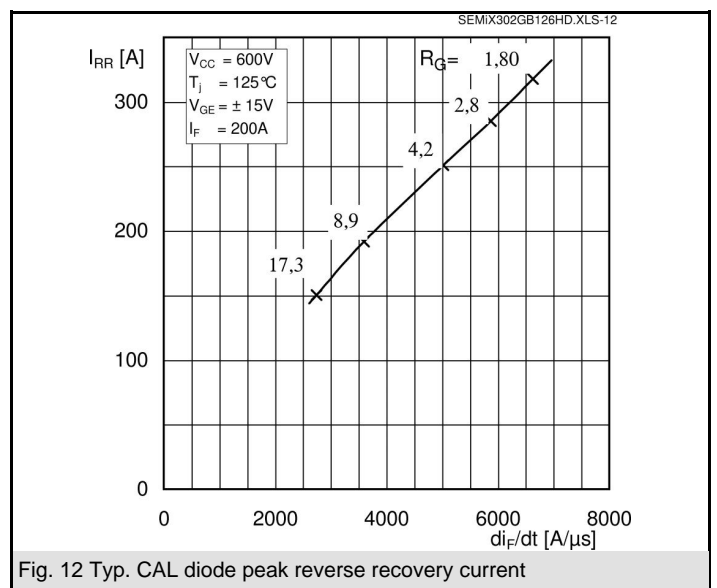
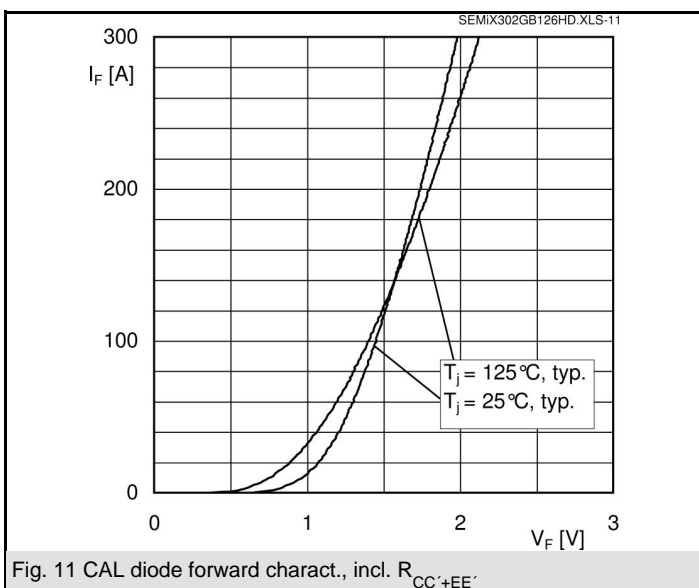
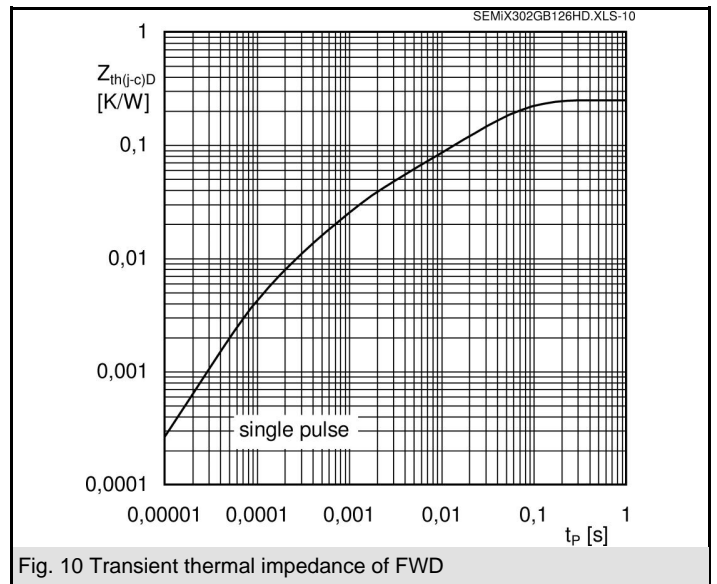
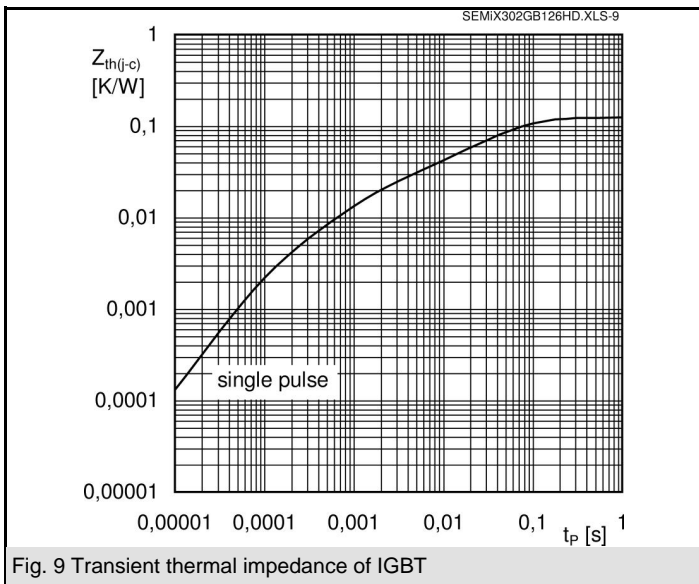
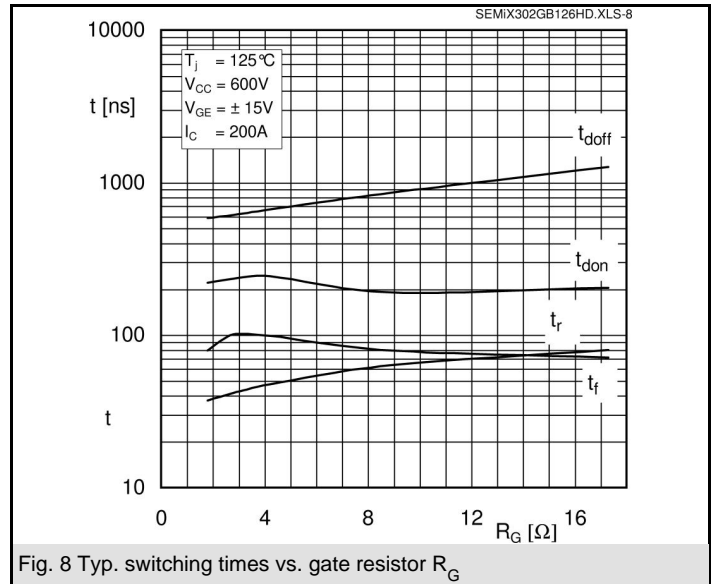
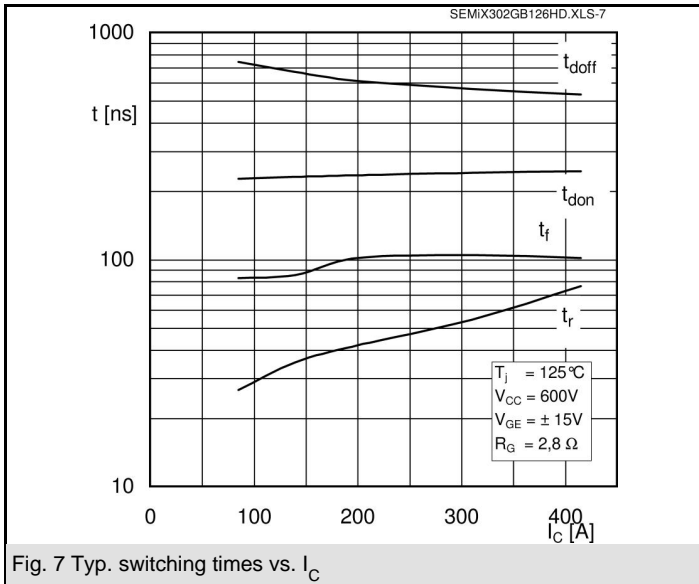

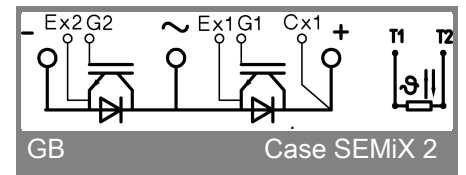
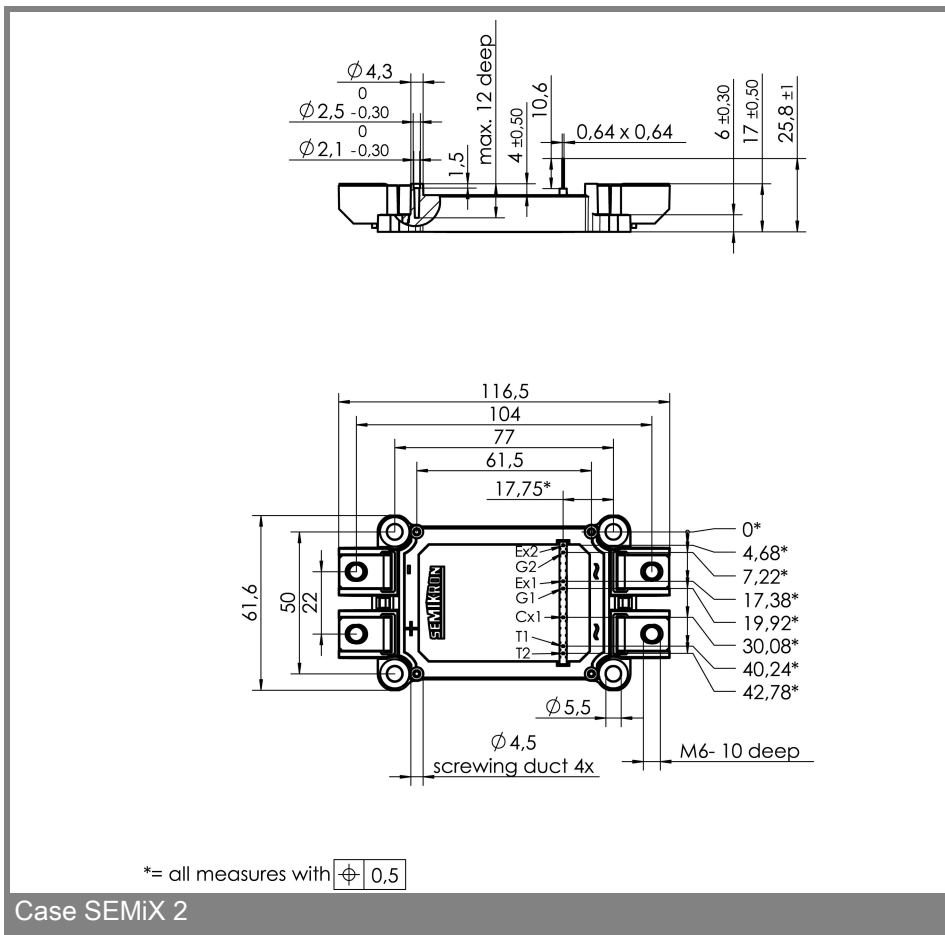
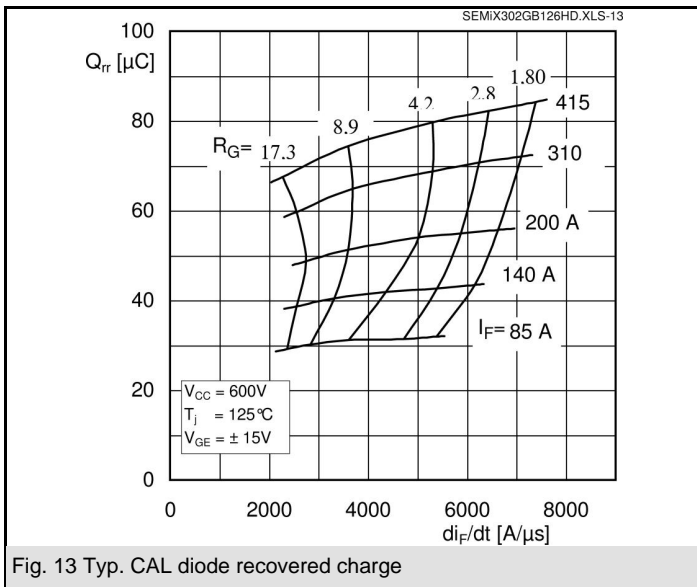

This is an electrostatic discharge sensitive device (ESDS), international standard IEC 60747-1, Chapter IX.

This technical information specifies semiconductor devices but promises no characteristics. No warranty or guarantee expressed or implied is made regarding delivery, performance or suitability.