

SIEMENS

SFH600 SERIES

**PHOTOTRANSISTOR
OPTOCOUPLER**

T-41-83

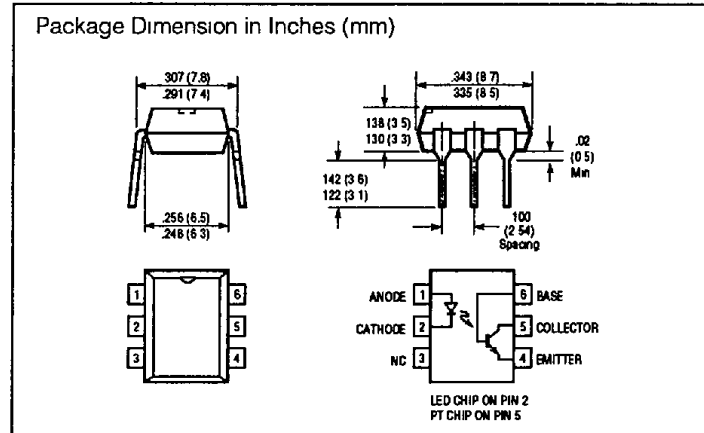
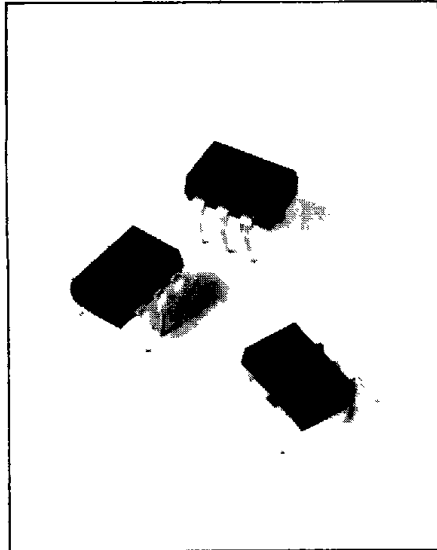

FEATURES

- High Quality Premium Device
- Long Term Stability
- High Current Transfer Ratio, 4 Groups
 - SFH 600-0, 40 to 80%
 - SFH 600-1, 63 to 125%
 - SFH 600-2, 100 to 200%
 - SFH 600-3, 160 to 320%
- 5300 Volt Isolation (1 Minute)
- Storage Temperature -55 to +150° C
- VCE SAT 0.25 (< 0.4) Volt
 $I_F = 10 \text{ mA}, I_C = 2.5 \text{ mA}$
- UL Approval #E52744
- VDE Approval #0883
- VDE Approval #0884 (Optional with Option 1, add -X001 suffix)

DESCRIPTION

The optoelectronic coupler SFH 600 comprises a GaAs LED as the emitter which is optically coupled with a silicon planar phototransistor as the detector. The component is located in a plastic plug-in case 20 AB DIN 41866.

The coupler allows to transfer signals between two electrically isolated circuits. The potential difference between the circuits to be coupled is not allowed to exceed the maximum permissible insulating voltage.

Maximum Ratings

Reverse Voltage (V_R)	6 V
Forward Current (I_F)	60 mA
Surge Current (I_{FS}), $t_D = 10 \mu s$	2.5 A
Power Dissipation (P_{TOT})	100 mW

Detector (Silicon Phototransistor)

Collector-Emitter Voltage (V_{CEQ})	70 V
Emitter-Base Reverse Voltage (V_{EBO})	7 V
Collector Current (I_C)	50 mA
Collector Current (I_{CS}), $t = 1 \text{ ms}$	100 mA
Power Dissipation (P_{TOT})	150 mW

Coupler

Storage Temperature (T_{stor})	-55 to +150° C
Ambient Temperature (T_{amb})	-55 to +100° C
Junction Temperature (T_J)	100° C
Soldering Temperature (T_L), 1 Min	260° C
Isolation Test Voltage (1 Min) (V_{IS}) (between emitter and detector referred to standard climate 23/50 DIN 50014)	5300 V
Tracking Resistance	Min 8.2 mm
Air Path	Min. 7.3 mm

Tracking Resistance

Group III (KC = > 600) in accordance with VDE0110 § 6 Table 3 and DIN 53480/VDE0303, Part 1
 As to nominal isolation voltage VDE 0883 applies

Isolation Resistance (R_{IS}) at $V_{IS} = 500 \text{ V}$	$10^{11} \Omega$
---	------------------

Climatic Conditions

DIN 40040, Humidity Class F

Flammability

DIN57471 or VDE0471, Part 2, of April 1975 or MIL 202E, Method 11A

Characteristics ($T_{amb} = 25^\circ \text{C}$)

Emitter (GaAs LED)

Forward Voltage (V_F) $I_F = 60 \text{ mA}$	1.25 (≤ 1.65) V
Breakdown Voltage (V_{BR}) $I_R = 100 \mu A$	30 (≥ 6) V
Reverse Current (I_R), $V_R = 3 \text{ V}$	0.01 (≤ 10) μA
Capacitance (C_C) $V_R = 0 \text{ V}$ $f = 1 \text{ MHz}$	40 pF
Thermal Resistance ($R_{Th \text{ Jamb}}$)	750 K/W

Detector (Silicon Phototransistor)

Capacitance ($V_{CE} = 5 \text{ V}$ $f = 1 \text{ MHz}$)	
C_{CE}	5.2 pF
C_{CB}	6.5 pF
C_{EB}	9.5 pF
Thermal Resistance ($R_{Th \text{ Jamb}}$)	500 K/W

Coupler

Collector Emitter Saturation Voltage ($V_{CE \text{ sat}}$)	
$I_F = 10 \text{ mA}$ $I_C = 2.5 \text{ mA}$	0.25 (≤ 0.4) V
Coupling Capacitance (C_K)	0.55 pF

The optocouplers are grouped according to their current transfer ratio I_C/I_F at $V_{CE}=5\text{ V}$, marked by dash numbers.

	-0	-1	-2	-3	
I_C/I_F ($I_F=10\text{ mA}$)	40-80	63-125	100-200	160-320	%
I_C/I_F ($I_F=1\text{ mA}$)	30(>13)	45(>22)	70(>34)	90(>56)	%
Collector-Emitter Leakage Current ($V_{CE}=10\text{ V}$) (I_{CEO})	2 (≤ 35)	2 (≤ 35)	5 (≤ 35)	5 (≤ 70)	nA

Linear Operation (without saturation)

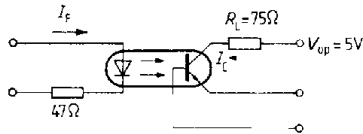

$I_F=10\text{ mA}$, $V_{OP}=5\text{ V}$, $T_{amb}=25^\circ\text{C}$

Load Resistance	R_L	75	Ω
Turn-On Time	t_{ON}	3.2 (≤ 4.6)	μs
Rise Time	t_r	2.0 (≤ 3.0)	μs
Turn-Off Time	t_{OFF}	3.0 (≤ 4.0)	μs
Fall Time	t_f	2.5 (≤ 3.3)	μs
Cut-Off Frequency	F_{CO}	250	KHz

Switching Operation (with saturation)

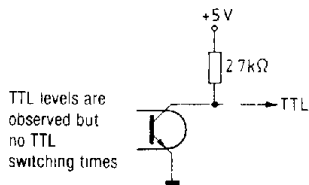
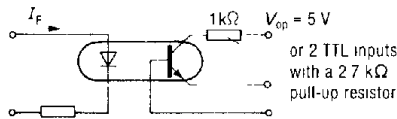

Group	-0 ($I_F=20\text{ mA}$)	-1 and -2 ($I_F=10\text{ mA}$)	-3 ($I_F=5\text{ mA}$)	
Turn-On Time t_{ON}	3.7 (≤ 5.8)	4.5 (≤ 6.2)	5.8 (≤ 8.0)	μs
Rise Time t_r	2.5 (≤ 4.0)	3.0 (≤ 4.2)	4.0 (≤ 5.5)	μs
Turn-Off Time t_{OFF}	19 (≤ 25)	21 (≤ 27)	24 (≤ 31)	μs
Fall Time t_f	11 (≤ 14)	12 (≤ 15)	14 (≤ 18)	μs
V_{CESAT}	0.25 (≤ 0.4)			V

Optocouplers
(Optoisolators)

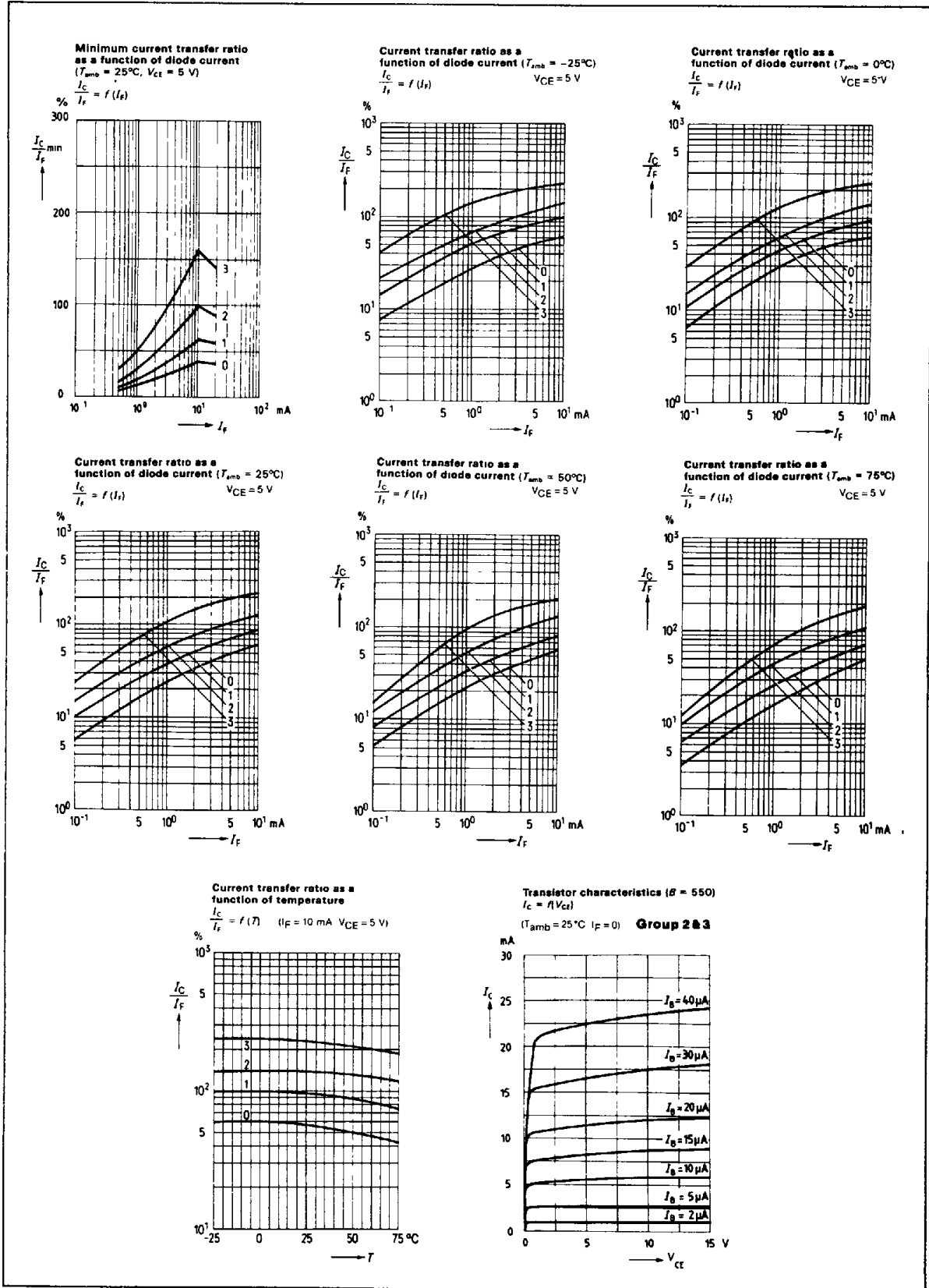

SFH 600

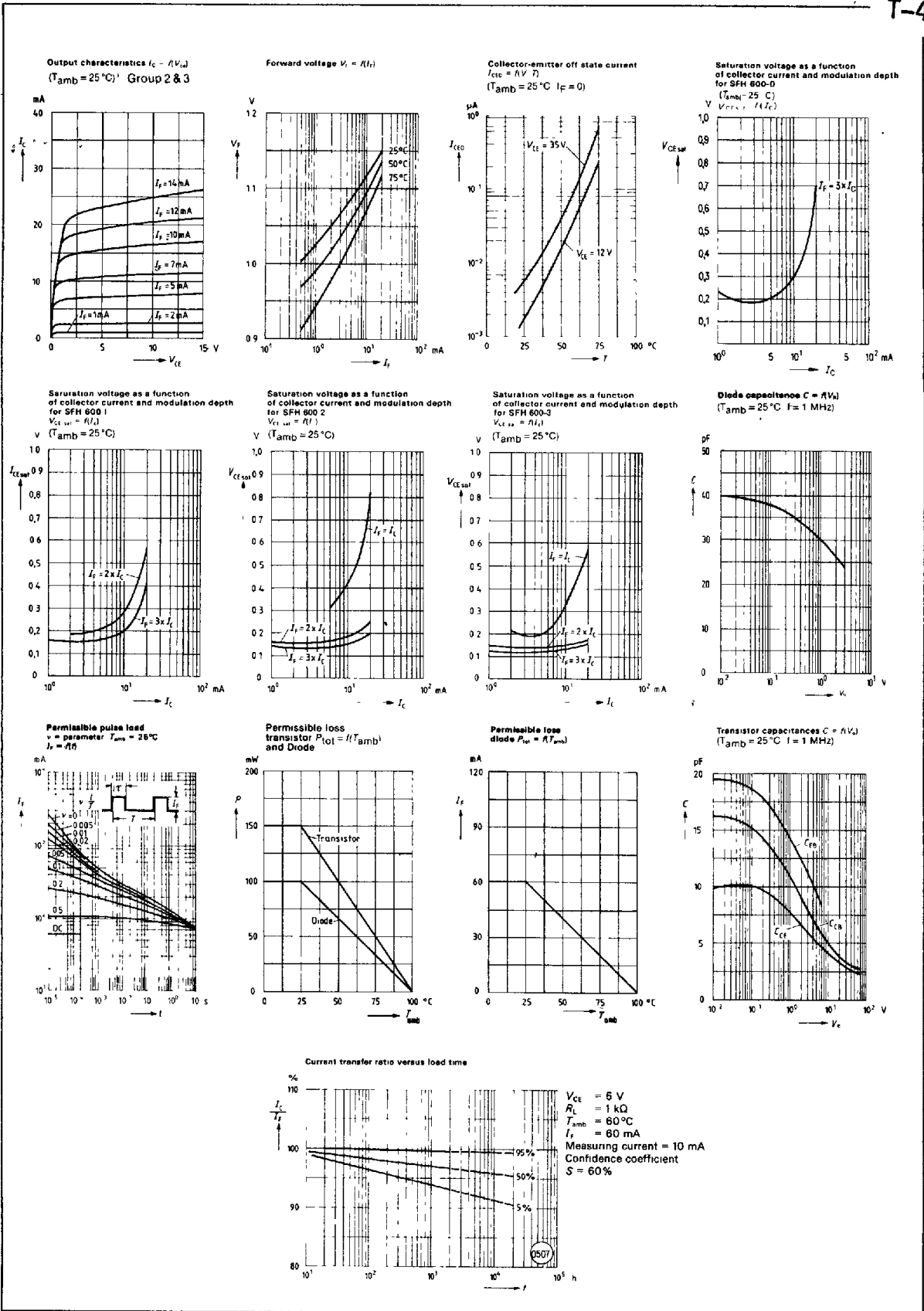

Optocouplers (Optoisolators)