

FEATURES

- **High Current Transfer Ratios**
SFH600-0, 40 to 80%
SFH600-1, 63 to 125%
SFH600-2, 100 to 200%
SFH600-3, 160 to 320%
- **Isolation Test Voltage (1 Sec.), 5300 VACRMS**
- **VCEsat 0.25 (±0.4) V, IF=10 mA, IC=2.5 mA**
- **High Quality Premium Device**
- **Long Term Stability**
- **Storage Temperature, -55∞ to +150∞C**
- **Underwriters Lab File #E52744**
-  **VDE 0884 Available with Option 1**

DESCRIPTION

The SFH600 is an optocoupler with a GaAs LED emitter which is optically coupled with a silicon planar phototransistor detector. The component is packaged in a plastic plug-in case, 20 AB DIN 41866.

The coupler transmits signals between two electrically isolated circuits. The potential difference between the circuits to be coupled is not allowed to exceed the maximum permissible insulating voltage.

Maximum Ratings

Emitter

Reverse Voltage..... 6 V
DC Forward Current..... 60 mA
Surge Forward Current (t_p=10 μs)..... 2.5 A
Total Power Dissipation..... 100 mW

Detector

Collector-Emitter Voltage 70 V
Emitter-Base Voltage 7 V
Collector Current..... 50 mA
Collector Current (t=1 ms)..... 100 mA
Power Dissipation..... 150 mW

Package

Isolation Test Voltage (between emitter and detector referred to climate DIN 40046, part 2, Nov. 74) (t=1 sec.).....5300 VAC_{RMS}
Creepage.....≥7 mm
Clearance≥7 mm
Isolation Thickness between Emitter & Detector≥0.4 mm
Comparative Tracking Index per DIN IEC 112/VDE0303, part 1175
Isolation Resistance
V_{IO}=500 V, T_A=25°C.....≥10¹² Ω
V_{IO}=500 V, T_A=100°C.....≥10¹¹ Ω
Storage Temperature Range..... -55°C to +150°C
Ambient Temperature Range..... -55°C to +100°C
Junction Temperature100°C
Soldering Temperature (max. 10 s, dip soldering: distance to seating plane ≥1.5 mm)260°C

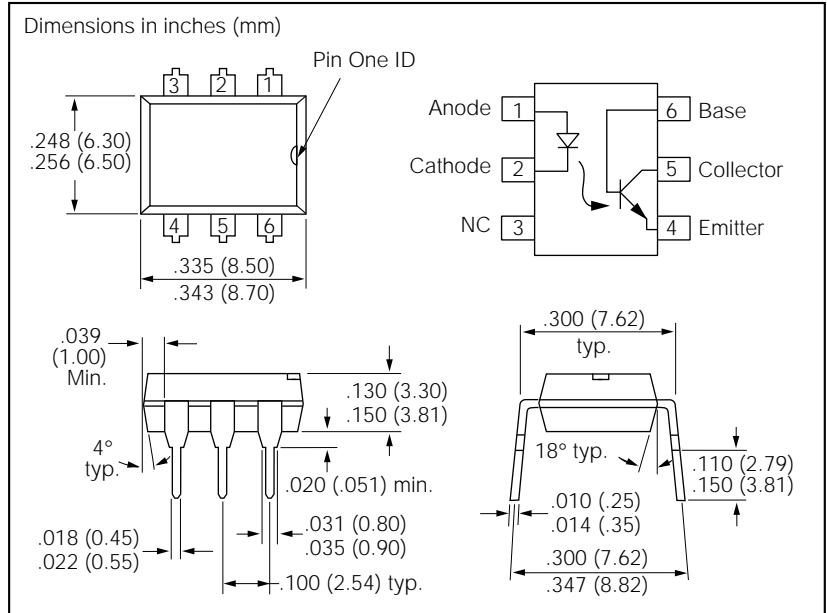

Characteristics (T_A=25°C)

	Symbol		Unit	Condition
Emitter				
Forward Voltage	V _F	1.25 (≤1.65)	V	I _F =60 mA
Breakdown Voltage	V _{BR}	≥6	V	I _R =10 μA
Reverse Current	I _R	0.01 (≤10)	μA	V _R =6 V
Capacitance	C _O	25	pF	V _F =0 V, f=1 MHz
Thermal Resistance	R _{THJamb}	750	°C/W	
Detector				
Capacitance Collector-Emitter Collector-Base Emitter-Base	C _{CCE} C _{CCB} C _{CEB}	5.2 6.5 9.5	pF	f=1 MHz V _{CE} =5 V V _{CB} =5 V V _{EB} =5 V
Thermal Resistance	R _{THJamb}	500	°C/W	
Package				
Saturation Voltage, Collector-Emitter	V _{CEsat}	0.25 (≤0.4)	V	I _F =10 mA, I _C =2.5 mA
Coupling Capacitance	C _{IO}	0.6	pF	V _{IO} =0, f=1 MHz

*TRIOS—TRansparent IO n Shield

Current Transfer Ratio and Collector-Emitter Leakage Current by dash number

	-0	-1	-2	-3	Unit
I_C/I_F at $V_{CE}=5\text{ V}$ ($I_F=10\text{ mA}$)	40-80	63-125	100-200	160-320	%
I_C/I_F at $V_{CE}=5\text{ V}$ ($I_F=1\text{ mA}$)	30 (>13)	45 (>22)	70 (>34)	90 (>56)	%
Collector-Emitter Leakage Current ($V_{CE}=10\text{ V}$) (I_{CEO})	2 (\leq 35)	2 (\leq 35)	2 (\leq 35)	5 (\leq 70)	nA

Figure 1. Linear operation (without saturation)

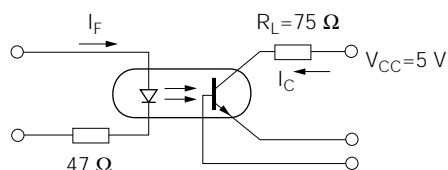

$I_F=10\text{ mA}$, $V_{CC}=5\text{ V}$, $T_A=25\text{ }^\circ\text{C}$, Typical

Load Resistance	R_L	75	Ω
Turn-On Time	t_{ON}	3.2	μs
Rise Time	t_R	2.0	μs
Turn-Off Time	t_{OFF}	3.0	μs
Fall Time	t_f	2.5	μs
Cut-off Frequency	F_{CO}	250	kHz

Figure 2. Switching operation (with saturation)

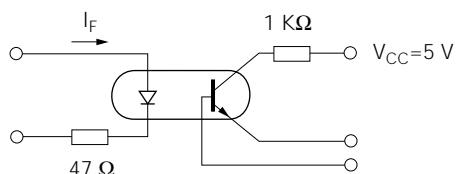

Typical

		-0 ($I_F=20\text{ mA}$)	-1 and -2 ($I_F=10\text{ mA}$)	-3 ($I_F=5\text{ mA}$)	
Turn-On Time	t_{ON}	3.7	4.5	5.8	μs
Rise Time	t_R	2.5	3.0	4.0	μs
Turn-Off Time	t_{OFF}	19	21	24	μs
Fall Time	t_f	11	12	14	μs
	V_{CESAT}	0.25 (\leq 0.4)			V

Figure 3. Current transfer ratio versus diode current

($T_A=-25\text{ }^\circ\text{C}$, $V_{CE}=5\text{ V}$) $I_C/I_F=f(I_F)$

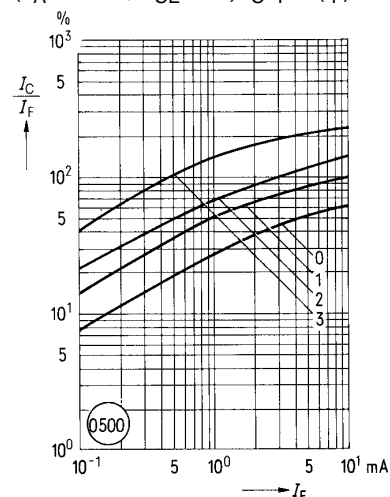

Figure 4. Current transfer ratio versus diode current ($T_A=0\text{ }^\circ\text{C}$, $V_{CE}=5\text{ V}$) $I_C/I_F=f(I_F)$

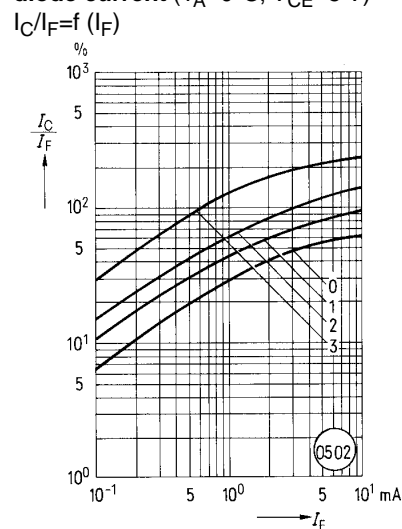
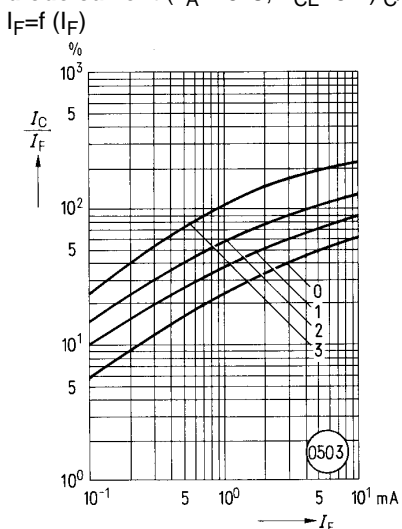
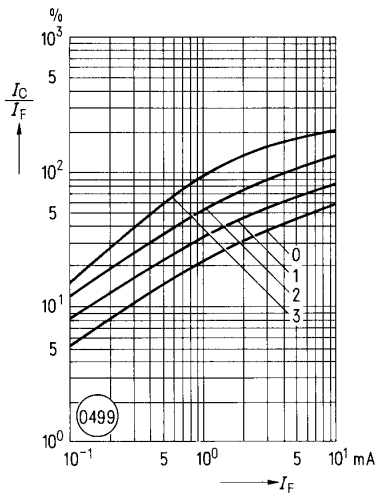

Figure 5. Current transfer ratio versus diode current ($T_A=25\text{ }^\circ\text{C}$, $V_{CE}=5\text{ V}$) $I_C/I_F=f(I_F)$



**Figure 6. Current transfer ratio versus diode current ($T_A=50^\circ\text{C}$) $V_{CE}=5\text{ V}$
 $I_C/I_F=f(I_F)$**



**Figure 7. Current transfer ratio versus diode current ($T_A=75^\circ\text{C}$)
 $V_{CE}=5\text{ V}$ $I_C/I_F=f(I_F)$**

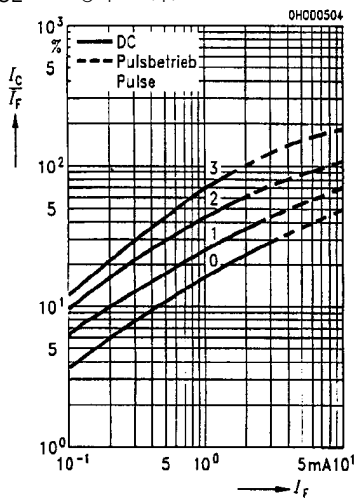

**Figure 8. Current transfer ratio versus temperature ($I_F=10\text{ mA}$, $V_{CE}=5\text{ V}$)
 $I_C/I_F=f(T)$**

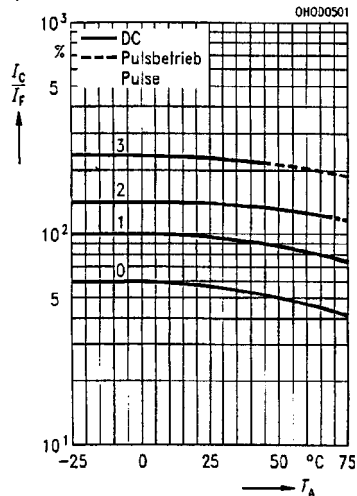

**Figure 9. Transistor characteristics (HFE =550) SFH600-2, -3 $I_C=f(V_{CE})$
($T_A=25^\circ\text{C}$, $I_F=0$)**

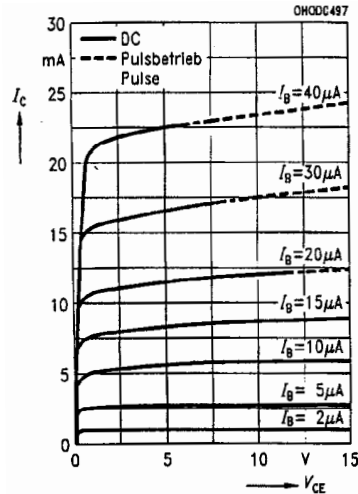

Figure 10. Output characteristics SFH600-2, -3 ($T_A=25^\circ\text{C}$) $I_C=f(V_{CE})$

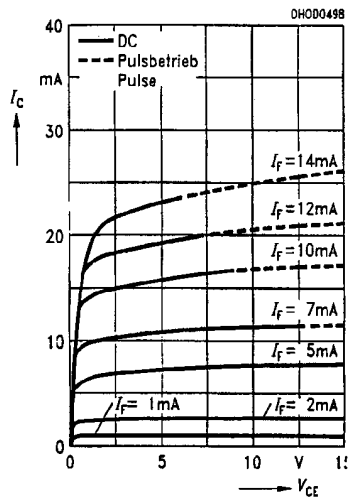
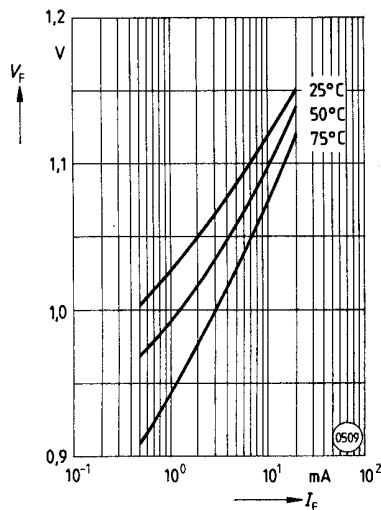
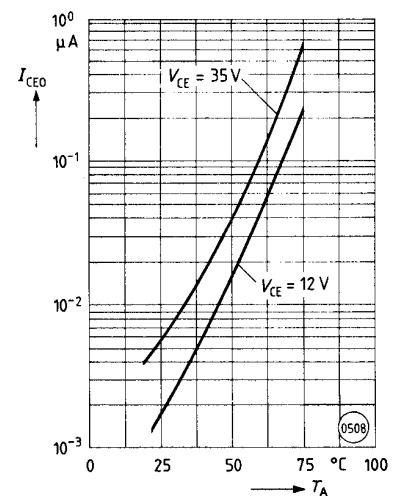

Figure 11. Forward voltage $V_F=f(I_F)$



**Figure 12. Collector emitter off-state current $I_{CEO}=f(V, T)$
($T_A=25^\circ\text{C}$, $I_F=0$)**



**Figure 13. Saturation voltage versus collector current and modulation depth SFH600-0
 $V_{CEsat}=f(I_C)$ ($T_A=25^\circ\text{C}$)**

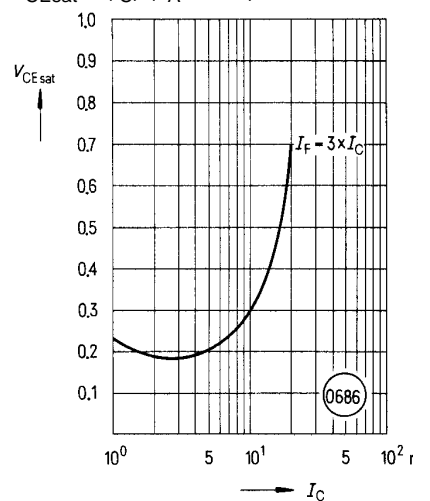

Figure 14. Saturation voltage versus collector current and modulation depth SFH600-1 $V_{CEsat}=f(I_C)$ ($T_A=25^\circ\text{C}$)

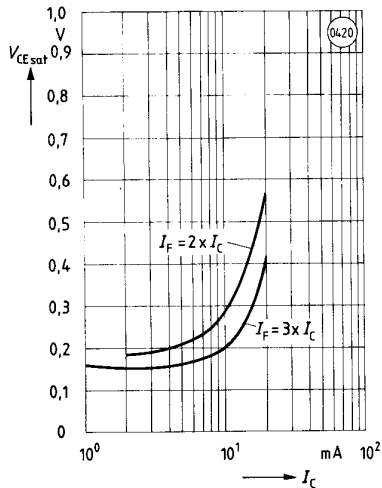

Figure 15. Saturation voltage versus collector current and modulation depth SFH600-2 $V_{CEsat}=f(I_C)$ ($T_A=25^\circ\text{C}$)

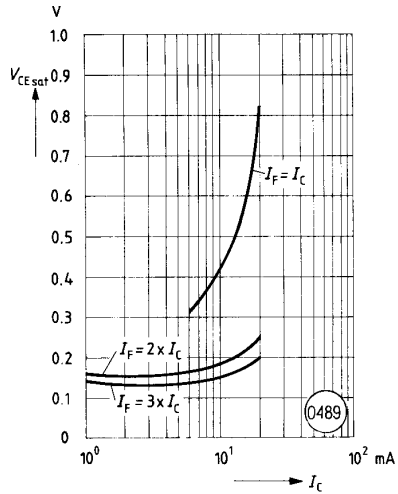

Figure 16. Saturation voltage versus collector current and modulation depth SFH600-3 $V_{CEsat}=f(I_C)$ ($T_A=25^\circ\text{C}$)

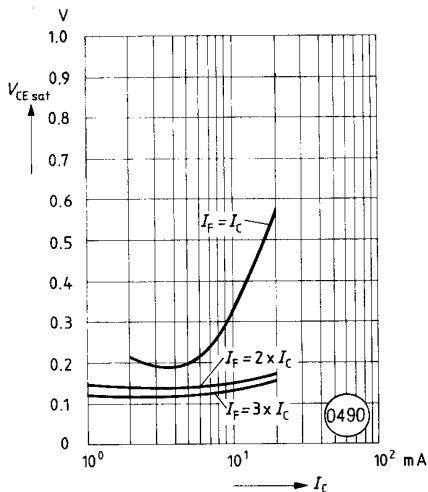

Figure 17. Permissible pulse load $D=\text{parameter}$, $T_A=25^\circ\text{C}$, $I_F=f(t_p)$

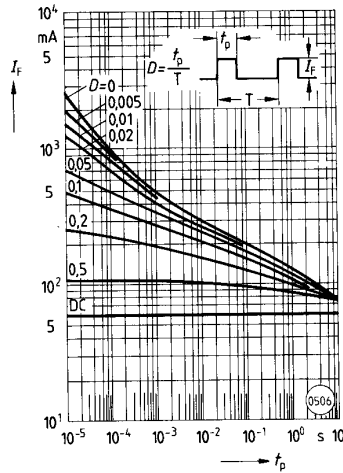

Figure 18. Permissible power dissipation for transistor and diode $P_{tot}=f(T_A)$

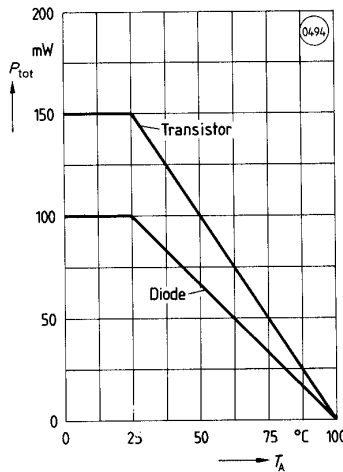

Figure 19. Permissible forward current diode $P_{tot}=f(T_A)$

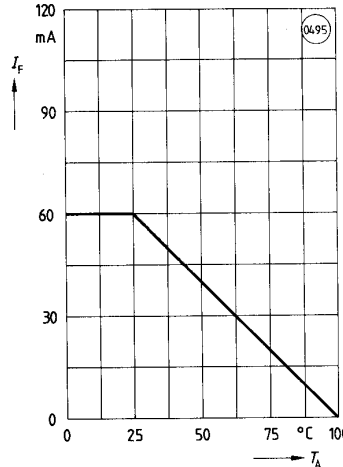

Figure 20. Transistor capacitance $C=f(V_e)$ ($T_A=25^\circ\text{C}$, $f=1\text{ MHz}$)

