

FEATURES

- **Very High CTR at $I_F=1.0$ mA, $V_{CE}=0.5$ V**
 - SFH618A-2, 63–125%
 - SFH618A-3, 100–200%
 - SFH618A-4, 160–320%
 - SFH618A-5, 250–500%
 - SFH628A-2, 63–200%
 - SFH628A-3, 100–320%
 - SFH628A-4, 160–500%
- **Specified Minimum CTR at $I_F=0.5$ mA**
 - SFH618A, $V_{CE}=1.5$ V: $\geq 32\%$ (typical 120%)
 - SFH628A, $V_{CE}=1.5$ V: $\geq 50\%$ (typical 160%)
- **Good CTR Linearity Depending on Forward Current**
- **Low CTR Degradation**
- **High Collector-emitter Voltage, $V_{CEO}=55$ V**
- **Isolation Test Voltage, 5300 V_{RMS}**
- **Low Coupling Capacitance**
- **Field-Effect Stable by TRIOS (TTransparent Ion Shield)**
- **End-Stackable, 0.100" (2.54 mm) Spacing**
- **High Common-mode Interference Immunity (Unconnected Base)**
- **Underwriters Lab File #52744**
- **VDE 0884 Available with Option 1**
- **SMD Option — See SFH6186/6286 Data Sheet**

APPLICATIONS

- **Telecom**
- **Industrial Controls**
- **Battery Powered Equipment**
- **Office Machines**

DESCRIPTION

The SFH618A/628A feature a high current transfer ratio, low coupling capacitance and high isolation voltage. These couplers have a GaAs infrared emitting diode emitter, which is optically coupled to a silicon planar phototransistor detector, and is incorporated in a plastic DIP-4 package.

The coupling devices are designed for signal transmission between two electrically separated circuits.

The couplers are end-stackable with 2.54 mm lead spacing.

Creepage and clearance distances of >8.0 mm are achieved with option 6. This version complies with IEC 950 (DIN VDE 0805) for reinforced insulation up to an operation voltage of 400 V_{RMS} or DC.

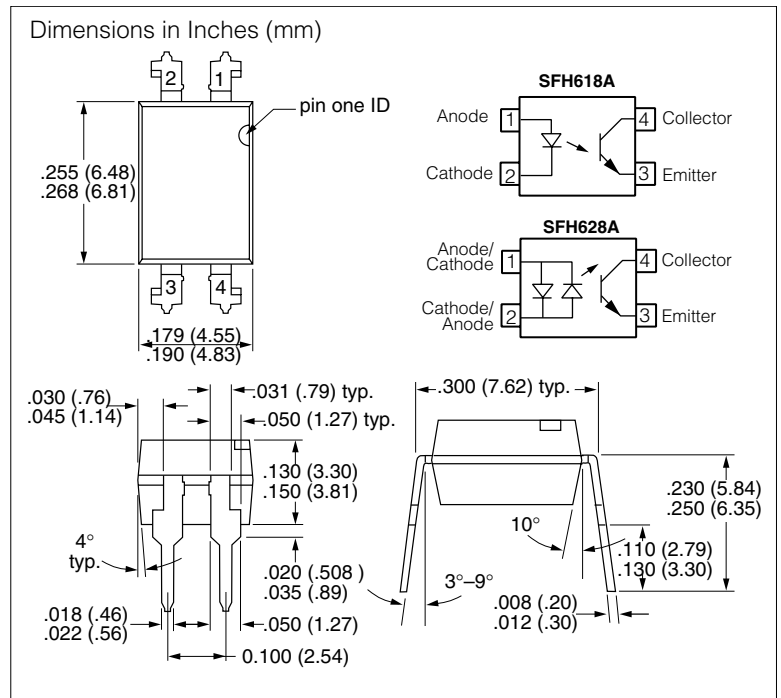

Maximum Ratings

Emitter

| | |
|---|--------|
| Reverse Voltage (SFH618A) | 6.0 V |
| DC Forward Current (SFH628A) | ±50 mA |
| Surge Forward Current ($t_p \leq 10 \mu s$) (SFH628A) | ±2.5 A |
| Total Power Dissipation | 70 mW |

Detector

| | |
|--|--------|
| Collector-emitter Voltage | 55 V |
| Emitter-collector Voltage | 7.0 V |
| Collector Current | 50 mA |
| Collector Current ($t_p \leq 1.0$ ms) | 100 mA |
| Total Power Dissipation | 150 mW |

Package

| | |
|--|-----------------------|
| Isolation Test Voltage between Emitter and Detector, refer to Climate DIN 40046, part 2, Nov. 74 | 5300 V _{RMS} |
| Creepage Distance | ≥ 7.0 mm |
| Clearance | ≥ 7.0 mm |
| Insulation Thickness between Emitter and Detector | ≥ 0.4 mm |
| Comparative Tracking Index per DIN IEC 112/VDE0 303, part 1 | 175 |
| Isolation Resistance | |
| $V_{IO}=500$ V, $T_A=25^\circ C$ | $\geq 10^{12} \Omega$ |
| $V_{IO}=500$ V, $T_A=100^\circ C$ | $\geq 10^{11} \Omega$ |
| Storage Temperature Range | -55 to +150°C |
| Ambient Temperature Range | -55 to +100°C |
| Junction Temperature | 100°C |
| Soldering Temperature (max. 10 s. Dip Soldering) | |
| Distance to Seating Plane ≥ 1.5 mm) | 260°C |

Characteristics ($T_A=25^\circ\text{C}$)

| Description | | Symbol | Min. | Typ. | Max. | Unit | Condition |
|--------------------------------------|--------------------|-------------|------|----------|------|---------------|---|
| Emitter | | | | | | | |
| Forward Voltage | | V_F | — | 1.1 | 1.5 | V | $I_F=5.0\text{ mA}$ |
| Reverse Current | SFH618A | I_R | — | .01 | 10 | μA | $V_R=6.0\text{ V}$ |
| Capacitance | SFH618A SFH628A | C_0 | — | 25 45 | — | pF | $V_R=0\text{ V}$, $f=1.0\text{ MHz}$ |
| Thermal Resistance | | R_{thJA} | — | 1070 | — | K/W | — |
| Detector | | | | | | | |
| Collector-emitter Leakage Current | | I_{CEO} | — | 10 | 200 | nA | $V_{CE}=10\text{ V}$ |
| Capacitance | | C_{CE} | — | 7 | — | pF | $V_{CE}=5.0\text{ V}$, $f=1.0\text{ MHz}$ |
| Thermal Resistance | | R_{thJA} | — | 500 | — | K/W | — |
| Package | | | | | | | |
| Collector-emitter Saturation Voltage | SFH618A-2 | V_{CEsat} | — | 0.25 | 0.4 | V | $I_C=0.32\text{ mA}$, $I_F=1.0\text{ mA}$ |
| | SFH618A-3 | | — | 0.25 | 0.4 | | $I_C=0.5\text{ mA}$, $I_F=1.0\text{ mA}$ |
| | SFH618A-4 | | — | 0.25 | 0.4 | | $I_C=0.8\text{ mA}$, $I_F=1.0\text{ mA}$ |
| | SFH618A-5 | | — | 0.25 | 0.4 | | $I_C=1.25\text{ mA}$, $I_F=1.0\text{ mA}$ |
| Collector-emitter Saturation Voltage | SFH628A-2 | V_{CEsat} | — | 0.25 | 0.4 | V | $I_C=0.5\text{ mA}$, $I_F=\pm 1.0\text{ mA}$ |
| | SFH628A-3 | | — | 0.25 | 0.4 | | $I_C=0.8\text{ mA}$, $I_F=\pm 1.0\text{ mA}$ |
| | SFH628A-4 | | — | 0.25 | 0.4 | | $I_C=1.25\text{ mA}$, $I_F=\pm 1.0\text{ mA}$ |
| Coupling Capacitance | — | C_C | — | 0.25 | — | pF | — |
| Coupling Transfer Ratio | SFH618A-2 | I_C/I_F | 63 | — | 125 | % | $I_F=1.0\text{ mA}$, $V_{CE}=0.5\text{ V}$ |
| | SFH618A-2 | | 32 | 75 | — | | $I_F=0.5\text{ mA}$, $V_{CE}=1.5\text{ V}$ |
| | SFH618A-3 | I_C/I_F | 100 | — | 200 | % | $I_F=1.0\text{ mA}$, $V_{CE}=0.5\text{ V}$ |
| | SFH618A-3 | | 50 | 120 | — | | $I_F=0.5\text{ mA}$, $V_{CE}=1.5\text{ V}$ |
| | SFH618A-4 | I_C/I_F | 160 | — | 320 | % | $I_F=1.0\text{ mA}$, $V_{CE}=0.5\text{ V}$ |
| | SFH618A-4 | | 80 | 200 | — | | $I_F=0.5\text{ mA}$, $V_{CE}=1.5\text{ V}$ |
| | SFH618A-5 | I_C/I_F | 250 | — | 500 | % | $I_F=1.0\text{ mA}$, $V_{CE}=0.5\text{ V}$ |
| | SFH618A-5 | | 125 | 300 | — | | $I_F=0.5\text{ mA}$, $V_{CE}=1.5\text{ V}$ |
| Coupling Transfer Ratio | SFH628A-2 | I_C/I_F | 63 | — | 200 | % | $I_F=\pm 1.0\text{ mA}$, $V_{CE}=0.5\text{ V}$ |
| | SFH628A-2 | | 32 | 100 | — | | $I_F=\pm 0.5\text{ mA}$, $V_{CE}=1.5\text{ V}$ |
| | SFH628A-3 | I_C/I_F | 100 | — | 320 | % | $I_F=\pm 1.0\text{ mA}$, $V_{CE}=0.5\text{ V}$ |
| | SFH628A-3 | | 50 | 160 | — | | $I_F=\pm 0.5\text{ mA}$, $V_{CE}=1.5\text{ V}$ |
| | SFH628A-4 | I_C/I_F | 160 | — | 500 | % | $I_F=\pm 1.0\text{ mA}$, $V_{CE}=0.5\text{ V}$ |
| | SFH628A-4 | | 80 | 250 | — | | $I_F=\pm 0.5\text{ mA}$, $V_{CE}=1.5\text{ V}$ |

Figure 1. Current Transfer Ratio (typ.)
 $V_{CE}=0.5\text{ V}$, $C_{TR}=f(T_A)$

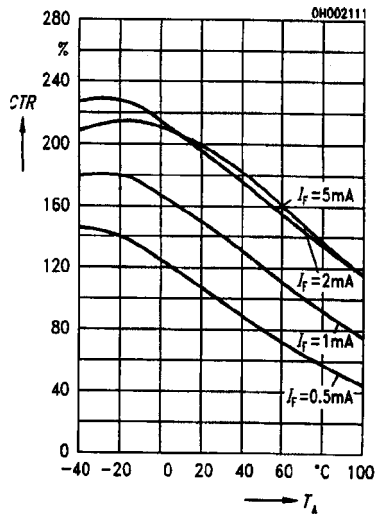

Figure 2. Current Transfer Ratio (typ.)
 $V_{CE}=1.5\text{ V}$, $C_{TR}=f(T_A)$

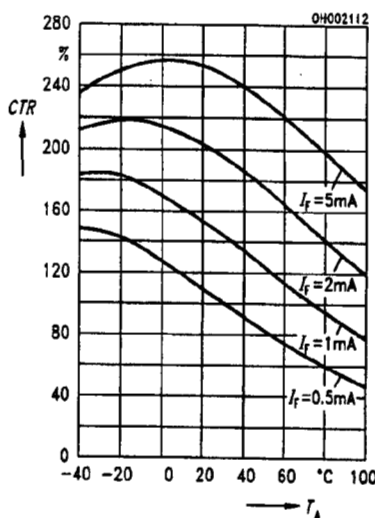

Figure 3. Diode Forward Voltage
 $T_A=25^\circ\text{C}$, $V_F=f(I_F)$

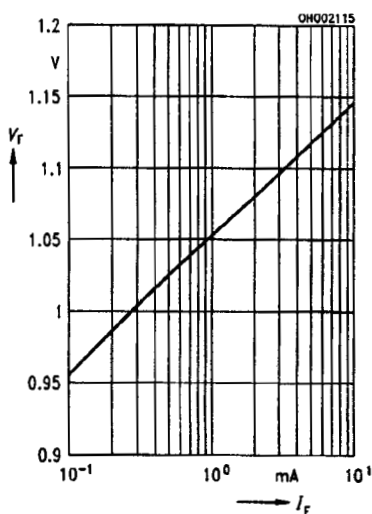

Figure 4. Diode Forward Voltage
 $I_F=1.0\text{ mA}$, $V_F=f(T_A)$

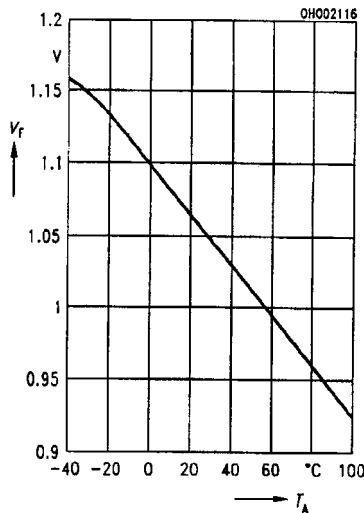

Figure 5. Transistor Capacitance
 $T_A=25^\circ\text{C}$, $f=1.0\text{ MHz}$, $C_{CE}=f(V_{CE})$

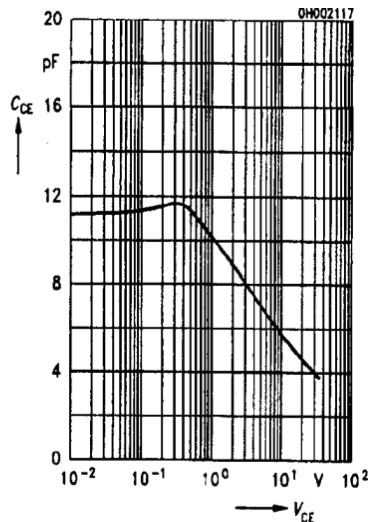

Figure 6. Output Characteristics
 $T_A=25^\circ\text{C}$, $C_E=f(V_{CE}, I_F)$

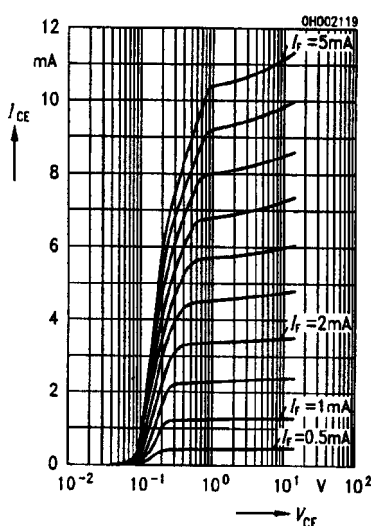

Figure 7. Permissible Forward Current
 $I_F=f(T_A)$

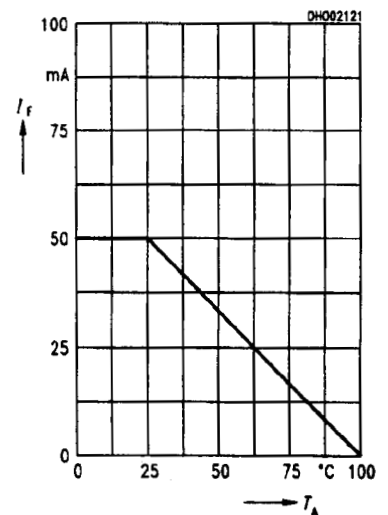

Figure 8. Permissible Power Dissipation
 $P_{tot}=f(T_A)$

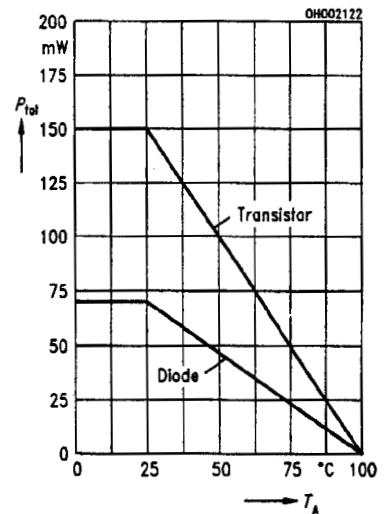
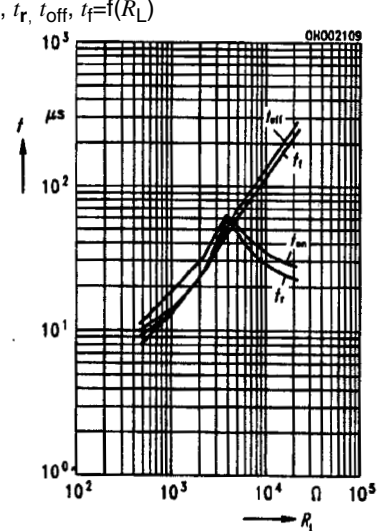

Figure 9. Switching Times (typ.)
 $T_A=25^\circ\text{C}$, $I_F=1.0\text{ mA}$, $V_{CC}=5.0\text{ V}$
 $t_{on}, t_r, t_{off}, t_f=f(R_L)$



Switching Times, typical

$V_{CC}=5.0\text{ V}$, $I_C=2.0\text{ mA}$, $R_L=100\ \Omega$, $T_A=25^\circ\text{C}$

| | | | |
|---------------|-----------|-----|---------------|
| Turn-on Time | t_{on} | 6.0 | μs |
| Rise Time | t_r | 3.5 | |
| Turn-off Time | t_{off} | 5.5 | |
| Fall Time | t_f | 5.0 | |

Figure 10. Test Circuit—SFH618A

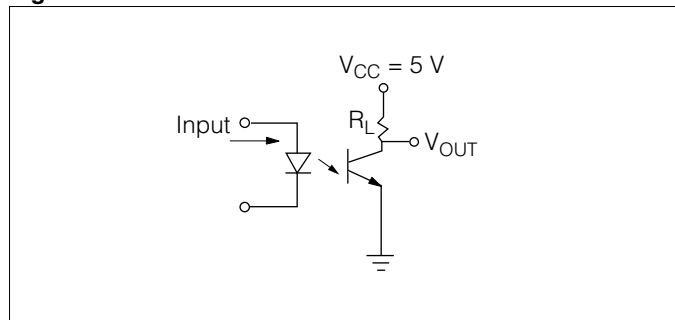

Figure 11. Test Circuit—SFH628A

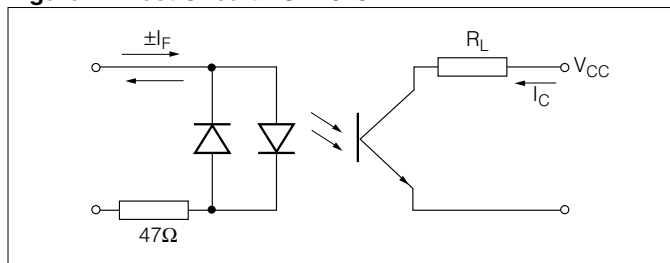

Figure 12. Test Circuit and Waveforms

