

## Optocoupler, Phototransistor Output, SOT-223/10, Quad Channel

### Features

- Transistor Optocoupler in SOT-223/10 Package
- End Stackable, 1.27 mm Spacing
- Low Current Input
- Good CTR Linearity Versus Forward Current
- Minor CTR Degradation
- High Collector-Emitter Voltage,  $V_{CEO} = 70\text{ V}$
- Low Coupling Capacitance
- High Common Mode Transient Immunity
- Isolation Test Voltage:  $1768\text{ V}_{RMS}$
- Lead-(Pb)-free component
- Component in accordance to RoHS 2002/95/EC and WEEE 2002/96/EC

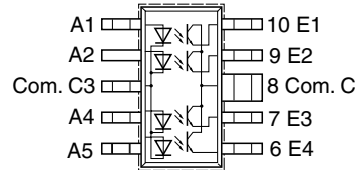
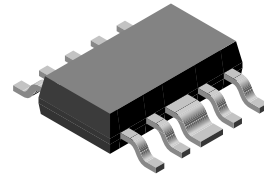

i179077

### Agency Approvals

- UL1577, File No. E52744 System Code V
- CSA 93751

### Applications

- Telecommunication
- SMT
- PCMCIA
- Instrumentation

### Description

The SFH6943A is a four channel mini-optocoupler suitable for high density packaged PCB application. It has a minimum of  $1768\text{ V}_{RMS}$  isolation from input to output. The device consists of four phototransistors as detectors. Each channel is individually controlled. The optocoupler is housed in a SOT-223/10 package. All the cathodes of the input LEDs and all the collectors of the output transistors are common enabling a pin count reduction from 16 pins to 10 pins-a significant space savings as compared to four channels that are electrically isolated individually.

### Order Information

Part	Remarks
SFH6943A-2	CTR 63 - 200 %, SMD-10
SFH6943A-3	CTR 100 - 320 %, SMD-10
SFH6943A-4	CTR 160 - 500 %, SMD-10

### Absolute Maximum Ratings

$T_{amb} = 25\text{ }^{\circ}\text{C}$ , unless otherwise specified

Stresses in excess of the absolute Maximum Ratings can cause permanent damage to the device. Functional operation of the device is not implied at these or any other conditions in excess of those given in the operational sections of this document. Exposure to absolute Maximum Rating for extended periods of the time can adversely affect reliability.

### Input

Parameter	Test condition	Symbol	Value	Unit
Reverse voltage		$V_R$	3	V
DC forward current		$I_F$	5	mA
Surge forward current	$t_p \leq 10\text{ }\mu\text{s}$	$I_{FSM}$	100	mA
Total power dissipation		$P_{diss}$	10	mW

### Output

Parameter	Test condition	Symbol	Value	Unit
Collector-emitter voltage		$V_{CE}$	70	V
Emitter-collector voltage		$V_{EC}$	7	V
Collector current		$I_C$	10	mA
Surge collector current	$t_p < 1\text{ ms}$	$I_{FSM}$	20	mA
Total power dissipation		$P_{diss}$	20	mW

### Coupler

Parameter	Test condition	Symbol	Value	Unit
Isolation test voltage (between emitter and detector, refer to climate DIN 40046, part 2, Nov. 74)	$t = 1\text{ sec.}$	$V_{ISO}$	1768	$V_{RMS}$
Creepage			$\geq 4$	mm
Clearance			$\geq 4$	mm
Comparative tracking index per DIN IEC 112/VDE0303, part 1			175	
Isolation resistance	$V_{IO} = 100\text{ V}, T_{amb} = 25\text{ }^{\circ}\text{C}$	$R_{IO}$	$\geq 10^{11}$	$\Omega$
	$V_{IO} = 100\text{ V}, T_{amb} = 100\text{ }^{\circ}\text{C}$	$R_{IO}$	$\geq 10^{12}$	$\Omega$
Storage temperature range		$T_{stg}$	- 55 to + 150	$^{\circ}\text{C}$
Ambient temperature range		$T_{amb}$	- 55 to + 100	$^{\circ}\text{C}$
Junction temperature		$T_j$	100	$^{\circ}\text{C}$
Soldering temperature, Dip soldering plus reflow soldering processes	$t = 10\text{ sec. max}$	$T_{sld}$	260	$^{\circ}\text{C}$

## Electrical Characteristics

$T_{amb} = 25\text{ }^{\circ}\text{C}$ , unless otherwise specified

Minimum and maximum values are testing requirements. Typical values are characteristics of the device and are the result of engineering evaluation. Typical values are for information only and are not part of the testing requirements.

### Input

Parameter	Test condition	Symbol	Min	Typ.	Max	Unit
Forward voltage	$I_F = 5\text{ mA}$	$V_F$		1.25		V
Reverse current	$V_R = 3\text{ V}$	$I_R$		0.01	10	$\mu\text{A}$
Capacitance	$V_R = 0\text{ V}$ , $f = 1\text{ MHz}$	$C_O$		5		pF
Thermal resistance		$R_{thja}$		1000		K/W

### Output

Parameter	Test condition	Symbol	Min	Typ.	Max	Unit
Collector-emitter voltage	$I_{CE} = 10\text{ }\mu\text{A}$	$V_{CEO}$	70			V
Emitter-collector voltage	$I_{EC} = 10\text{ }\mu\text{A}$	$V_{ECO}$	7			V
Collector-emitter capacitance	$V_{CE} = 5\text{ V}$ , $f = 1\text{ MHz}$	$C_{CE}$		6		pF
Thermal resistance		$R_{thja}$		500		K/W
Collector-emitter leakage current	$V_{CE} = 10\text{ V}$	$I_{CEO}$		50		nA

### Coupler

Parameter	Test condition	Symbol	Min	Typ.	Max	Unit
Coupling capacitance		$C_C$		1		pF

### Current Transfer Ratio

Parameter	Test condition	Part	Symbol	Min	Typ.	Max	Unit
Coupling Transfer Ratio	$I_F = 1\text{ mA}$ , $V_{CE} = 1.5\text{ V}$	SFH6943A-2	$I_E/I_F$	63		200	%
		SFH6943A-3	$I_E/I_F$	100		320	%
		SFH6943A-4	$I_E/I_F$	160		500	%
	$I_F = 0.5\text{ mA}$ , $V_{CC} = 5\text{ V}$	SFH6943A-2	$I_E/I_F$	32	100		%
		SFH6943A-3	$I_E/I_F$	50	160		%
		SFH6943A-4	$I_E/I_F$	80	250		%

### Switching Characteristics

Parameter	Test condition	Symbol	Min	Typ.	Max	Unit
Turn-on time	$I_E = 2\text{ mA}$ , $R_E = 100\text{ }\Omega$ , $V_{CC} = 5\text{ V}$	$t_{on}$		3		$\mu\text{s}$
Rise time	$I_E = 2\text{ mA}$ , $R_E = 100\text{ }\Omega$ , $V_{CC} = 5\text{ V}$	$t_r$		2.6		$\mu\text{s}$
Turn-off time	$I_E = 2\text{ mA}$ , $R_E = 100\text{ }\Omega$ , $V_{CC} = 5\text{ V}$	$t_{off}$		3.1		$\mu\text{s}$
Fall time	$I_E = 2\text{ mA}$ , $R_E = 100\text{ }\Omega$ , $V_{CC} = 5\text{ V}$	$t_f$		2.8		$\mu\text{s}$

## Typical Characteristics

$T_{amb} = 25\text{ }^{\circ}\text{C}$ , unless otherwise specified

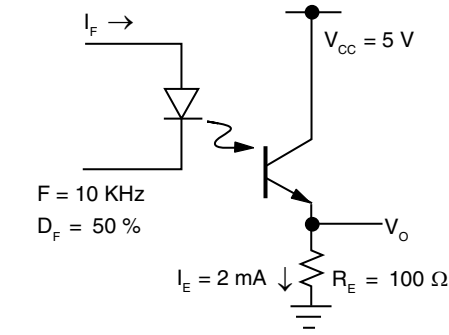

isfh6943\_01

Figure 1. Switching times (typ.)

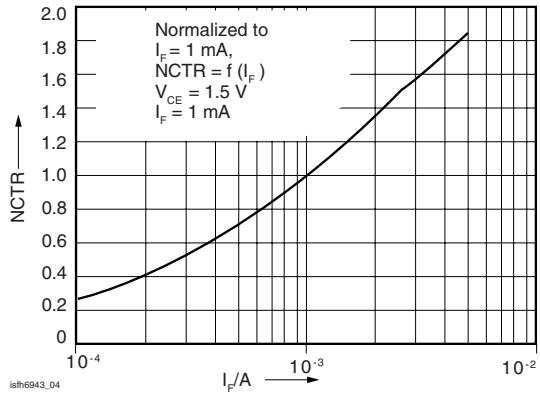

isfh6943\_04

Figure 4. Non-Saturated Current Transfer

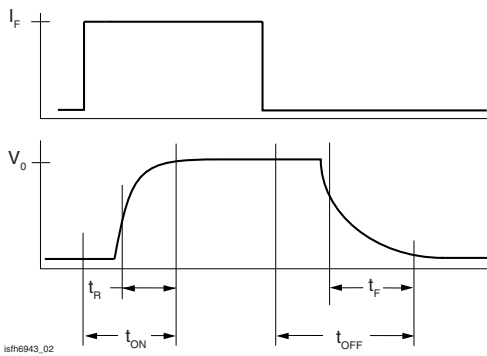

isfh6943\_02

Figure 2. Switching Waveform

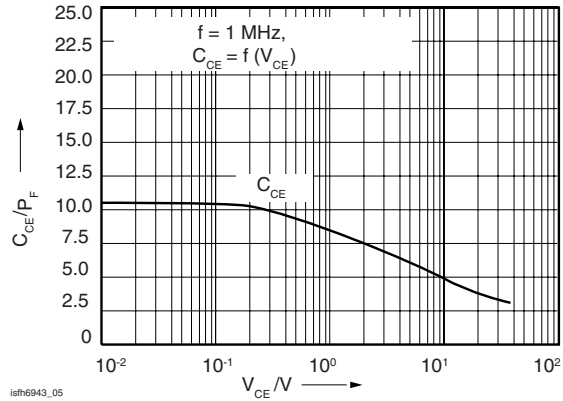

isfh6943\_05

Figure 5. Transistor Capacitances (typ.)

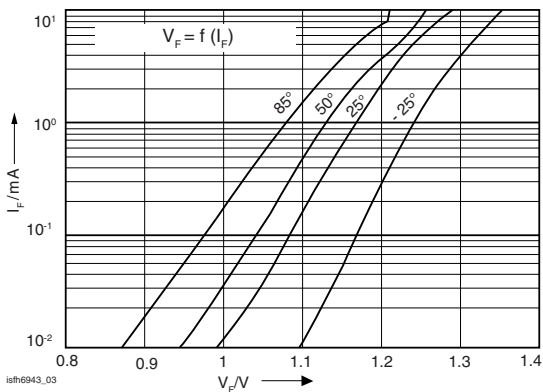

isfh6943\_03

Figure 3. LED Current vs. LED Voltage

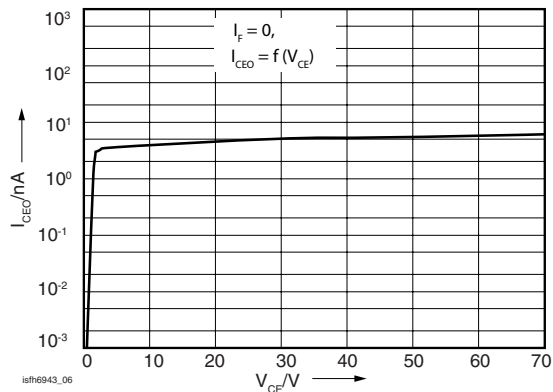

isfh6943\_06

Figure 6. Collector-Emitter Leakage Current (typ.)

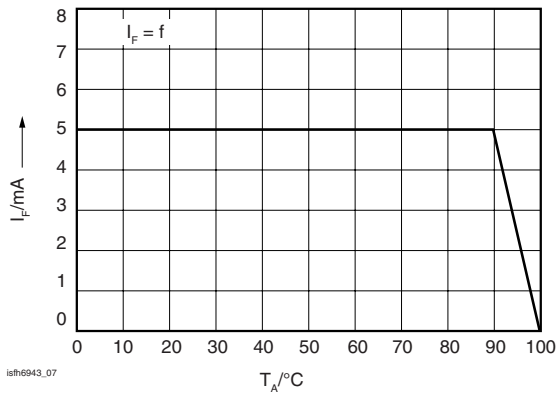

Figure 7. Permissible Forward Current Diode

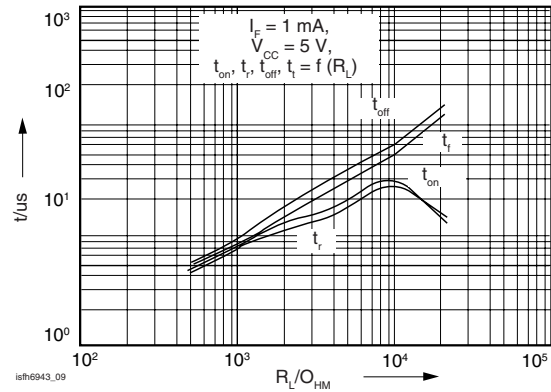

Figure 9.

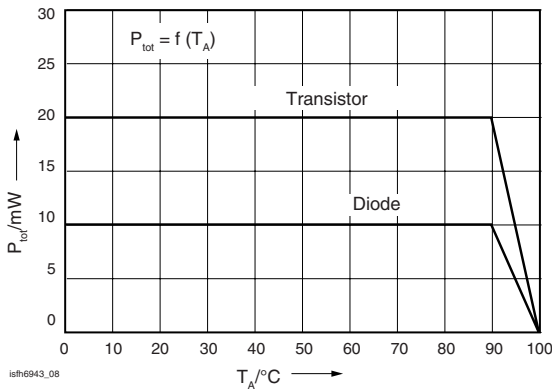

Figure 8. Permissible Power Dissipation

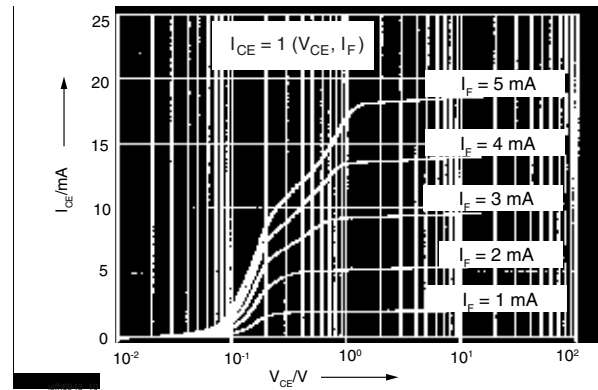
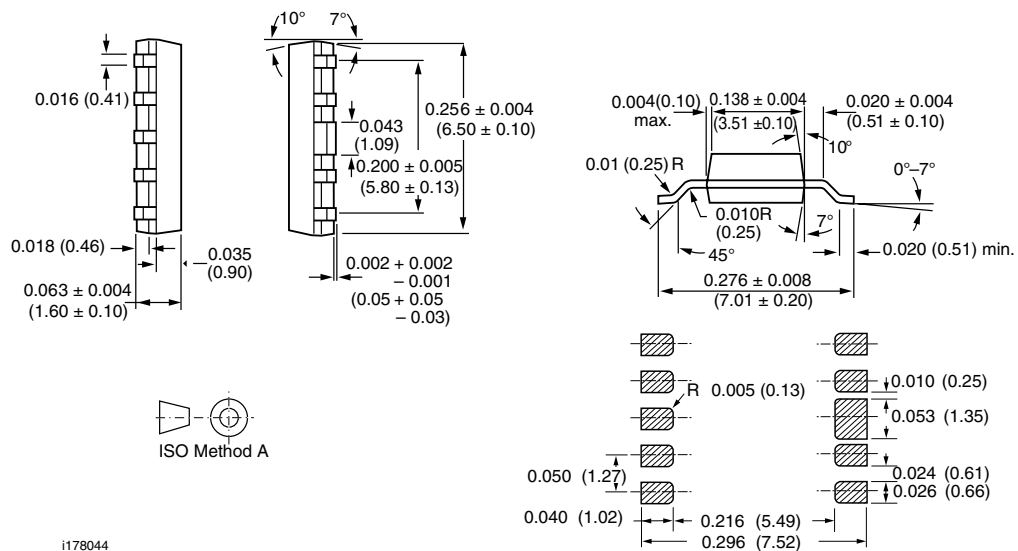

Figure 10. Transistor Output Characteristics

## Package Dimensions in Inches (mm)



i178044

### Ozone Depleting Substances Policy Statement

It is the policy of Vishay Semiconductor GmbH to

1. Meet all present and future national and international statutory requirements.
2. Regularly and continuously improve the performance of our products, processes, distribution and operating systems with respect to their impact on the health and safety of our employees and the public, as well as their impact on the environment.

It is particular concern to control or eliminate releases of those substances into the atmosphere which are known as ozone depleting substances (ODSs).

The Montreal Protocol (1987) and its London Amendments (1990) intend to severely restrict the use of ODSs and forbid their use within the next ten years. Various national and international initiatives are pressing for an earlier ban on these substances.

Vishay Semiconductor GmbH has been able to use its policy of continuous improvements to eliminate the use of ODSs listed in the following documents.

1. Annex A, B and list of transitional substances of the Montreal Protocol and the London Amendments respectively
2. Class I and II ozone depleting substances in the Clean Air Act Amendments of 1990 by the Environmental Protection Agency (EPA) in the USA
3. Council Decision 88/540/EEC and 91/690/EEC Annex A, B and C (transitional substances) respectively.

Vishay Semiconductor GmbH can certify that our semiconductors are not manufactured with ozone depleting substances and do not contain such substances.

We reserve the right to make changes to improve technical design  
and may do so without further notice.

Parameters can vary in different applications. All operating parameters must be validated for each customer application by the customer. Should the buyer use Vishay Semiconductors products for any unintended or unauthorized application, the buyer shall indemnify Vishay Semiconductors against all claims, costs, damages, and expenses, arising out of, directly or indirectly, any claim of personal damage, injury or death associated with such unintended or unauthorized use.

Vishay Semiconductor GmbH, P.O.B. 3535, D-74025 Heilbronn, Germany



## Notice

Specifications of the products displayed herein are subject to change without notice. Vishay Intertechnology, Inc., or anyone on its behalf, assumes no responsibility or liability for any errors or inaccuracies.

Information contained herein is intended to provide a product description only. No license, express or implied, by estoppel or otherwise, to any intellectual property rights is granted by this document. Except as provided in Vishay's terms and conditions of sale for such products, Vishay assumes no liability whatsoever, and disclaims any express or implied warranty, relating to sale and/or use of Vishay products including liability or warranties relating to fitness for a particular purpose, merchantability, or infringement of any patent, copyright, or other intellectual property right.

The products shown herein are not designed for use in medical, life-saving, or life-sustaining applications. Customers using or selling these products for use in such applications do so at their own risk and agree to fully indemnify Vishay for any damages resulting from such improper use or sale.