

## SI-3000C Series

# 5-Terminal, Multi-Function, Full-Mold, Low Dropout Voltage Dropper Type

### ■Features

- Compact full-mold package (equivalent to TO220)
- Output current: 1.5A
- Low dropout voltage:  $V_{DI} \leq 1V$  (at  $I_o = 1.5A$ )
- Variable output voltage (rise only)  
May be used for remote sensing
- Output ON/OFF control terminal is compatible with LS-TTL.  
(It may be directly driven by LS-TTL or standard CMOS logic.)
- Built-in foldback overcurrent (SI-3033C: Drooping type overcurrent), overvoltage, thermal protection circuits

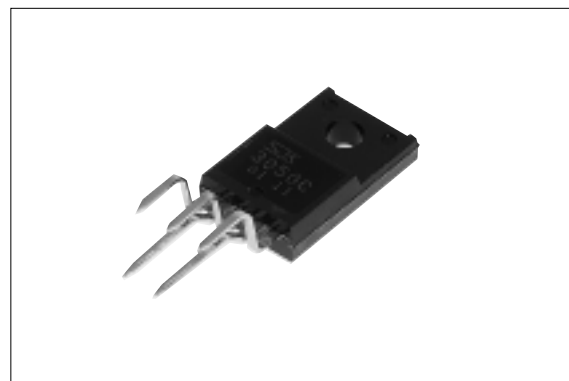

### ■Applications

- For stabilization of the secondary stage of switching power supplies
- Electronic equipment

### ■Absolute Maximum Ratings

(T<sub>a</sub>=25°C)

Parameter	Symbol	Ratings				Unit
		SI-3033C	SI-3050C/3090C	SI-3120C/3150C	SI-3240C	
DC Input Voltage	V <sub>IN</sub>	20	35	35	45	V
Voltage of Output Control Terminal	V <sub>c</sub>	V <sub>IN</sub>				V
DC Output Current	I <sub>o</sub>	1.5 <sup>2</sup>				A
Power Dissipation	P <sub>D1</sub>	18(With infinite heatsink)				W
	P <sub>D2</sub>	1.5(Without heatsink, stand-alone operation)				W
Junction Temperature	T <sub>j</sub>	-40 to +125				°C
Ambient Operating Temperature	T <sub>op</sub>	-30 to +100				°C
Storage Temperature	T <sub>stg</sub>	-40 to +125				°C
Thermal Resistance (junction to case)	R <sub>th(j-c)</sub>	5.5				°C/W
Thermal Resistance (junction to ambient air)	R <sub>th(j-a)</sub>	66.7(Without heatsink, stand-alone operation)				°C/W

■Electrical Characteristics

(T<sub>a</sub>=25°C unless otherwise specified)

Parameter	Symbol	Ratings									Unit
		SI-3033C			SI-3050C			SI-3090C			
		min.	typ.	max.	min.	typ.	max.	min.	typ.	max.	
Input Voltage	V <sub>IN</sub>	*3		15 <sup>2</sup>	6 <sup>3</sup>		30 <sup>2</sup>	10 <sup>3</sup>		30 <sup>2</sup>	V
Output Voltage	SI-3000C <sup>*1</sup>	3.168	3.300	3.432	4.80	5.00	5.20	8.64	9.00	9.36	V
	SI-3000CA	3.234	3.300	3.366	4.90	5.00	5.10	8.82	9.00	9.18	
Dropout Voltage	Conditions	V <sub>IN</sub> =5V, I <sub>o</sub> =1.0A			V <sub>IN</sub> =8V, I <sub>o</sub> =1.0A			V <sub>IN</sub> =12V, I <sub>o</sub> =1.0A			V
	V <sub>DIF</sub>			0.5			0.5			0.5	
	Conditions	I <sub>o</sub> ≤1.0A									
Line Regulation	Conditions			1.0			1.0			1.0	mV
	Conditions	I <sub>o</sub> ≤1.5A									
Load Regulation	ΔV <sub>OLINE</sub>		10	30		10	30		18	48	mV
	Conditions	V <sub>IN</sub> =4.5 to 12V, I <sub>o</sub> =1.0A			V <sub>IN</sub> =6 to 15V, I <sub>o</sub> =1.0A			V <sub>IN</sub> =10 to 20V, I <sub>o</sub> =1.0A			
Temperature Coefficient of Output Voltage	ΔV <sub>OLOAD</sub>		40	100		40	100		70	180	mV
	Conditions	V <sub>IN</sub> =5V, I <sub>o</sub> =0 to 1.5A			V <sub>IN</sub> =8V, I <sub>o</sub> =0 to 1.5A			V <sub>IN</sub> =12V, I <sub>o</sub> =0 to 1.5A			
Ripple Rejection	ΔV <sub>O</sub> /ΔT <sub>a</sub>		±0.5			±0.5			±1.0		mV/°C
	Conditions	V <sub>IN</sub> =5V, I <sub>o</sub> =5mA, T <sub>j</sub> =0 to 100°C			V <sub>IN</sub> =8V, I <sub>o</sub> =5mA, T <sub>j</sub> =0 to 100°C			V <sub>IN</sub> =12V, I <sub>o</sub> =5mA, T <sub>j</sub> =0 to 100°C			
Quiescent Circuit Current	R <sub>REJ</sub>		54			54			54		dB
	Conditions	V <sub>IN</sub> =5V, f=100 to 120Hz			V <sub>IN</sub> =8V, f=100 to 120Hz			V <sub>IN</sub> =12V, f=100 to 120Hz			
Overcurrent Protection Starting Current <sup>*4,6</sup>	I <sub>q</sub>		3	10		5	10		5	10	mA
	Conditions	V <sub>IN</sub> =5V, I <sub>o</sub> =0A			V <sub>IN</sub> =8V, I <sub>o</sub> =0A			V <sub>IN</sub> =12V, I <sub>o</sub> =0A			
V <sub>c</sub> Terminal <sup>*5</sup>	I <sub>s1</sub>	1.6			1.6			1.6			A
	Conditions	V <sub>IN</sub> =5V									
Control Voltage (Output ON)	I <sub>c</sub> IH	2.0			2.0			2.0			V
	I <sub>c</sub> IL			0.8			0.8			0.8	
	I <sub>c</sub> IH (Output ON)			20			20			20	μA
	Conditions	V <sub>c</sub> =2.7V									
Control Current (Output OFF)	I <sub>c</sub> IL			-0.3			-0.3			-0.3	mA
	Conditions	V <sub>c</sub> =0.4V									

\*1: "A" may be indicated to the right of the Sanken logo.

\*2: V<sub>IN(max)</sub> and I<sub>O(max)</sub> are restricted by the relation P<sub>D(max)</sub>=(V<sub>IN</sub>-V<sub>O</sub>)•I<sub>O</sub>=18(W).

\*3: Refer to the dropout voltage.(Refer to Setting DC Input Voltage on page 7.)

\*4: I<sub>s1</sub> is specified at -5(%) drop point of output voltage V<sub>O</sub> on the condition that V<sub>IN</sub>=V<sub>O</sub>+3V, I<sub>o</sub>=1A.

\*5: Output is ON even when output control terminal V<sub>c</sub> is open. Each input level is equivalent to LS-TTL. Therefore, it may be directly driven by an LS-TTL circuit.

\*6: A foldback type overcurrent protection circuit is built into the I<sub>c</sub> regulator (excluding SI-3033C). Therefore, avoid using it for the following applications as it may cause starting errors:

- (1) Constant current load (2) Plus/minus power (3) Series power (4) V<sub>O</sub> adjustment by raising ground voltage

■Electrical Characteristics

(Ta=25°C unless otherwise specified)

Parameter	Symbol	Ratings									Unit
		SI-3120C			SI-3150C			SI-3240C			
		min.	typ.	max.	min.	typ.	max.	min.	typ.	max.	
Input Voltage	V <sub>IN</sub>	13 <sup>3</sup>		30 <sup>2</sup>	16 <sup>3</sup>		30 <sup>2</sup>	25 <sup>3</sup>		40 <sup>2</sup>	V
Output Voltage	SI-3000C *1	11.52	12.00	12.48	14.40	15.00	15.60	23.04	24.00	24.96	V
	SI-3000CA	11.76	12.00	12.24	14.70	15.00	15.30	23.52	24.00	24.48	
Dropout Voltage	Conditions	V <sub>IN</sub> =15V, I <sub>O</sub> =1.0A			V <sub>IN</sub> =18V, I <sub>O</sub> =1.0A			V <sub>IN</sub> =27V, I <sub>O</sub> =1.0A			V
	V <sub>DIF</sub>			0.5			0.5			0.5	
	Conditions	I <sub>O</sub> ≤1.0A									
Line Regulation	ΔV <sub>OLINE</sub>		24	64		30	90		48	128	mV
	Conditions	V <sub>IN</sub> =13 to 25V, I <sub>O</sub> =1.0A			V <sub>IN</sub> =16 to 25V, I <sub>O</sub> =1.0A			V <sub>IN</sub> =25 to 38V, I <sub>O</sub> =1.0A			
Load Regulation	ΔV <sub>OLOAD</sub>		93	240		120	300		120	300	mV
	Conditions	V <sub>IN</sub> =15V, I <sub>O</sub> =0 to 1.5A			V <sub>IN</sub> =18V, I <sub>O</sub> =0 to 1.5A			V <sub>IN</sub> =27V, I <sub>O</sub> =0 to 1.5A			
Temperature Coefficient of Output Voltage	ΔV <sub>O</sub> /ΔT <sub>a</sub>		±1.5			±1.5			±2.5		mV/°C
	Conditions	V <sub>IN</sub> =15V, I <sub>O</sub> =5mA, T <sub>J</sub> =0 to 100°C			V <sub>IN</sub> =18V, I <sub>O</sub> =5mA, T <sub>J</sub> =0 to 100°C			V <sub>IN</sub> =27V, I <sub>O</sub> =5mA, T <sub>J</sub> =0 to 100°C			
Ripple Rejection	R <sub>REJ</sub>		54			54			54		dB
	Conditions	V <sub>IN</sub> =15V, f=100 to 120Hz			V <sub>IN</sub> =18V, f=100 to 120Hz			V <sub>IN</sub> =27V, f=100 to 120Hz			
Quiescent Circuit Current	I <sub>q</sub>		5	10		5	10		5	10	mA
	Conditions	V <sub>IN</sub> =15V, I <sub>O</sub> =0A			V <sub>IN</sub> =18V, I <sub>O</sub> =0A			V <sub>IN</sub> =27V, I <sub>O</sub> =0A			
Overcurrent Protection Starting Current <sup>*4,6</sup>	I <sub>S1</sub>	1.6			1.6			1.6			A
	Conditions	V <sub>IN</sub> =15V			V <sub>IN</sub> =18V			V <sub>IN</sub> =27V			
V <sub>c</sub> Terminal <sup>*5</sup>	Control Voltage (Output ON)	V <sub>c</sub> IH	2.0		2.0			2.0			V
	Control Voltage (Output OFF)	V <sub>c</sub> IL		0.8		0.8			0.8		
	Control Current (Output ON)	I <sub>c</sub> IH		20			20			20	μA
		Conditions	V <sub>c</sub> =2.7V								
Control Current (Output OFF)	I <sub>c</sub> IL			-0.3		-0.3				-0.3	mA
	Conditions	V <sub>c</sub> =0.4V									

\*1: "A" may be indicated to the right of the Sanken logo.

\*2: V<sub>IN(max)</sub> and I<sub>O(max)</sub> are restricted by the relation P<sub>D(max)</sub>=(V<sub>IN</sub>-V<sub>O</sub>)•I<sub>O</sub>=18(W).

\*3: Refer to the dropout voltage.(Refer to Setting DC Input Voltage on page 7.)

\*4: I<sub>S1</sub> is specified at -5(%) drop point of output voltage V<sub>O</sub> on the condition that V<sub>IN</sub>=V<sub>O</sub>+3V, I<sub>O</sub>=1A.

\*5: Output is ON even when output control terminal V<sub>c</sub> is open. Each input level is equivalent to LS-TTL. Therefore, it may be directly driven by an LS-TTL circuit.

\*6: A foldback type overcurrent protection circuit is built into the I<sub>c</sub> regulator. Therefore, avoid using it for the following applications as it may cause starting errors:

- (1) Constant current load (2) Plus/minus power (3) Series power (4) V<sub>O</sub> adjustment by raising ground voltage

■External Dimensions

(unit:mm)

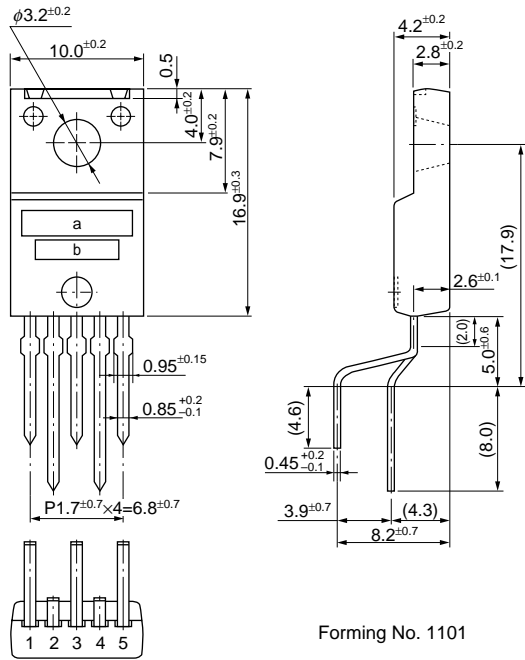

a. Part Number  
b. Lot Number

Pin Arrangement

- ① GND
- ② V<sub>c</sub>
- ③ V<sub>o</sub>
- ④ V<sub>os</sub>
- ⑤ V<sub>IN</sub>

Plastic Mold Package Type  
Flammability: UL94V-0  
Weight: Approx. 2.3g

■Block Diagram

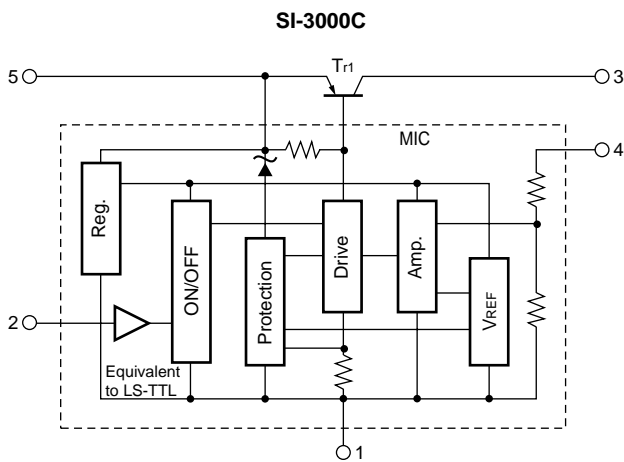

■Standard External Circuit

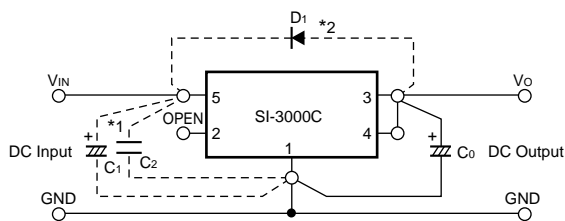

C<sub>0</sub> : Output capacitor (47 to 100μF)

\*1 C<sub>1</sub> } Oscillation prevention capacitor

C<sub>2</sub> } (C<sub>1</sub>: Approx. 47μF, C<sub>2</sub>: 0.33μF)

These capacitors are required if the input line is inductive and in the case of long wiring. Tantalum capacitors are recommended for C<sub>1</sub> and C<sub>0</sub>, particularly at low temperatures.

\*2 D<sub>1</sub> : Protection diode

This diode is required for protection against reverse biasing of the input and output. Sanken EU2Z is recommended.

## ■ $T_a$ - $P_D$ Characteristics

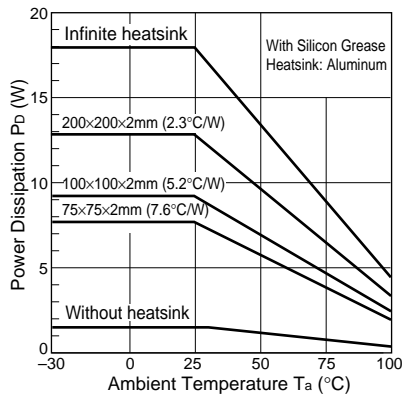

$$P_D = I_O \cdot [V_{IN(\text{mean})} - V_O]$$

## External Variable Output Voltage Circuit

### 1. Variable output voltage with a single external resistor

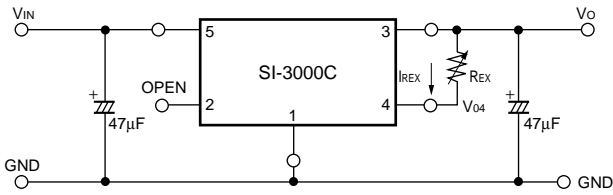

The output voltage may be increased by inserting resistor  $R_{EX}$  between terminals No.4 (sensing terminal) and No.3 (output terminal). The current  $I_{REX}$  flowing into terminal No.4 is 1mA (typ.)(SI-3033C:0.43mA (typ.)), therefore the adjusted output voltage  $V_{OUT}$  is:

$$V_O = V_{04} + I_{REX} \cdot R_{EX} \quad *V_{04}: \text{output voltage of SI-3000C series}$$

However, the internal resistor (between terminals No. 4 and No.1) is a semiconductor resistor, which has approximately thermal characteristics of +0.2%/°C.

It is important to keep the thermal characteristics in mind when adjusting the output voltage.

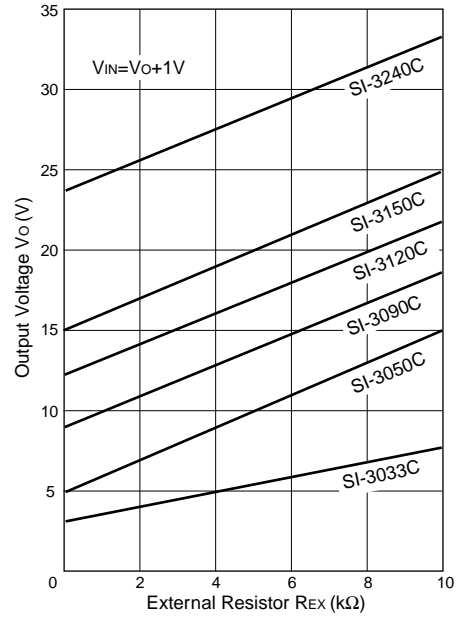

### 2. Variable output voltage with two external resistors

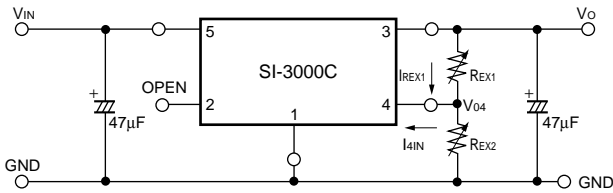

The output voltage may be increased by inserting resistors  $R_{EX1}$  between terminals No.4 (sensing terminal) and No.3 (output terminal) and  $R_{EX2}$  between terminals No.4 and No.1 (ground terminal).

The current  $I_{4IN}$  flowing into terminal No.4 is 1mA (typ.)(SI-3033C: 0.43mA (typ.)) so the thermal characteristics may be improved compared to the method shown in 1 by setting the external current  $I_{REX1}$  at approximately 5 times the value of  $I_{4IN}$  (stability coefficient  $S=5$ ).

The adjusted output voltage  $V_{OUT}$  in this case is:

$$\begin{cases} V_O = V_{04} + R_{EX1} \cdot I_{REX1} \\ I_{REX1} = S \cdot I_{4IN} \end{cases}$$

The value of the external resistors may be obtained as follows:

$$R_{EX1} = \frac{V_O - V_{04}}{S \cdot I_{4IN}}, \quad R_{EX2} = \frac{V_{04}}{(S-1) \cdot I_{4IN}}$$

\* $V_{04}$ : Output voltage of SI-3000C series

S: Stability coefficient of  $I_{4IN}$  (may be set to any value)

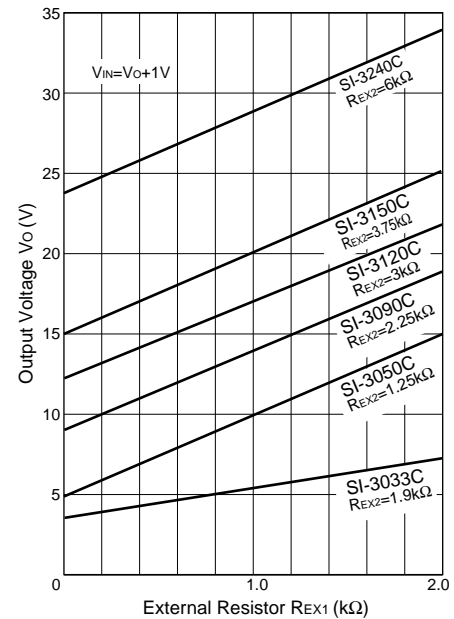

Note: In the SI-3000C series, the output voltage increase can be adjusted as mentioned above. However, when the rise is set to approximately 10V compared to output voltage  $V_{04}$ , the necessary output current may not be obtained due to the S.O.A. protection circuit in the SI-3000C series.

■Typical Characteristics

( $T_a=25^\circ\text{C}$ )

Io vs. VDIF Characteristics

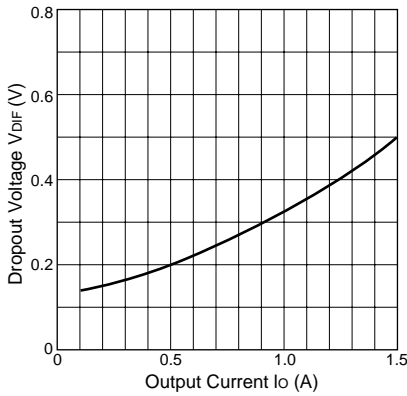

Temperature Coefficient of Output Voltage(SI-3050C)

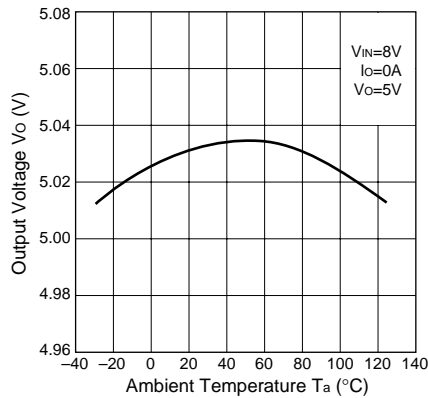

Circuit Current(SI-3050C)

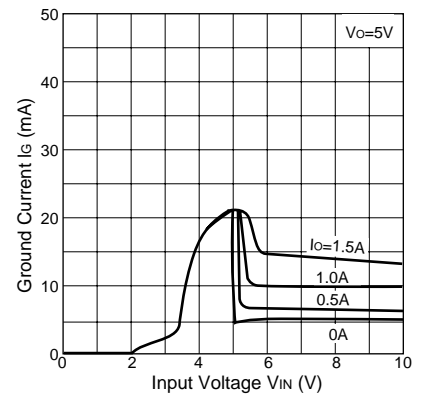

Output Voltage(SI-3033C)

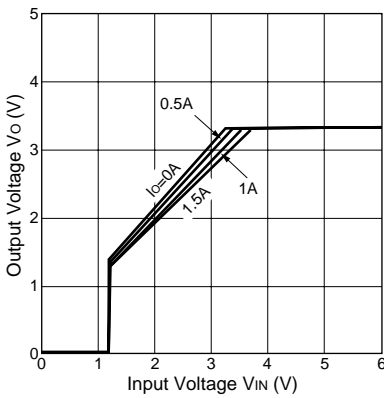

Output Voltage(SI-3050C)

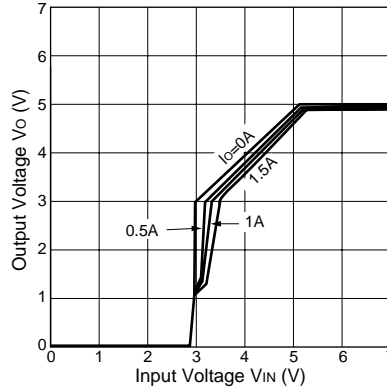

Output Voltage(SI-3240C)

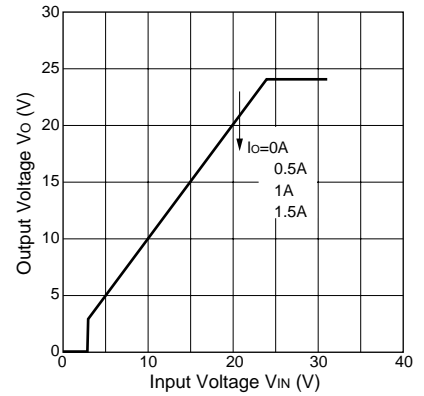

Overcurrent Protection Characteristics(SI-3033C)

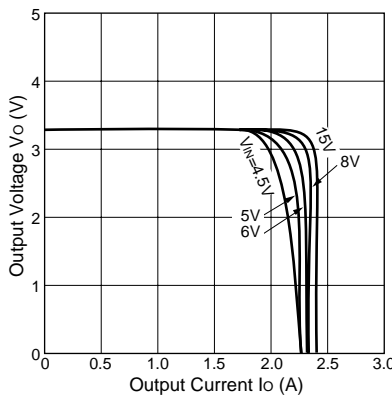

Overcurrent Protection Characteristics(SI-3050C)

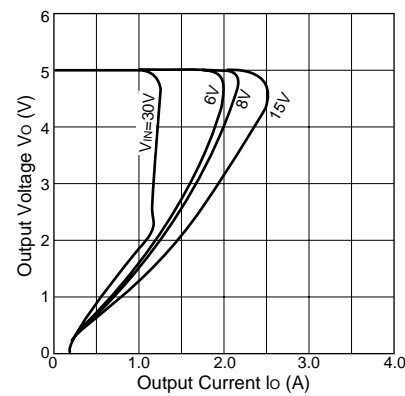

Overcurrent Protection Characteristics(SI-3240C)

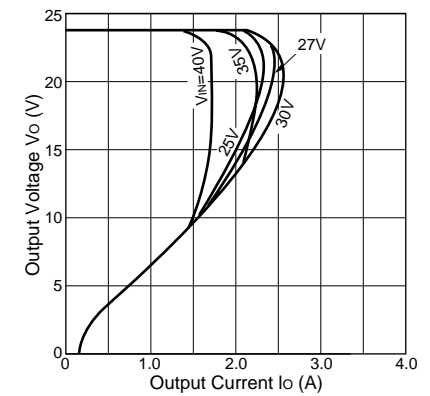

ON/OFF Control Characteristics(SI-3050C)

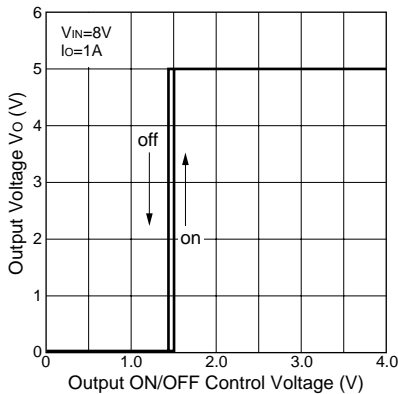

Thermal Protection Characteristics(SI-3050C)

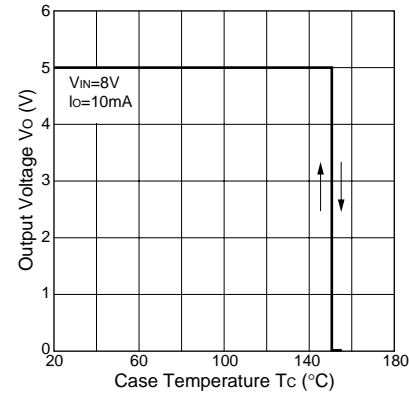

**Note on Thermal Protection:**

The thermal protection circuit is intended for protection against heat during instantaneous short-circuiting. Its operation is not guaranteed for continuous heating condition such as short-circuiting over extended periods of time.