

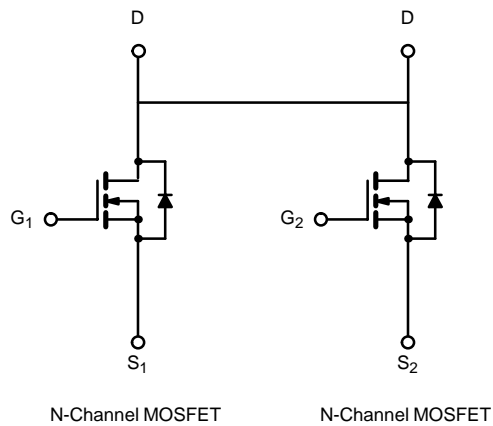

N-Channel 2.5-V (G-S) Battery Switch

PRODUCT SUMMARY		
V _{DS} (V)	R _{DS(ON)} (Ω)	I _D (A)
20	0.022 @ V _{GS} = 4.5 V	± 6.5
	0.030 @ V _{GS} = 2.5 V	± 5.5

2.5-V Rated

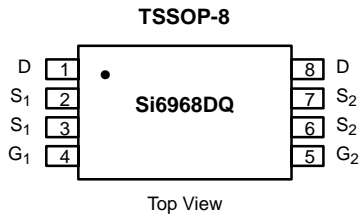

ABSOLUTE MAXIMUM RATINGS (T _A = 25 °C UNLESS OTHERWISE NOTED)			
PARAMETER	SYMBOL	LIMIT	UNIT
Drain-Source Voltage	V _{DS}	20	V
Gate-Source Voltage	V _{GS}	± 12	
Continuous Drain Current (T _J = 150 °C) ^{A, B}	I _D	T _A = 25 °C	A
		T _A = 70 °C	
Pulsed Drain Current	I _{DM}	± 30	A
Continuous Source Current (Diode Conduction) ^{A, B}	I _S	1.5	
Maximum Power Dissipation ^{A, B}	P _D	T _A = 25 °C	W
		T _A = 70 °C	
Operating Junction and Storage Temperature Range	T _J , T _{stg}	-55 to 150	°C

THERMAL RESISTANCE RATINGS				
PARAMETER	SYMBOL	TYPICAL	MAXIMUM	UNIT
Maximum Junction-to-Ambient ^A	t ≤ 10 sec	R _{thJA}	83	°C/W
	Steady State	R _{thJA}	85	

Notes
A. Surface Mounted on FR4 Board.
B. t ≤ 10 sec.

Updates to this data sheet may be obtained via facsimile by calling Siliconix FaxBack, 1-408-970-5600. Please request FaxBack document #70757.

SPECIFICATIONS (T_J = 25 °C UNLESS OTHERWISE NOTED)

PARAMETER	SYMBOL	TEST CONDITION	MIN	TYP	MAX	UNIT
STATIC						
Gate Threshold Voltage	V _{GS(th)}	V _{DS} = V _{GS} , I _D = 250 μA	0.6			V
Gate-Body Leakage	I _{GSS}	V _{DS} = 0 V, V _{GS} = ±12 V			±100	nA
Zero Gate Voltage Drain Current	I _{DSS}	V _{DS} = 20 V, V _{GS} = 0 V			1	μA
		V _{DS} = 20 V, V _{GS} = 0 V, T _J = 70 °C			5	
On-State Drain Current ^A	I _{D(on)}	V _{DS} ≥ 5 V, V _{GS} = 4.5 V	30			A
Drain-Source On-State Resistance ^A	r _{DS(on)}	V _{GS} = 4.5 V, I _D = 6.5 A		0.017	0.022	Ω
		V _{GS} = 2.5 V, I _D = 5.5 A		0.022	0.030	
Forward Transconductance ^A	g _{fs}	V _{DS} = 10 V, I _D = 6.5 A		30		S
Diode Forward Voltage ^A	V _{SD}	I _S = 1.5 A, V _{GS} = 0 V		0.66	1.2	V
DYNAMIC^B						
Total Gate Charge	Q _g	V _{DS} = 10 V, V _{GS} = 10 V, I _D = 6.5 A		16	30	nC
Gate-Source Charge	Q _{gs}			3.4		
Gate-Drain Charge	Q _{gd}			4.0		
Turn-On Delay Time	t _{d(on)}	V _{DD} = 10 V, R _L = 10 Ω I _D ≅ 1 A, V _{GEN} = 4.5 V, R _G = 6 Ω		20	40	ns
Rise Time	t _r			48	80	
Turn-Off Delay Time	t _{d(off)}			90	180	
Fall Time	t _f			55	110	
Source-Drain Reverse Recovery Time	t _{rr}		I _F = 1.5 A, di/dt = 100 A/μs		40	

Notes

- A. Pulse test; pulse width ≤ 300 μs, duty cycle ≤ 2%.
 B. Guaranteed by design, not subject to production testing.



TYPICAL CHARACTERISTICS (25°C UNLESS OTHERWISE NOTED)

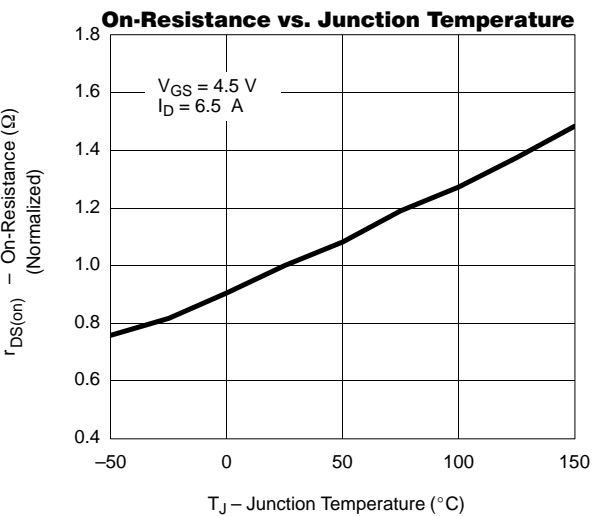
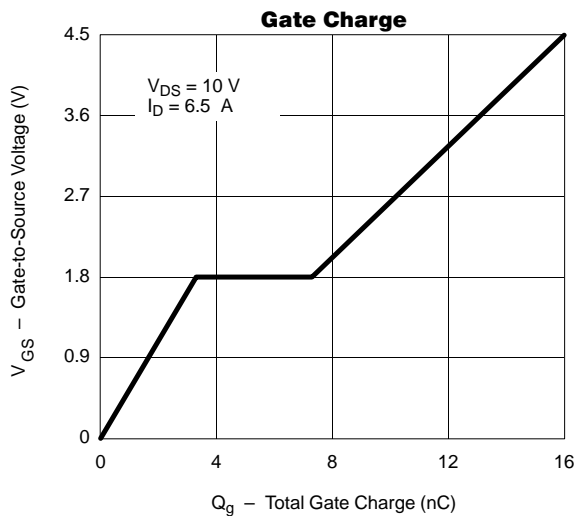
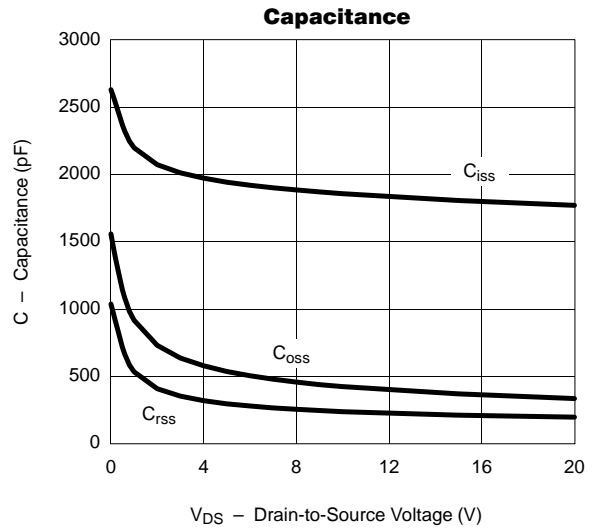
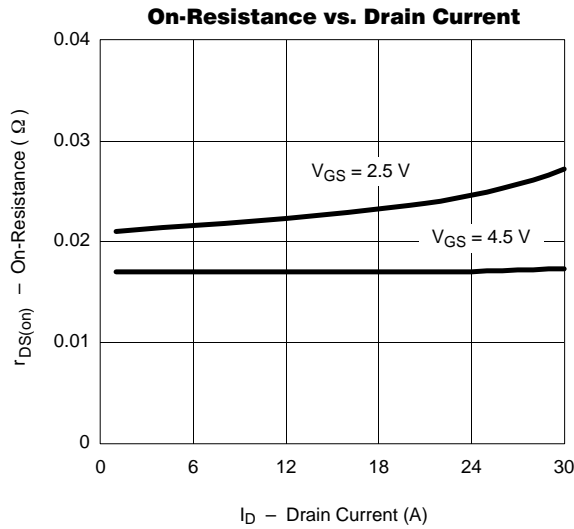
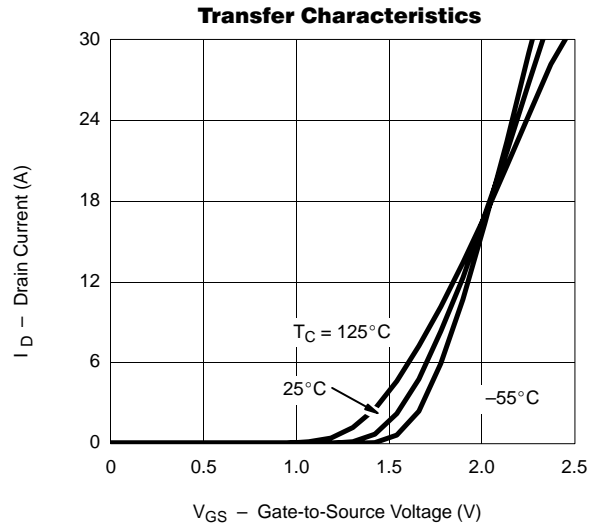
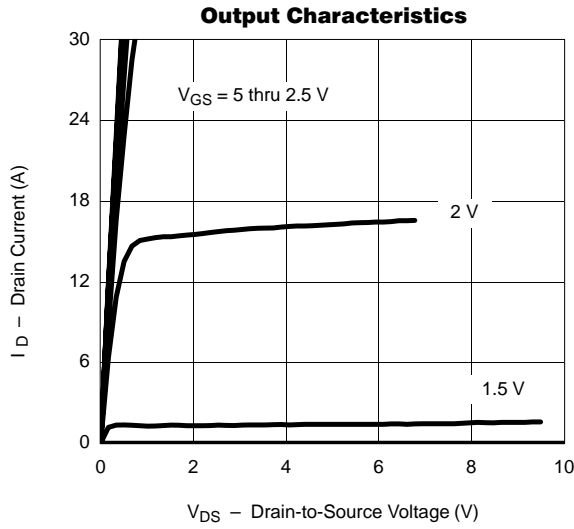



TYPICAL CHARACTERISTICS (25°C UNLESS NOTED)

