



N-Channel 20-V (D-S) MOSFET

PRODUCT SUMMARY		
V_{DS} (V)	$r_{DS(on)}$ (Ω)	I_D (A)
20	0.0055 @ $V_{GS} = 10$ V	20
	0.0085 @ $V_{GS} = 4.5$ V	16

FEATURES

- TrenchFET® Power MOSFET
- Low $r_{DS} \times Q_g$ Figure of Merit
- Optimized For High Frequency Conversion

APPLICATIONS

- Low-Side MOSFET in Synchronous Buck DC/DC Converters in Desktops
- Low Output Voltage Synchronous Rectifier

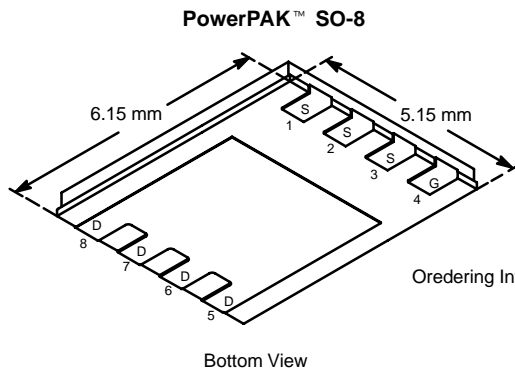

Ordering Information: Si7368DP-T1

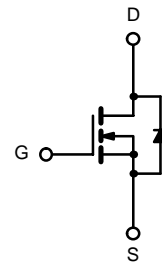

N-Channel MOSFET

ABSOLUTE MAXIMUM RATINGS ($T_A = 25^\circ\text{C}$ UNLESS OTHERWISE NOTED)					
Parameter	Symbol	10 secs	Steady State	Unit	
Drain-Source Voltage	V_{DS}	20		V	
Gate-Source Voltage	V_{GS}	± 16			
Continuous Drain Current ($T_J = 150^\circ\text{C}$) ^a	I_D	$T_A = 25^\circ\text{C}$	20	13	A
		$T_A = 70^\circ\text{C}$	17	10	
Pulsed Drain Current (10 μs Pulse Width)	I_{DM}	50			
Continuous Source Current (Diode Conduction) ^a	I_S	4.1	1.4		
Maximum Power Dissipation ^a	P_D	$T_A = 25^\circ\text{C}$	5	1.7	W
		$T_A = 70^\circ\text{C}$	3.2	1.1	
Operating Junction and Storage Temperature Range	T_J, T_{stg}	-55 to 150		$^\circ\text{C}$	

THERMAL RESISTANCE RATINGS					
Parameter	Symbol	Typical	Maximum	Unit	
Maximum Junction-to-Ambient ^a	R_{thJA}	$t \leq 10$ sec	20	25	$^\circ\text{C/W}$
		Steady State	53	70	
Maximum Junction-to-Case (Drain)	R_{thJC}	3.4	4.5		

Notes

a. Surface Mounted on 1" x 1" FR4 Board.

SPECIFICATIONS (T_J = 25 °C UNLESS OTHERWISE NOTED)

Parameter	Symbol	Test Condition	Min	Typ	Max	Unit
Static						
Gate Threshold Voltage	V _{GS(th)}	V _{DS} = V _{GS} , I _D = 250 μA	0.7		1.8	V
Gate-Body Leakage	I _{GSS}	V _{DS} = 0 V, V _{GS} = ± 16 V			± 100	nA
Zero Gate Voltage Drain Current	I _{DSS}	V _{DS} = 16 V, V _{GS} = 0 V			1	μA
		V _{DS} = 16 V, V _{GS} = 0 V, T _J = 55 °C			5	
On-State Drain Current ^a	I _{D(on)}	V _{DS} ≥ 5 V, V _{GS} = 10 V	30			A
Drain-Source On-State Resistance ^a	r _{DS(on)}	V _{GS} = 10 V, I _D = 20 A		0.0043	0.0055	Ω
		V _{GS} = 4.5 V, I _D = 16 A		0.0065	0.0085	
Forward Transconductance ^a	g _{fs}	V _{DS} = 6 V, I _D = 20 A		48		S
Diode Forward Voltage ^a	V _{SD}	I _S = 4.5 A, V _{GS} = 0 V		0.7	1.1	V
Dynamic^b						
Total Gate Charge	Q _g	V _{DS} = 10 V, V _{GS} = 4.5 V, I _D = 20 A		17	25	nC
Gate-Source Charge	Q _{gs}			4.5		
Gate-Drain Charge	Q _{gd}			4.5		
Gate Resistance	R _g			1.5		Ω
Turn-On Delay Time	t _{d(on)}	V _{DD} = 10 V, R _L = 10 Ω I _D ≅ 1 A, V _{GEN} = 10 V, R _G = 6 Ω		22	35	ns
Rise Time	t _r			20	30	
Turn-Off Delay Time	t _{d(off)}			65	100	
Fall Time	t _f			17	30	
Source-Drain Reverse Recovery Time	t _{rr}	I _F = 4.1 A, di/dt = 100 A/μs		40	80	

Notes

- a. Pulse test; pulse width ≤ 300 μs, duty cycle ≤ 2%.
b. Guaranteed by design, not subject to production testing.

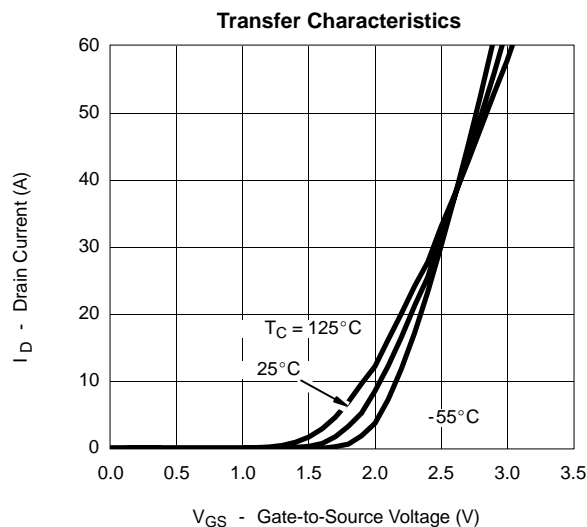
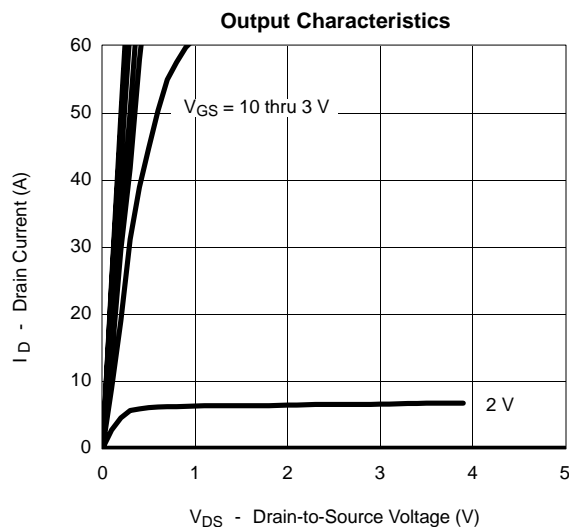
TYPICAL CHARACTERISTICS (25 °C UNLESS NOTED)



TYPICAL CHARACTERISTICS (25°C UNLESS NOTED)

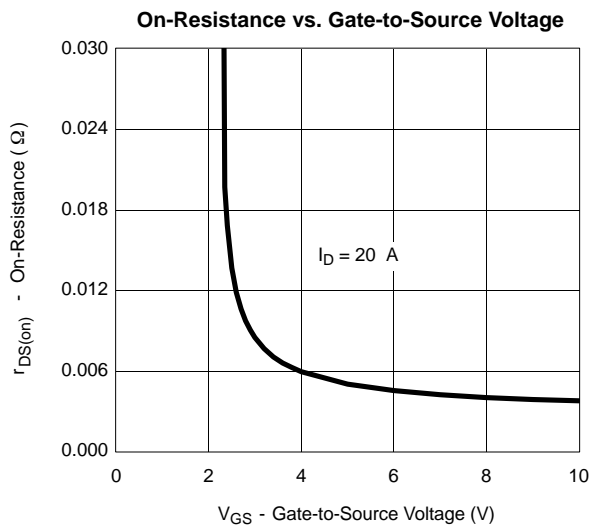
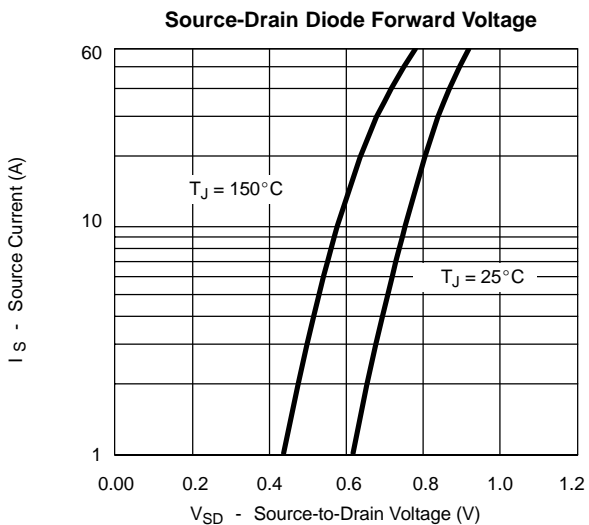
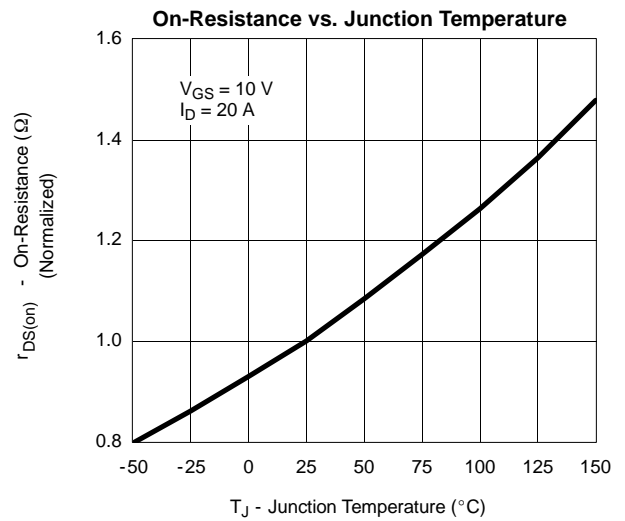
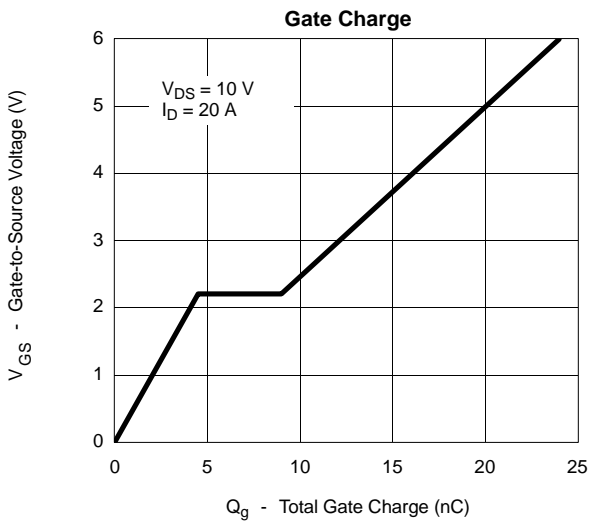
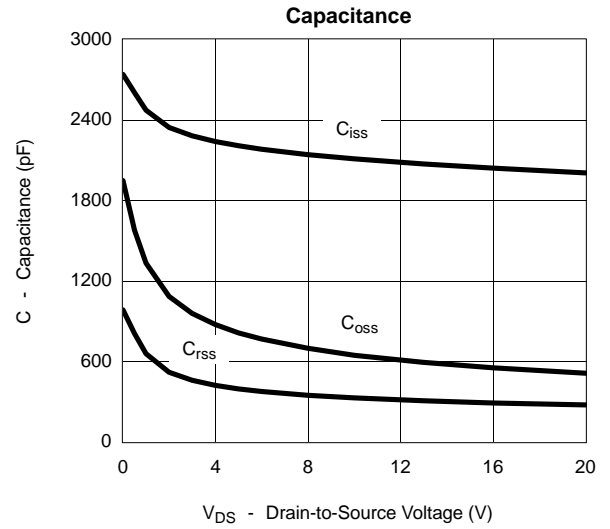
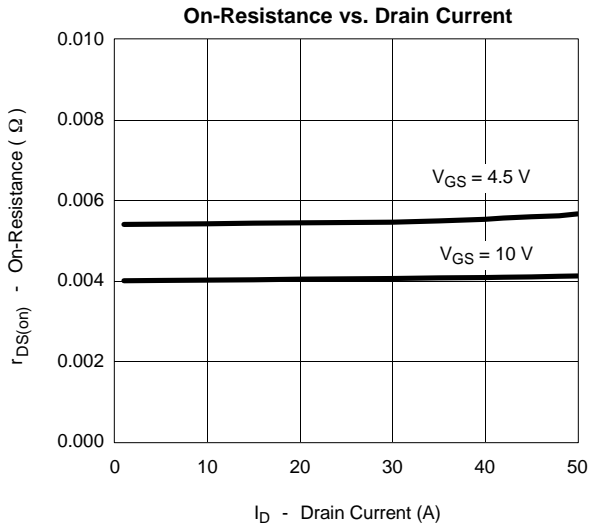

TYPICAL CHARACTERISTICS (25°C UNLESS NOTED)

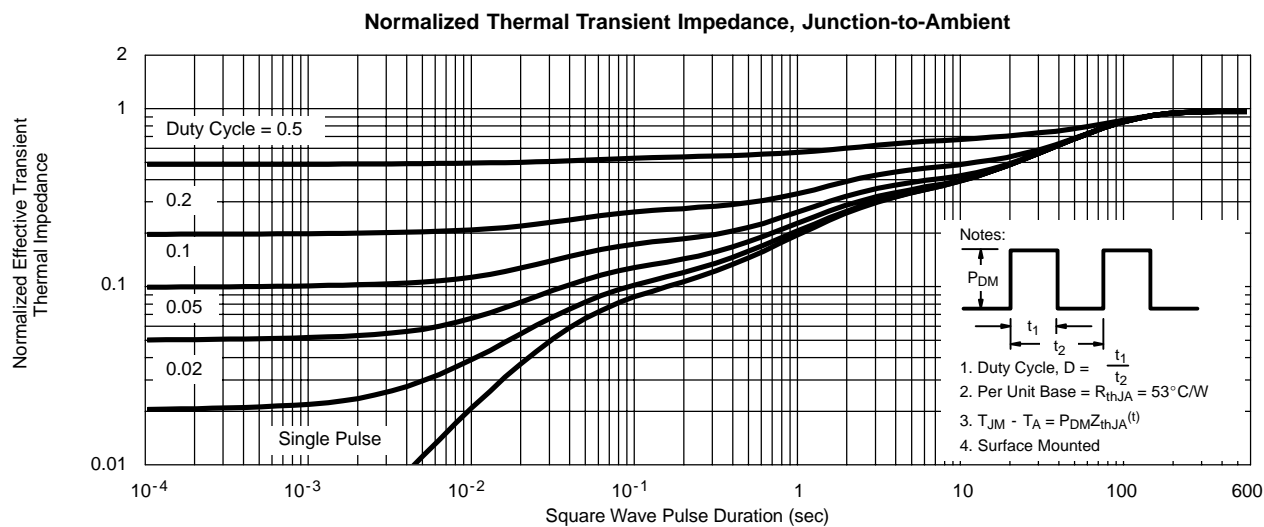
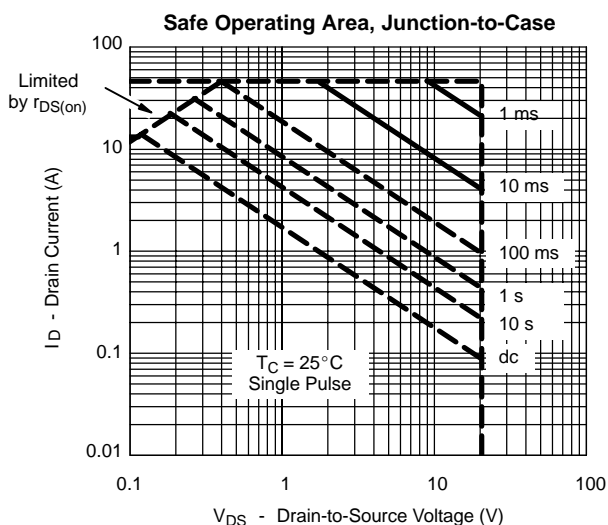
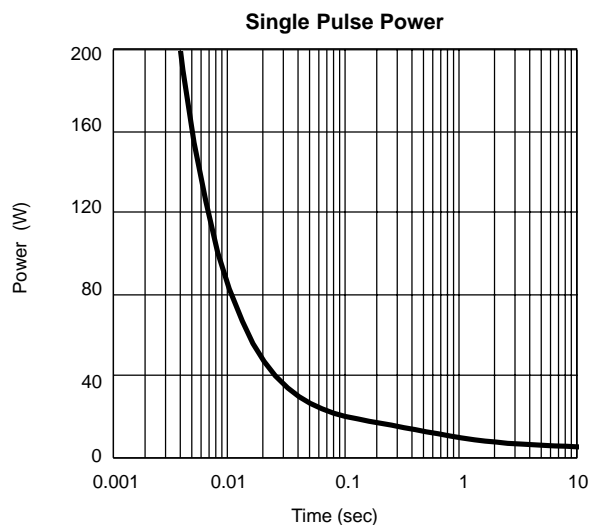
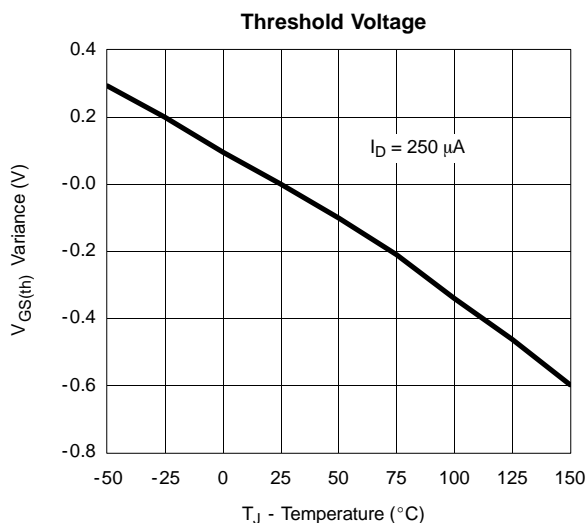



TYPICAL CHARACTERISTICS (25°C UNLESS NOTED)

