



1 INTRODUCTION

SN66016B is a 16 seconds single chip 4-channel voice synthesizer IC that contains I/O pins and a tiny controller. By programming through the tiny controller, users' applications including section combination, trigger modes, output status, high performance melody, multiple voices, and other logic functions can be implemented.

2 FEATURES

- ◆ Single power supply 2.4V – 5.1V
- ◆ Built in a tiny controller
- ◆ 16 seconds voice capacity are provided
- ◆ One 4-bit input port, two 4-bit I/O ports and one 4-bit output port are provided
- ◆ 128*4 bits RAM are provided
- ◆ Maximum 52k program ROM is provided
- ◆ Readable ROM code data
- ◆ Built in a high quality speech synthesizer
- ◆ Four independent voice channels
- ◆ Adaptive playing speed from 4k-40kHz is provided for all 4 channels individually
- ◆ Automatic repetition for every channel
- ◆ A 6-bit*8-bit Multiplier is embed to modulate the volume of synthesized voices
- ◆ Two digital mixers (with saturation control) are provided
- ◆ Two 8-bit current output DA converters (Channel 1 + Channel 2 → DA1, Channel 3 + Channel 4 → DA2)
- ◆ System clock: 2M Hz (RC-type or Crystal Option)
- ◆ Low Voltage Reset

3 Block Diagram

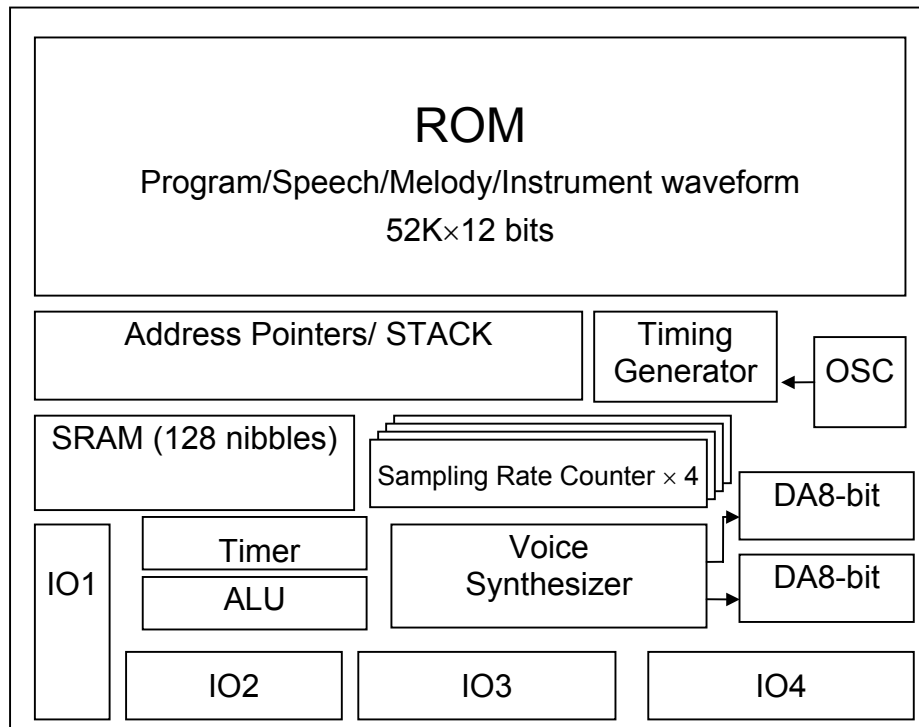

4 PIN ASSIGNMENT

Symbol	I/O	Function Description
P13, P12, P11, P10	I	Bit3 ~ Bit0 of input port 1
P23, P22, P21, P20	I/O	Bit3 ~ Bit0 of I/O port 2
P33, P32, P31, P30	I/O	Bit3 ~ Bit0 of I/O port 3
P43, P42, P41, P40	O	Bit3 ~ Bit0 of output port 4
VDD	I	Positive power supply
GND	I	Negative power supply
OSC/XIN	I	Oscillator / Crystal In
XOUT	O	Crystal Out
CKSEL	I	Clock type select 'L' or floating → RC oscillator 'H' → Crystal
VO1	O	D/A current output, for channel 1 and 2
VO2	O	D/A current output, for channel 3 and 4

5 FUNCTION DESCRIPTIONS

5.1. Oscillator

SN66016B accepts crystal oscillator / ceramic resonator or RC type oscillator (selected by pin CKSEL) for system clock. The typical circuit diagrams for oscillator are listed as follows.

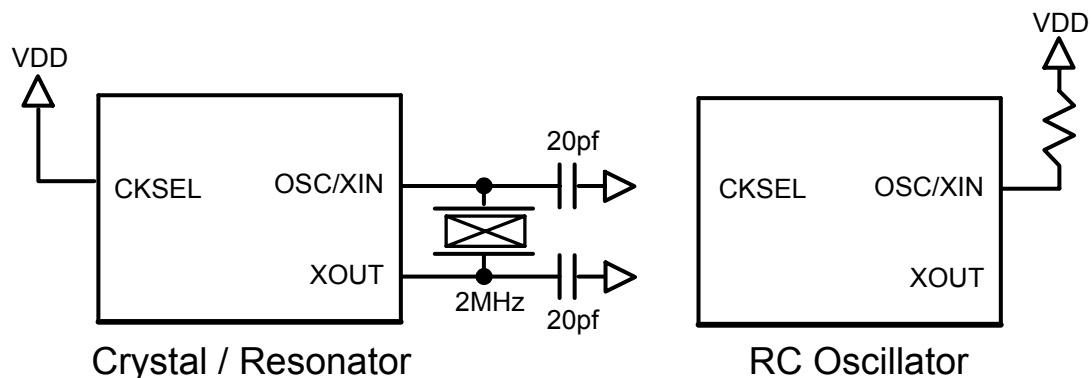

5.2. ROM

SN66016B contains 52K word (12-bit) internal ROM. Program, voices, melodies, data, and instrument waveforms share the same ROM with the others.

5.3. RAM

SN66016B contains 128 nibble RAM. The 128 nibble RAM is separated into two pages (page 0 and page 1). An implicit page indicator is utilized to specify page address. Two instructions, PAGE0 and PAGE1, can switch the page indicator. All 64 nibbles of each page can be accessed by direct mode (to specify M0 ~ M63 in the data transfer type instructions.)

5.4. Power Down Mode

“End” instruction will let SN66016B enter power down mode and consumer very little amount of current. (<2uA @VDD=3V and <5uA @VDD=5V) After SN66016B enters power down mode, any valid data transition (L→H or H→L) occurring on any input ports or IO ports (P1, P2, and P3) lead SN66016B back to normal operation mode.

5.5. Sampling Rate Counters

4 independent sampling rate counters are dedicated to 4 individual voice channels to play voices with different playing rates. The playing rate is programmable from 4KHz to 40KHz. The resolution of sampling period of each sampling rate counter is 0.25 uS. This feature helps SN66016B play sounds with accurate pitches in the case of music instrument synthesis.

5.6. Auto repetition

Auto repetition function helps SN66016B realize a “looping” sound automatically by hardware without any software effort. Auto repetition function is a very useful mechanism to implement “Sustain” sound in instrument synthesis. All 4 channels are equipped with this function. Arbitrary lengths of looping sound are accepted by SN66016B.

5.7. I/O Ports

P1 is a 4-bit input port, P2/P3 are two 4-bit I/O ports and P4 is a 4-bit output port. Any bit of P2 and P3 can be programmed to be input or output individually. Any valid data transition (H→ L or L→H) of P1, P2 and P3 can reactivate the chip when it is in power-down stage.

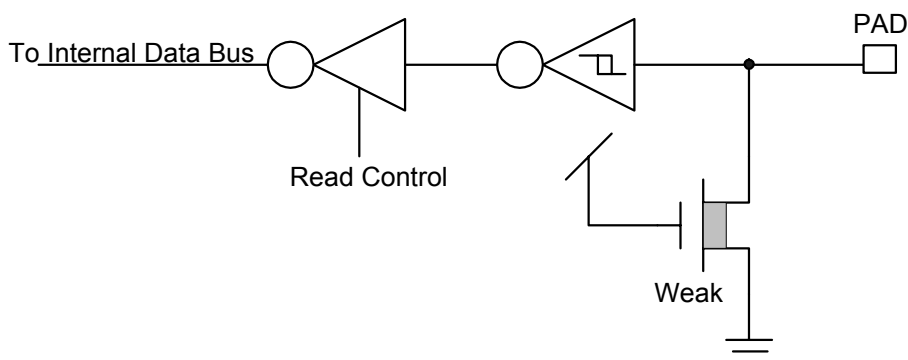

Input Port Configuration (P10~P13)

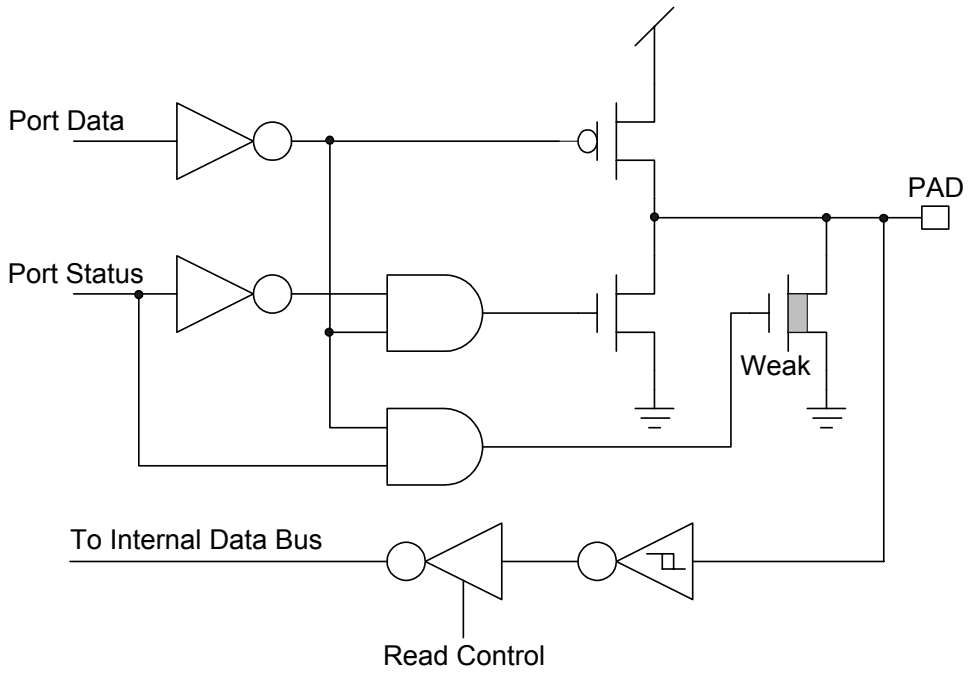

I/O Port Configuration (P20~P23, P30~P33)

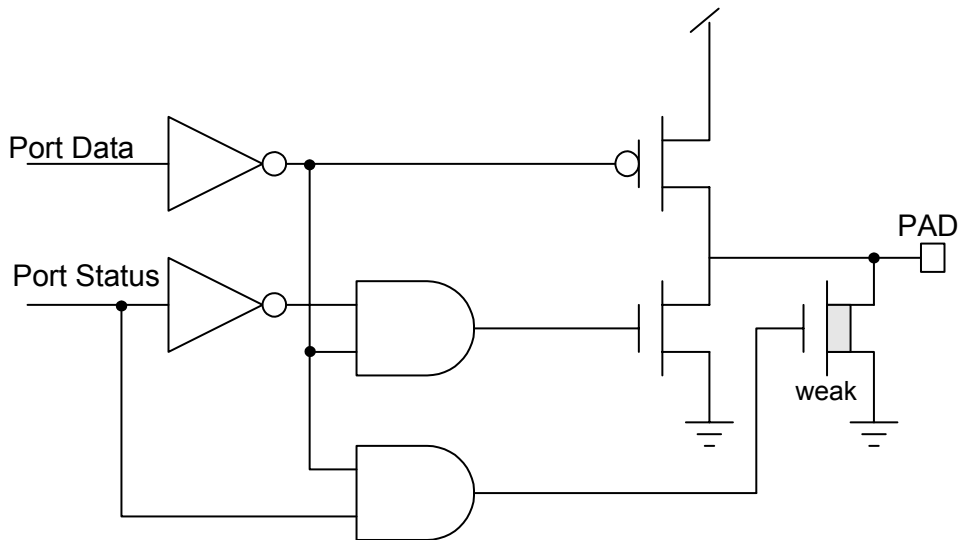

Output Port Configuration (P40~P43)

Note: All weak N-MOS's can serve as pull-low resistors.

5.8. IR Function

P33 can be modulated with 42KHz square wave before sent out to P33 pin. The IR signal can be achieved by this modulated signal.

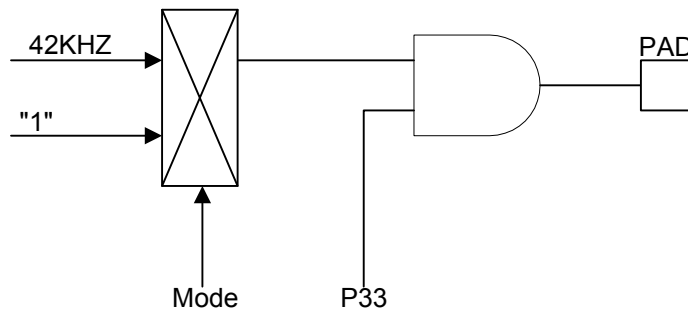

5.9. 2 8-bit DAC

Two 8-bit current type digital-to-analog converters are built-in SN66016B. The relationship between input digital data and output analog current signal is listed in the following table. Also, the recommended application circuit is illustrated as follows.

Input data	Typical value of output current (mA)
0	0
1	3/255
...	
N	$n \cdot (3/255)$
...	
255	3

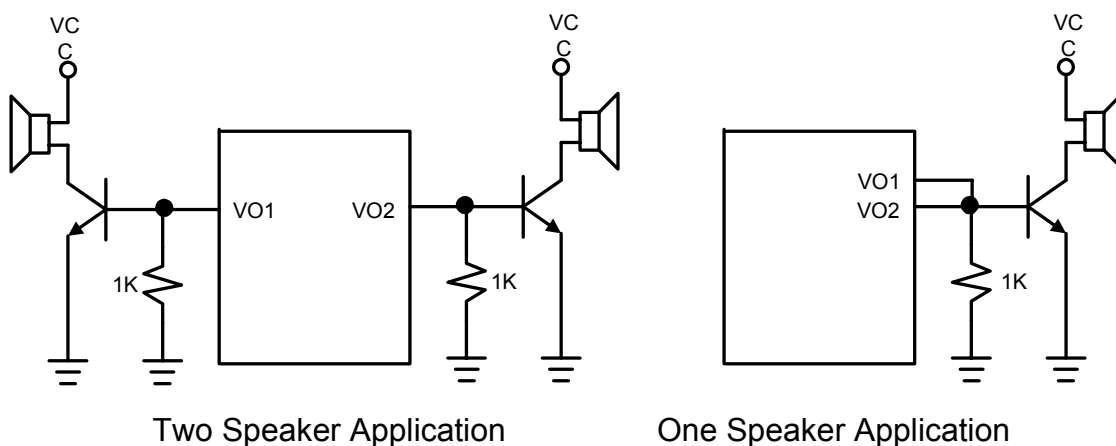



6 ABSOLUTE MAXIMUM RATING

Items	Symbol	Min	Max	Unit.
Supply Voltage	V_{DD-V}	-0.3	6.0	V
Input Voltage	V_{IN}	$V_{SS}-0.3$	$V_{DD}+0.3$	V
Operating Temperature	T_{OP}	0	55.0	°C
Storage Temperature	T_{STG}	-55.0	125.0	°C

7 ELECTRICAL CHARACTERISTICS

Item	Sym.	Min.	Typ.	Max.	Unit	Condition
Operating Voltage	V_{DD}	2.4	3.0	5.1	V	
Standby Current	I_{SBY}	-	2	3	μA	$V_{DD}=3V$
		-	5	7		$V_{DD}=5V$
Operating Current	I_{OPR}	-	350	400	μA	$V_{DD}=3V$, no load
		-	1.3	2	mA	$V_{DD}=5V$, no load
Input Current of P1	I_{IH}	-	3	10	μA	$V_{DD}=3V$, $V_{IN}=3V$
		-	10	30		$V_{DD}=5V$, $V_{IN}=5V$
Drive Current of P2, P3, P4	I_{OD}	1.5	2	-	mA	$V_{DD}=3V$, $V_O=2.6V$
		3	5	-		$V_{DD}=5V$, $V_O=4.2V$
Sink Current of P2, P3, P4	I_{OS}	2	3	-	mA	$V_{DD}=3V$, $V_O=0.4V$
		6	8	-		$V_{DD}=5V$, $V_O=0.8V$
VO1/VO2 Output Current	I_{VO}	2	3	4	mA	$V_{DD}=3V$, $V_O=0.7V$
		2	3	4		$V_{DD}=5V$, $V_O=0.7V$
Oscillation Freq.	F_{OSC}	-	2	-	MHz	$V_{DD}=3V$, ROSC=330K
IR Carrier Frequency	Fir	-	41.7	-	KHz	Fosc=2MHz

8 APPLICATION CIRCUIT

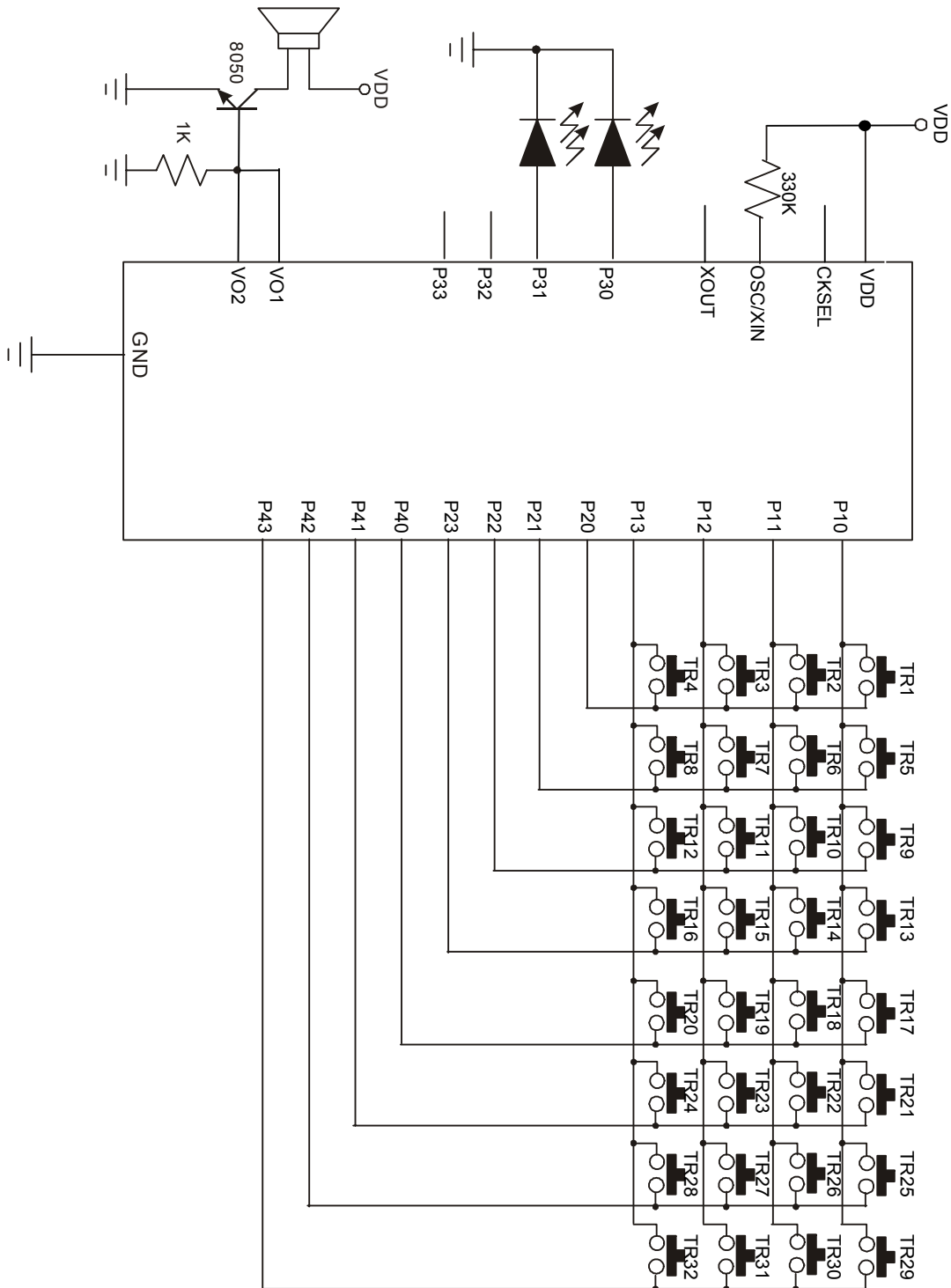

Crystal Oscillator
One Speaker Output
32 Scan Keys



SN66016B

4-Channel Speech Controller

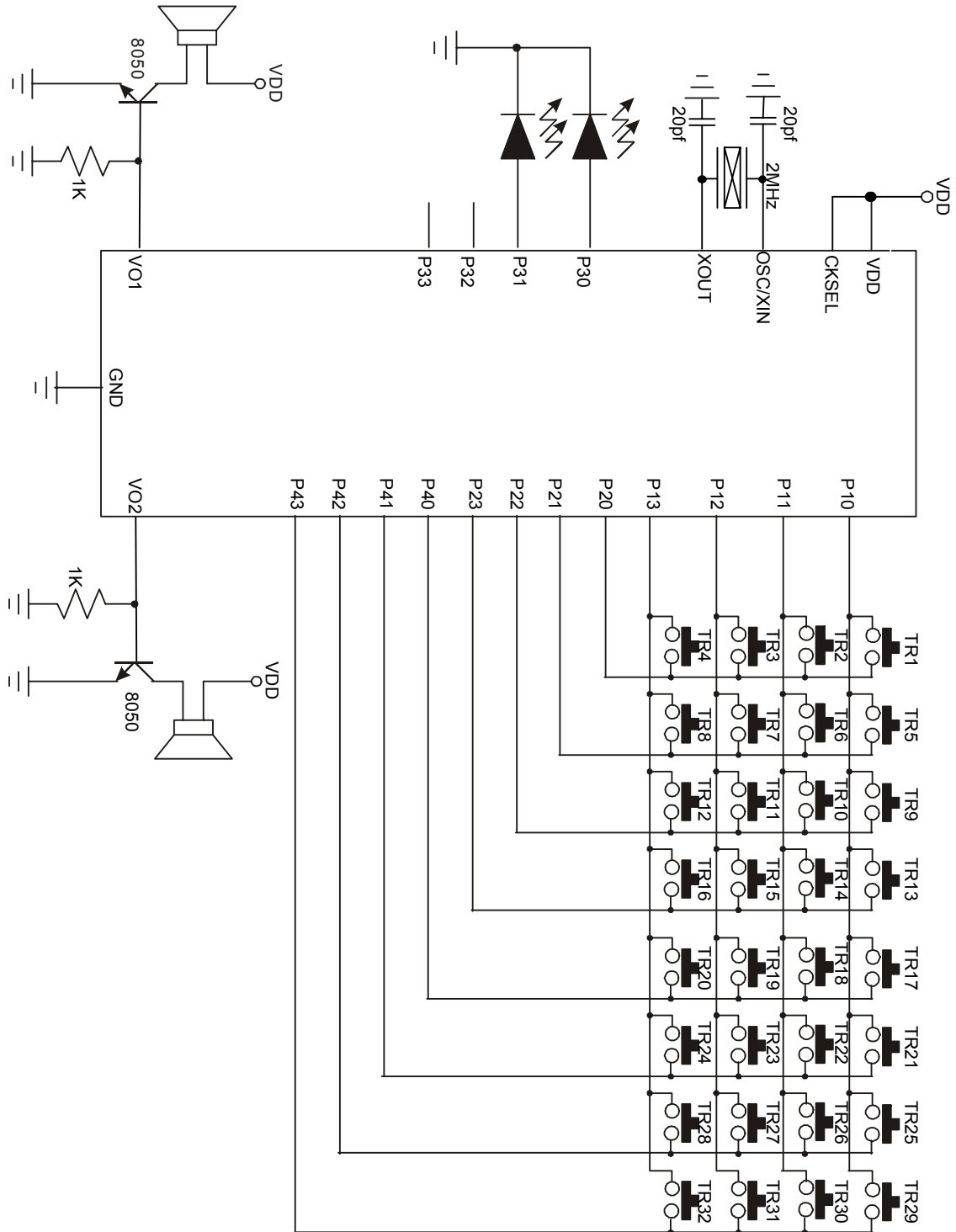

Crystal Oscillator
Two Speaker Output
32 Scan Keys

9 BONDING PAD

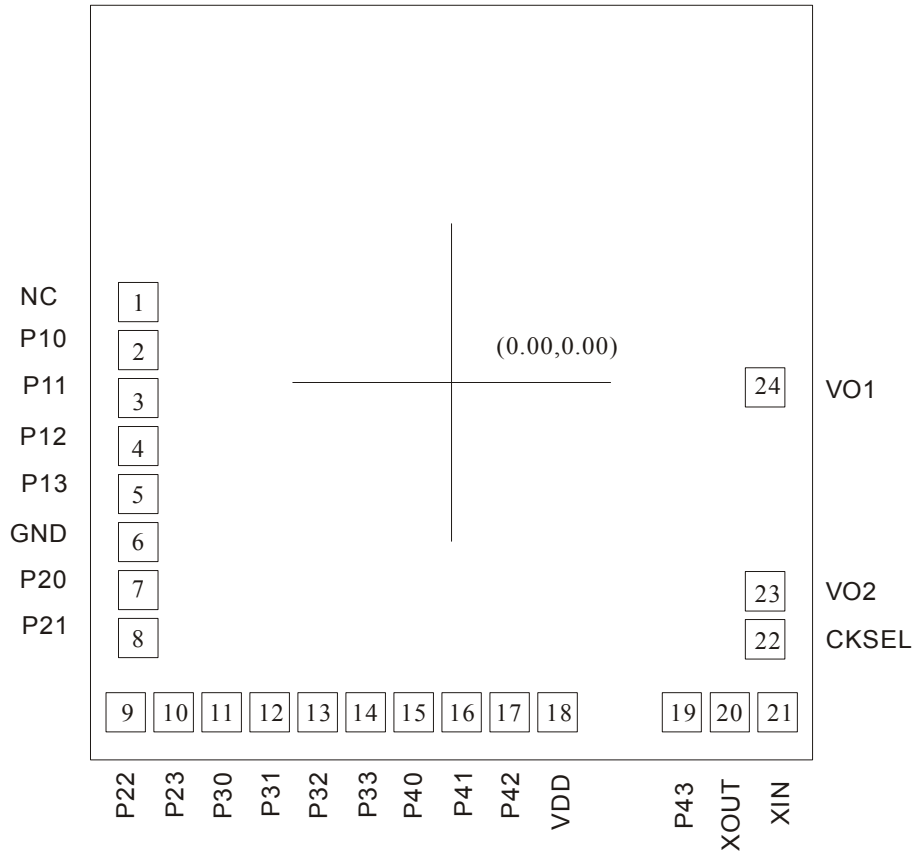

SN66016B

Note: The substrate MUST be connected to GND in PCB layout.

10 DISCLAIMER

The information appearing in SONiX web pages (“this publication”) is believed to be accurate.

However, this publication could contain technical inaccuracies or typographical errors. The reader should not assume that this publication is error-free or that it will be suitable for any particular purpose. SONiX makes no warranty, express, statutory implied or by description in this publication or other documents which are referenced by or linked to this publication. In no event shall SONiX be liable for any special, incidental, indirect or consequential damages of any kind, or any damages whatsoever, including, without limitation, those resulting from loss of use, data or profits, whether or not advised of the possibility of damage, and on any theory of liability, arising out of or in connection with the use or performance of this publication or other documents which are referenced by or linked to this publication.

This publication was developed for products offered in Taiwan. SONiX may not offer the products discussed in this document in other countries. Information is subject to change without notice. Please contact SONiX or its local representative for information on offerings available. Integrated circuits sold by SONiX are covered by the warranty and patent indemnification provisions stipulated in the terms of sale only. The application circuits illustrated in this document are for reference purposes only. SONIX DISCLAIMS ALL WARRANTIES, INCLUDING THE WARRANTY OF MERCHANTABILITY OR FITNESS FOR ANY PURPOSE. SONIX reserves the right to halt production or alter the specifications and prices, and discontinue marketing the Products listed at any time without notice. Accordingly, the reader is cautioned to verify that the data sheets and other information in this publication are current before placing orders.

Products described herein are intended for use in normal commercial applications. Applications involving unusual environmental or reliability requirements, e.g. military equipment or medical life support equipment, are specifically not recommended without additional processing by SONIX for such application.