

CLOCKED BIDIRECTIONAL FIRST-IN, FIRST-OUT MEMORY

SCAS228D – JUNE 1992 – REVISED APRIL 1998

- Free-Running CLKA and CLKB Can Be Asynchronous or Coincident
- Two Independent 512 × 32 Clocked FIFOs Buffering Data in Opposite Directions
- Read Retransmit Capability From FIFO on Port B
- Mailbox-Bypass Register for Each FIFO
- Programmable Almost-Full and Almost-Empty Flags
- Microprocessor Interface Control Logic
- IRA, ORA,  $\overline{AEA}$ , and  $\overline{AFA}$  Flags Synchronized by CLKA
- IRB, ORB,  $\overline{AEB}$ , and  $\overline{AFB}$  Flags Synchronized by CLKB
- Low-Power 0.8- $\mu$ m Advanced CMOS Technology
- Supports Clock Frequencies up to 67 MHz
- Fast Access Times of 11 ns
- Package Options Include 120-Pin Thin Quad Flat (PCB) and 132-Pin Quad Flat (PQ) Packages

PCB PACKAGE  
(TOP VIEW)

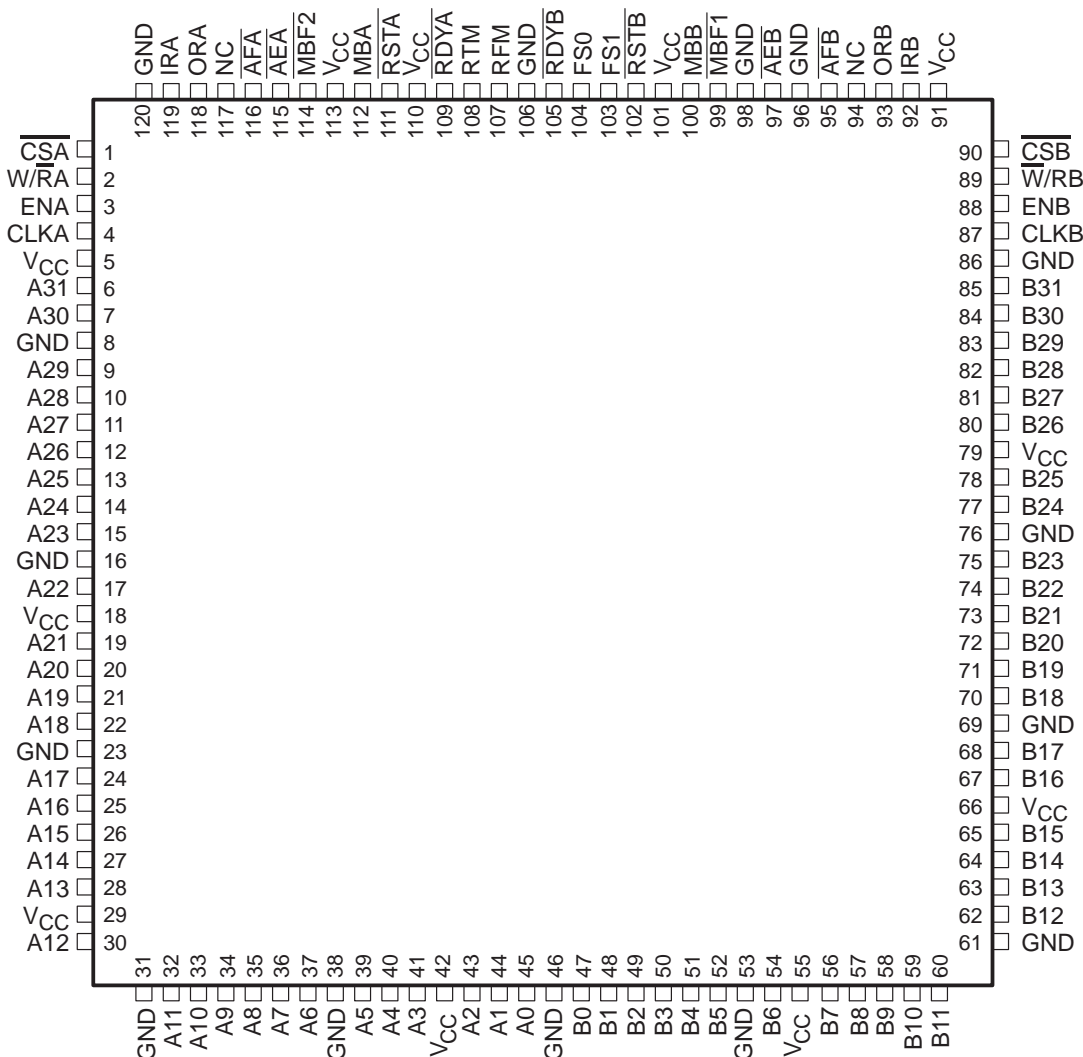

NC – No internal connection



Please be aware that an important notice concerning availability, standard warranty, and use in critical applications of Texas Instruments semiconductor products and disclaimers thereto appears at the end of this data sheet.

PRODUCTION DATA information is current as of publication date. Products conform to specifications per the terms of Texas Instruments standard warranty. Production processing does not necessarily include testing of all parameters.



POST OFFICE BOX 655303 • DALLAS, TEXAS 75265

Copyright © 1998, Texas Instruments Incorporated

**SN74ACT3638**

**512 × 32 × 2**

**CLOCKED BIDIRECTIONAL FIRST-IN, FIRST-OUT MEMORY**

SCAS228D – JUNE 1992 – REVISED APRIL 1998

**PQ PACKAGE†  
(TOP VIEW)**

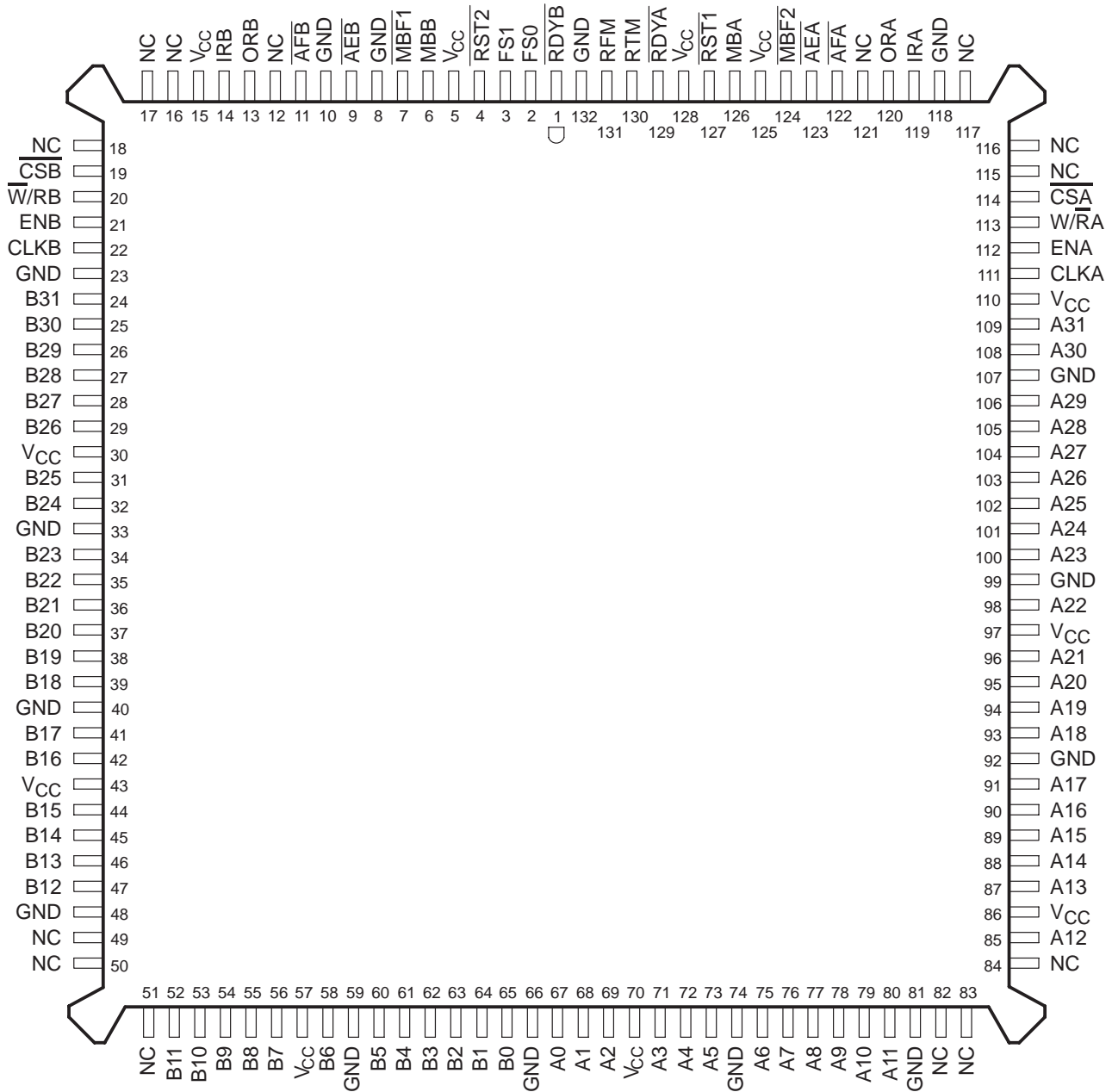

NC – No internal connection

† Uses Yamaichi socket IC51-1324-828



POST OFFICE BOX 655303 • DALLAS, TEXAS 75265

**description**

The SN74ACT3638 is a high-speed, low-power CMOS clocked bidirectional FIFO memory. It supports clock frequencies up to 67 MHz and has read access times as fast as 11 ns. Two independent 512 × 32 dual-port SRAM FIFOs on the chip buffer data in opposite directions. The FIFO memory buffering data from port A to port B has retransmit capability, which allows previously read data to be accessed again. Each FIFO has flags to indicate empty and full conditions and two programmable flags (almost full and almost empty) to indicate when a selected number of words is stored in memory. Communication between each port can bypass the FIFOs via two 32-bit mailbox registers. Each mailbox register has a flag to signal when new mail has been stored. Two or more devices can be used in parallel to create wider datapaths.

The SN74ACT3638 is a clocked FIFO, which means each port employs a synchronous interface. All data transfers through a port are gated to the low-to-high transition of a continuous (free-running) port clock by enable signals. The continuous clocks for each port are independent of one another and can be asynchronous or coincident. The enables for each port are arranged to provide a simple bidirectional interface between microprocessors and/or buses with synchronous control.

The input-ready (IRA, IRB) flags and almost-full ( $\overline{AFA}$ ,  $\overline{AFB}$ ) flags of the SN74ACT3638 are two-stage synchronized to the port clock that writes data to its array. The output-ready (ORA, ORB) flags and almost-empty ( $\overline{AEA}$ ,  $\overline{AEB}$ ) flags of the SN74ACT3638 are two-stage synchronized to the port clock that reads data from its array. Offsets for the almost-full and almost-empty flags of both FIFOs can be programmed from port A.

The SN74ACT3638 is characterized for operation from 0°C to 70°C.

For more information on this device family, see the application reports *FIFO Mailbox-Bypass Registers: Using Bypass Registers to Initialize DMA Control* (literature number SCAA007) and *Metastability Performance of Clocked FIFOs* (literature number SCZA004).

functional block diagram

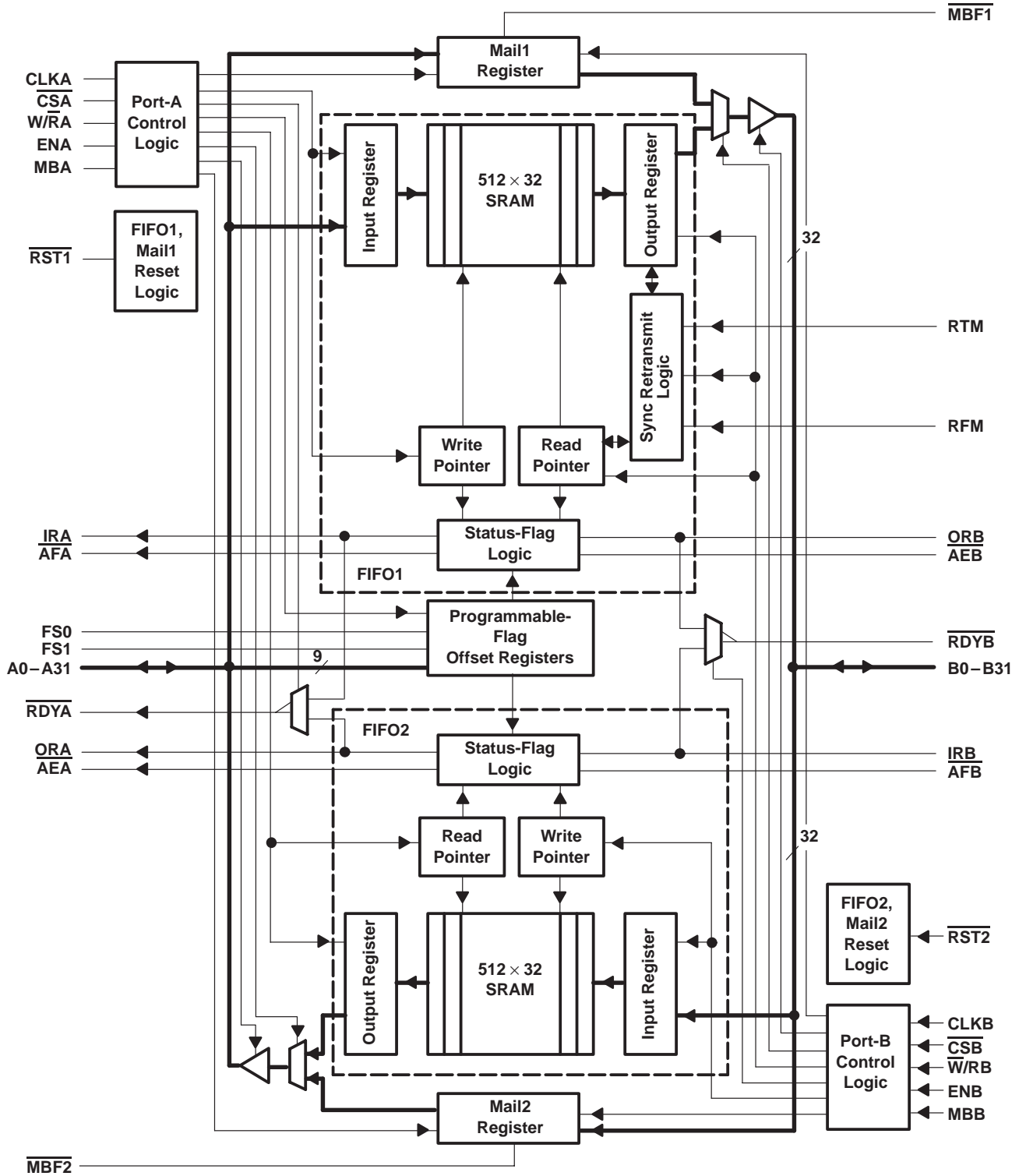

## CLOCKED BIDIRECTIONAL FIRST-IN, FIRST-OUT MEMORY

SCAS228D – JUNE 1992 – REVISED APRIL 1998

## Terminal Functions

TERMINAL NAME	I/O	DESCRIPTION
A0–A31	I/O	Port-A data. The 32-bit bidirectional data port for side A.
$\overline{AEA}$	O (port A)	Port-A almost-empty flag. Programmable flag synchronized to CLKA. $\overline{AEA}$ is low when the number of words in FIFO2 is less than or equal to the value in the almost-empty A offset register, X2.
$\overline{AEB}$	O (port B)	Port-B almost-empty flag. Programmable flag synchronized to CLKB. $\overline{AEB}$ is low when the number of words in FIFO1 is less than or equal to the value in the almost-empty B offset register, X1.
$\overline{AFA}$	O (port A)	Port-A almost-full flag. Programmable flag synchronized to CLKA. $\overline{AFA}$ is low when the number of empty locations in FIFO1 is less than or equal to the value in the almost-full A offset register, Y1.
$\overline{AFB}$	O (port B)	Port-B almost-full flag. Programmable flag synchronized to CLKB. $\overline{AFB}$ is low when the number of empty locations in FIFO2 is less than or equal to the value in the almost full B offset register, Y2.
B0–B31	I/O	Port-B data. The 32-bit bidirectional data port for side B.
CLKA	I	Port-A clock. CLKA is a continuous clock that synchronizes all data transfers through port A and can be asynchronous or coincident to CLKB. IRA, ORA, $\overline{AFA}$ , and $\overline{AEA}$ are synchronous to the low-to-high transition of CLKA.
CLKB	I	Port-B clock. CLKB is a continuous clock that synchronizes all data transfers through port B and can be asynchronous or coincident to CLKA. IRB, ORB, $\overline{AFB}$ , and $\overline{AEB}$ are synchronous to the low-to-high transition of CLKB.
$\overline{CSA}$	I	Port-A chip select. $\overline{CSA}$ must be low to enable a low-to-high transition of CLKA to read or write data on port A. The A0–A31 outputs are in the high-impedance state when $\overline{CSA}$ is high.
$\overline{CSB}$	I	Port-B chip select. $\overline{CSB}$ must be low to enable a low-to-high transition of CLKB to read or write data on port B. The B0–B31 outputs are in the high-impedance state when $\overline{CSB}$ is high.
ENA	I	Port-A enable. ENA must be high to enable a low-to-high transition of CLKA to read or write data on port A.
ENB	I	Port-B enable. ENB must be high to enable a low-to-high transition of CLKB to read or write data on port B.
FS1, FS0	I	Flag-offset selects. The low-to-high transition of a FIFO reset input latches the values of FS0 and FS1. If either FS0 or FS1 is high when a reset input goes high, one of three preset values is selected as the offset for the FIFO almost-full and almost-empty flags. If both FIFOs are reset simultaneously and both FS0 and FS1 are low when RST1 and RST2 go high, the first four writes to FIFO1 program the almost-full and almost-empty offsets for both FIFOs.
IRA	O (port A)	Port-A input-ready flag. IRA is synchronized to the low-to-high transition of CLKA. When IRA is low, FIFO1 is full and writes to its array are disabled. When FIFO1 is in retransmit mode, IRA indicates when the memory has been filled to the point of the retransmit data and prevents further writes. IRA is set low when FIFO1 is reset and is set high on the second low-to-high transition of CLKA after reset.
IRB	O (port B)	Port-B input-ready flag. IRB is synchronized to the low-to-high transition of CLKB. When IRB is low, FIFO2 is full and writes to its array are disabled. IRB is set low when FIFO2 is reset and is set high on the second low-to-high transition of CLKB after reset.
MBA	I	Port-A mailbox select. A high level on MBA chooses a mailbox register for a port-A read or write operation. When the A0–A31 outputs are active, a high level on MBA selects data from the mail2 register for output and a low level selects FIFO2 output-register data for output.
MBB	I	Port-B mailbox select. A high level on MBB chooses a mailbox register for a port-B read or write operation. When the B0–B31 outputs are active, a high level on MBB selects data from the mail1 register for output and a low level selects FIFO1 output-register data for output.
$\overline{MBF1}$	O	Mail1 register flag. $\overline{MBF1}$ is set low by the low-to-high transition of CLKA that writes data to the mail1 register. Writes to the mail1 register are inhibited while $\overline{MBF1}$ is low. $\overline{MBF1}$ is set high by a low-to-high transition of CLKB when a port-B read is selected and MBB is high. $\overline{MBF1}$ is set high when FIFO1 is reset.
$\overline{MBF2}$	O	Mail2 register flag. $\overline{MBF2}$ is set low by the low-to-high transition of CLKB that writes data to the mail2 register. Writes to the mail2 register are inhibited while $\overline{MBF2}$ is low. $\overline{MBF2}$ is set high by a low-to-high transition of CLKA when a port-A read is selected and MBA is high. $\overline{MBF2}$ is set high when FIFO2 is reset.
ORA	O (port A)	Port-A output-ready flag. ORA is synchronized to the low-to-high transition of CLKA. When ORA is low, FIFO2 is empty and reads from its memory are disabled. Ready data is present on the output register of FIFO2 when ORA is high. ORA is forced low when FIFO2 is reset and goes high on the third low-to-high transition of CLKA after a word is loaded to empty memory.

## Terminal Functions (Continued)

TERMINAL NAME	I/O	DESCRIPTION
ORB	O (port B)	Port-B output-ready flag. ORB is synchronized to the low-to-high transition of CLKB. When ORB is low, FIFO1 is empty and reads from its memory are disabled. Ready data is present on the output register of FIFO1 when ORB is high. ORB is forced low when FIFO1 is reset and goes high on the third low-to-high transition of CLKB after a word is loaded to empty memory.
$\overline{\text{RDYA}}$	O (port A)	Port-A ready. A high on $\overline{\text{W/RA}}$ selects the inverted state of IRA for output on $\overline{\text{RDYA}}$ , and a low on $\overline{\text{W/RA}}$ selects the inverted state of ORA for output on $\overline{\text{RDYA}}$ .
$\overline{\text{RDYB}}$	O (port B)	Port-B ready. A low on $\overline{\text{W/RB}}$ selects the inverted state of IRB for output on $\overline{\text{RDYB}}$ , and a high on $\overline{\text{W/RB}}$ selects the inverted state of ORB for output on $\overline{\text{RDYB}}$ .
RFM	I	FIFO1 read from mark. When FIFO1 is in retransmit mode, a high on RFM enables a low-to-high transition of CLKB to reset the FIFO1 read pointer to the retransmit location and output the first retransmit data.
$\overline{\text{RST1}}$	I	FIFO1 reset. To reset FIFO1, four low-to-high transitions of CLKA and four low-to-high transitions of CLKB must occur while $\overline{\text{RST1}}$ is low. The low-to-high transition of $\overline{\text{RST1}}$ latches the status of FS0 and FS1 for $\overline{\text{AFA}}$ and $\overline{\text{AEB}}$ offset selection. FIFO1 must be reset upon power up before data is written to its RAM.
$\overline{\text{RST2}}$	I	FIFO2 reset. To reset FIFO2, four low-to-high transitions of CLKA and four low-to-high transitions of CLKB must occur while $\overline{\text{RST2}}$ is low. The low-to-high transition of $\overline{\text{RST2}}$ latches the status of FS0 and FS1 for $\overline{\text{AFB}}$ and $\overline{\text{AEA}}$ offset selection. FIFO2 must be reset upon power up before data is written to its RAM.
RTM	I	FIFO1 retransmit mode. When RTM is high and valid data is present on the output of FIFO1, a low-to-high transition of CLKB selects the data for the beginning of a FIFO1 retransmit. The selected position remains the initial retransmit point until a low-to-high transition of CLKB occurs while RTM is low, which takes FIFO out of retransmit mode.
$\overline{\text{W/RA}}$	I	Port-A write/read select. A high on $\overline{\text{W/RA}}$ selects a write operation and a low selects a read operation on port A for a low-to-high transition of CLKA. The A0–A31 outputs are in the high-impedance state when $\overline{\text{W/RA}}$ is high.
$\overline{\text{W/RB}}$	I	Port-B write/read select. A low on $\overline{\text{W/RB}}$ selects a write operation and a high selects a read operation on port B for a low-to-high transition of CLKB. The B0–B31 outputs are in the high-impedance state when $\overline{\text{W/RB}}$ is low.

## detailed description

## reset

The FIFO memories of the SN74ACT3638 are reset separately by taking their reset ( $\overline{\text{RST1}}$ ,  $\overline{\text{RST2}}$ ) inputs low for at least four port-A clock (CLKA) and four port-B clock (CLKB) low-to-high transitions. The reset inputs can switch asynchronously to the clocks. A FIFO reset initializes the internal read and write pointers and forces the input-ready flag (IRA, IRB) low, the output-ready flag (ORA, ORB) low, the almost-empty flag ( $\overline{\text{AEA}}$ ,  $\overline{\text{AEB}}$ ) low, and the almost-full flag ( $\overline{\text{AFA}}$ ,  $\overline{\text{AFB}}$ ) high. Resetting a FIFO also forces the mailbox flag ( $\overline{\text{MBF1}}$ ,  $\overline{\text{MBF2}}$ ) of the parallel mailbox register high. After a FIFO is reset, its input-ready flag is set high after two clock cycles to begin normal operation. A FIFO must be reset after power up before data is written to its memory.

A low-to-high transition on a FIFO reset ( $\overline{\text{RST1}}$ ,  $\overline{\text{RST2}}$ ) input latches the value of the flag-select (FS0, FS1) inputs for choosing the almost-full and almost-empty offset programming method (see *almost-empty and almost-full flag offset programming*).

## almost-empty flag and almost-full flag offset programming

Four registers in the SN74ACT3638 are used to hold the offset values for the almost-empty and almost-full flags. The port-B almost-empty flag ( $\overline{\text{AEB}}$ ) offset register is labeled X1, and the port-A almost-empty flag ( $\overline{\text{AEA}}$ ) offset register is labeled X2. The port-A almost-full flag ( $\overline{\text{AFA}}$ ) offset register is labeled Y1, and the port-B almost-full flag ( $\overline{\text{AFB}}$ ) offset register is labeled Y2. The index of each register name corresponds to its FIFO number. The offset registers can be loaded with preset values during the reset of a FIFO or they can be programmed from port A (see Table 1).

## almost-empty flag and almost-full flag offset programming (continued)

Table 1. Flag Programming

FS1	FS0	RST1	RST2	X1 AND Y1 REGISTERS†	X2 AND Y2 REGISTERS‡
H	H	↑	X	64	X
H	H	X	↑	X	64
H	L	↑	X	16	X
H	L	X	↑	X	16
L	H	↑	X	8	X
L	H	X	↑	X	8
L	L	↑	↑	Programmed from port A	Programmed from port A

† X1 register holds the offset for  $\overline{AEB}$ ; Y1 register holds the offset for  $\overline{AFA}$ .

‡ X2 register holds the offset for  $\overline{AEA}$ ; Y2 register holds the offset for  $\overline{AFB}$ .

To load the almost-empty flag and almost-full flag offset registers of a FIFO with one of the three preset values listed in Table 1, at least one of the flag-select inputs must be high during the low-to-high transition of its reset input. For example, to load the preset value of 64 into X1 and Y1, FS0 and FS1 must be high when FIFO1 reset ( $\overline{RST1}$ ) returns high. Flag-offset registers associated with FIFO2 are loaded with one of the preset values in the same way with FIFO2 reset ( $\overline{RST2}$ ). When using one of the preset values for the flag offsets, the FIFOs can be reset simultaneously or at different times.

To program the X1, X2, Y1, and Y2 registers from port A, both FIFOs should be reset simultaneously with FS0 and FS1 low during the low-to-high transition of the reset inputs. After this reset is complete, the first four writes to FIFO1 do not store data in RAM but load the offset registers in the order Y1, X1, Y2, X2. Each offset register uses port-A (A8–A0) inputs, with A8 as the most-significant bit. Each register value can be programmed from 1 to 508. After all the offset registers are programmed from port A, the port-B input-ready flag (IRB) is set high, and both FIFOs begin normal operation.

## FIFO write/read operation

The state of the port-A data (A0–A31) outputs is controlled by the port-A chip select ( $\overline{CSA}$ ) and the port-A write/read select ( $W/\overline{RA}$ ). The A0–A31 outputs are in the high-impedance state when either  $\overline{CSA}$  or  $W/\overline{RA}$  is high. The A0–A31 outputs are active when both  $\overline{CSA}$  and  $W/\overline{RA}$  are low.

Data is loaded into FIFO1 from the A0–A31 inputs on a low-to-high transition of CLKA when  $\overline{CSA}$  is low,  $W/\overline{RA}$  is high, ENA is high, MBA is low, and IRA is high. Data is read from FIFO2 to the A0–A31 outputs by a low-to-high transition of CLKA when  $\overline{CSA}$  is low,  $W/\overline{RA}$  is low, ENA is high, MBA is low, and ORA is high (see Table 2). FIFO reads and writes on port A are independent of any concurrent port-B operation.

Table 2. Port-A Enable Function Table

$\overline{CSA}$	$W/\overline{RA}$	ENA	MBA	CLKA	A0–A31 OUTPUTS	PORT FUNCTION
H	X	X	X	X	In high-impedance state	None
L	H	L	X	X	In high-impedance state	None
L	H	H	L	↑	In high-impedance state	FIFO1 write
L	H	H	H	↑	In high-impedance state	Mail1 write
L	L	L	L	X	Active, FIFO2 output register	None
L	L	H	L	↑	Active, FIFO2 output register	FIFO2 read
L	L	L	H	X	Active, mail2 register	None
L	L	H	H	↑	Active, mail2 register	Mail2 read (set $\overline{MBF2}$ high)



**FIFO write/read operation (continued)**

The port-B control signals are identical to those of port A with the exception that the port-B write/read select ( $\overline{W/RB}$ ) is the inverse of the port-A write/read select ( $W/RA$ ). The state of the port-B data (B0–B31) outputs is controlled by the port-B chip select ( $\overline{CSB}$ ) and the port-B write/read select ( $\overline{W/RB}$ ). The B0–B31 outputs are in the high-impedance state when either  $\overline{CSB}$  is high or  $\overline{W/RB}$  is low. The B0–B31 outputs are active when  $\overline{CSB}$  is low and  $\overline{W/RB}$  is high.

Data is loaded into FIFO2 from the B0–B31 inputs on a low-to-high transition of CLKB when  $\overline{CSB}$  is low,  $\overline{W/RB}$  is low, ENB is high, MBB is low, and IRB is high. Data is read from FIFO1 to the B0–B31 outputs by a low-to-high transition of CLKB when  $\overline{CSB}$  is low,  $\overline{W/RB}$  is high, ENB is high, MBB is low, and ORB is high (see Table 3). FIFO reads and writes on port B are independent of any concurrent port-A operation.

**Table 3. Port-B Enable Function Table**

$\overline{CSB}$	$\overline{W/RB}$	ENB	MBB	CLKB	B0–B31 OUTPUTS	PORT FUNCTION
H	X	X	X	X	In high-impedance state	None
L	L	L	X	X	In high-impedance state	None
L	L	H	L	↑	In high-impedance state	FIFO2 write
L	L	H	H	↑	In high-impedance state	Mail2 write
L	H	L	L	X	Active, FIFO1 output register	None
L	H	H	L	↑	Active, FIFO1 output register	FIFO1 read
L	H	L	H	X	Active, mail1 register	None
L	H	H	H	↑	Active, mail1 register	Mail1 read (set $\overline{MBF1}$ high)

The setup- and hold-time constraints to the port clocks for the port-chip selects and write/read selects are only for enabling write and read operations and are not related to high-impedance control of the data outputs. If a port enable is low during a clock cycle, the port-chip select and write/read select can change states during the setup- and hold-time window of the cycle.

When a FIFO output-ready flag is low, the next data word is sent to the FIFO output register automatically by the low-to-high transition of the port clock that sets the output-ready flag high. When the output-ready flag is high, an available data word is clocked to the FIFO output register only when a FIFO read is selected by the port-chip select, write/read select, enable, and mailbox select.

**synchronized FIFO flags**

Each FIFO is synchronized to its port clock through at least two flip-flop stages. This is done to improve flag-signal reliability by reducing the probability of metastable events when CLKA and CLKB operate asynchronously to one another. ORA,  $\overline{AEA}$ , IRA, and  $\overline{AFA}$  are synchronized to CLKA. ORB,  $\overline{AEB}$ , IRB, and  $\overline{AFB}$  are synchronized to CLKB. Tables 4 and 5 show the relationship of each port flag to FIFO1 and FIFO2.



## synchronized FIFO flags (continued)

Table 4. FIFO1 Flag Operation

NUMBER OF WORDS IN FIFO1†‡	SYNCHRONIZED TO CLKB		SYNCHRONIZED TO CLKA	
	ORB	$\overline{\text{AEB}}$	$\overline{\text{AFA}}$	IRA
0	L	L	H	H
1 to X1	H	L	H	H
(X1 + 1) to [512 – (Y1 + 1)]	H	H	H	H
(512 – Y1) to 511	H	H	L	H
512	H	H	L	L

† X1 is the almost-empty offset for FIFO1 used by AEB. Y1 is the almost-full offset for FIFO1 used by AFA. Both X1 and Y1 are selected during a reset of FIFO1 or programmed from port A.

‡ When a word loaded to an empty FIFO is shifted to the output register, its previous FIFO memory location is free.

Table 5. FIFO2 Flag Operation

NUMBER OF WORDS IN FIFO2‡§	SYNCHRONIZED TO CLKA		SYNCHRONIZED TO CLKB	
	ORA	$\overline{\text{AEA}}$	$\overline{\text{AFB}}$	IRB
0	L	L	H	H
1 to X2	H	L	H	H
(X2 + 1) to [512 – (Y2 + 1)]	H	H	H	H
(512 – Y2) to 511	H	H	L	H
512	H	H	L	L

‡ When a word loaded to an empty FIFO is shifted to the output register, its previous FIFO memory location is free.

§ X2 is the almost-empty offset for FIFO2 used by AEA. Y2 is the almost-full offset for FIFO2 used by AFB. Both X2 and Y2 are selected during a reset of FIFO2 or programmed from port A.

**output-ready flags (ORA, ORB)**

The output-ready flag of a FIFO is synchronized to the port clock that reads data from its array. When the output-ready flag is high, new data is present in the FIFO output register. When the output-ready flag is low, the previous data word is present in the FIFO output register and attempted FIFO reads are ignored.

A FIFO read pointer is incremented each time a new word is clocked to its output register. From the time a word is written to a FIFO, it can be shifted to the FIFO output register in a minimum of three cycles of the output-ready flag synchronizing clock; therefore, an output-ready flag is low if a word in memory is the next data to be sent to the FIFO output register and three cycles of the port clock that reads data from the FIFO have not elapsed since the time the word was written. The output-ready flag of the FIFO remains low until the third low-to-high transition of the synchronizing clock occurs, simultaneously forcing the output-ready flag high and shifting the word to the FIFO output register.

A low-to-high transition on an output-ready flag synchronizing clock begins the first synchronization cycle of a write if the clock transition occurs at time  $t_{sk1}$ , or greater, after the write. Otherwise, the subsequent clock cycle can be the first synchronization cycle (see Figures 7 and 8).

**input-ready flags (IRA, IRB)**

The input-ready flag of a FIFO is synchronized to the port clock that writes data to its array. When the input-ready flag is high, a memory location is free in the SRAM to receive new data. No memory locations are free when the input-ready flag is low and attempted writes to the FIFO are ignored.

Each time a word is written to a FIFO, its write pointer is incremented. From the time a word is read from a FIFO, its previous memory location is ready to be written in a minimum of two cycles of the input-ready flag synchronizing clock; therefore, an input-ready flag is low if less than two cycles of the input-ready flag synchronizing clock have elapsed since the next memory write location has been read. The second low-to-high transition on the input-ready flag synchronizing clock after the read sets the input-ready flag high.

A low-to-high transition on an input-ready flag synchronizing clock begins the first synchronization cycle of a read if the clock transition occurs at time  $t_{sk1}$ , or greater, after the read. Otherwise, the subsequent clock cycle can be the first synchronization cycle (see Figures 9 and 10).

**ready flags ( $\overline{RDYA}$ ,  $\overline{RDYB}$ )**

A ready flag is provided on each port to show if the transmitting or receiving FIFO chosen by the port write/read select is available for data transfer. The port-A ready flag ( $\overline{RDYA}$ ) outputs the complement of the IRA flag when  $\overline{W/RA}$  is high and the complement of the ORA flag when  $\overline{W/RA}$  is low. The port-B ready flag ( $\overline{RDYB}$ ) outputs the complement of the IRB flag when  $\overline{W/RB}$  is low and the complement of the ORB flag when  $\overline{W/RB}$  is high (see Figures 11 and 12).

**almost-empty flags ( $\overline{AEA}$ ,  $\overline{AEB}$ )**

The almost-empty flag of a FIFO is synchronized to the port clock that reads data from its array. The almost-empty state is defined by the contents of register X1 for  $\overline{AEB}$  and register X2 for  $\overline{AEA}$ . These registers are loaded with preset values during a FIFO reset or programmed from port A (see *almost-empty flag and almost-full flag offset programming*). A FIFO is almost empty when it contains X or fewer words in memory and is no longer almost empty when it contains (X + 1) or more words. Note that a data word present in the FIFO output register has been read from memory.

Two low-to-high transitions of the almost-empty flag synchronizing clock are required after a FIFO write for its almost-empty flag to reflect the new level of fill; therefore, the almost-empty flag of a FIFO containing (X + 1) or more words remains low if two cycles of its synchronizing clock have not elapsed since the write that filled the memory to the (X + 1) level. An almost-empty flag is set high by the second low-to-high transition of its synchronizing clock after the FIFO write that fills memory to the (X + 1) level. A low-to-high transition of an almost-empty flag synchronizing clock begins the first synchronization cycle if it occurs at time  $t_{sk2}$ , or greater, after the write that fills the FIFO to (X + 1) words. Otherwise, the subsequent synchronizing clock cycle can be the first synchronization cycle (see Figures 13 and 14).

**almost-full flags ( $\overline{AFA}$ ,  $\overline{AFB}$ )**

The almost-full flag of a FIFO is synchronized to the port clock that writes data to its array. The almost-full state is defined by the contents of register Y1 for  $\overline{AFA}$  and register Y2 for  $\overline{AFB}$ . These registers are loaded with preset values during a FIFO reset or programmed from port A (see *almost-empty flag and almost-full flag offset programming*). A FIFO is almost full when it contains (512 – Y) or more words in memory and is not almost full when it contains [512 – (Y + 1)] or fewer words. A data word present in the FIFO output register has been read from memory.

**almost-full flags ( $\overline{AFA}$ ,  $\overline{AFB}$ ) (continued)**

Two low-to-high transitions of the almost-full flag synchronizing clock are required after a FIFO read for its almost-full flag to reflect the new level of fill; therefore, the almost-full flag of a FIFO containing [512 – (Y + 1)] or fewer words remains low if two cycles of its synchronizing clock have not elapsed since the read that reduced the number of words in memory to [512 – (Y + 1)]. An almost-full flag is set high by the second low-to-high transition of its synchronizing clock after the FIFO read that reduces the number of words in memory to [512 – (Y + 1)]. A low-to-high transition of an almost-full flag synchronizing clock begins the first synchronization

cycle if it occurs at time  $t_{sk2}$ , or greater, after the read that reduces the number of words in memory to  $[512 - (Y + 1)]$ . Otherwise, the subsequent synchronizing clock cycle may be the first synchronization cycle (see Figures 15 and 16).

### synchronous retransmit

The synchronous retransmit feature of the SN74ACT3638 allows FIFO1 data to be read repeatedly, starting at a user-selected position. FIFO1 is first put into retransmit mode to select a beginning word and prevent ongoing FIFO write operations from destroying retransmit data. Data vectors with a minimum length of three words can retransmit repeatedly, starting at the selected word. FIFO1 can be taken out of retransmit mode at any time and allow normal operation.

FIFO1 is put in retransmit mode by a low-to-high transition on CLKB when the retransmit-mode (RTM) input is high and ORB is high. This rising CLKB edge marks the data present in the FIFO1 output register as the first retransmit data. FIFO1 remains in retransmit mode until a low-to-high transition on CLKB occurs while RTM is low.

When two or more reads have been completed past the initial retransmit word, a retransmit is initiated by a low-to-high transition on CLKB when the read-from-mark (RFM) input is high. This rising CLKB edge shifts the first retransmit word to the FIFO1 output register and subsequent reads can begin immediately. Retransmit loops can be done endlessly while FIFO1 is in retransmit mode. RFM should not be high during the CLKB rising edge that takes the FIFO1 out of retransmit mode.

When FIFO1 is put into retransmit mode, it operates with two read pointers. The current read pointer operates normally, incrementing each time a new word is shifted to the FIFO1 output register and used by the ORB and  $\overline{AEB}$  flags. The shadow read pointer stores the SRAM location at the time FIFO1 is put into retransmit mode and does not change until FIFO1 is taken out of retransmit mode. The shadow read pointer is used by the IRA and  $\overline{AFA}$  flags. Data writes can proceed while FIFO1 is in retransmit mode,  $\overline{AFA}$  is set low by the write that stores  $(512 - Y1)$  words after the first retransmit word, and IR is set low by the 512th write after the first retransmit word.

When FIFO1 is in retransmit mode and RFM is high, a rising CLKB edge loads the current read pointer with the shadow read-pointer value and the ORB flag reflects the new level of fill immediately. If the retransmit changes the FIFO1 status out of the almost-empty range, up to two CLKB rising edges after the retransmit cycle are needed to switch  $\overline{AEB}$  high (see Figure 18). The rising CLKB edge that takes FIFO1 out of retransmit mode shifts the read pointer used by the IRA and  $\overline{AFA}$  flags from the shadow to the current read pointer. If the change of read pointer used by IRA and  $\overline{AFA}$  should cause one or both flags to transition high, at least two CLKA synchronizing cycles are needed before the flags reflect the change. A rising CLKA edge after FIFO1 is taken out of retransmit mode is the first synchronizing cycle of IRA if it occurs at time  $t_{sk1}$  or greater after the rising CLKB edge (see Figure 19). A rising CLKA edge after FIFO1 is taken out of retransmit mode is the first synchronizing cycle of  $\overline{AFA}$  if it occurs at time  $t_{sk2}$ , or greater, after the rising CLKB edge (see Figure 20).

### mailbox registers

Each FIFO has a 32-bit bypass register to pass command and control information between port A and port B without putting it in queue. The mailbox-select (MBA, MBB) inputs choose between a mail register and a FIFO for a port data-transfer operation. A low-to-high transition on CLKA writes A0–A31 data to the mail1 register when a port-A write is selected by  $\overline{CSA}$ ,  $\overline{W/RA}$ , and ENA and with MBA high. A low-to-high transition on CLKB writes B0–B31 data to the mail2 register when a port-B write is selected by  $\overline{CSB}$ ,  $\overline{W/RB}$ , and ENB and with MBB high. Writing data to a mail register sets its corresponding flag ( $\overline{MBF1}$  or  $\overline{MBF2}$ ) low. Attempted writes to a mail register are ignored while the mail flag is low.

### mailbox registers (continued)

When data outputs of a port are active, the data on the bus comes from the FIFO output register when the port mailbox-select input is low and from the mail register when the port mailbox-select input is high. The mail1 register flag ( $\overline{MBF1}$ ) is set high by a low-to-high transition on CLKB when a port-B read is selected by  $\overline{CSB}$ ,

$\overline{W}/\overline{R}B$ , and ENB and with MBB high. The mail2 register flag ( $\overline{MBF2}$ ) is set high by a low-to-high transition on CLKA when a port-A read is selected by  $\overline{CSA}$ ,  $\overline{W}/\overline{R}A$ , and ENA and with MBA high. The data in a mail register remains intact after it is read and changes only when new data is written to the register.

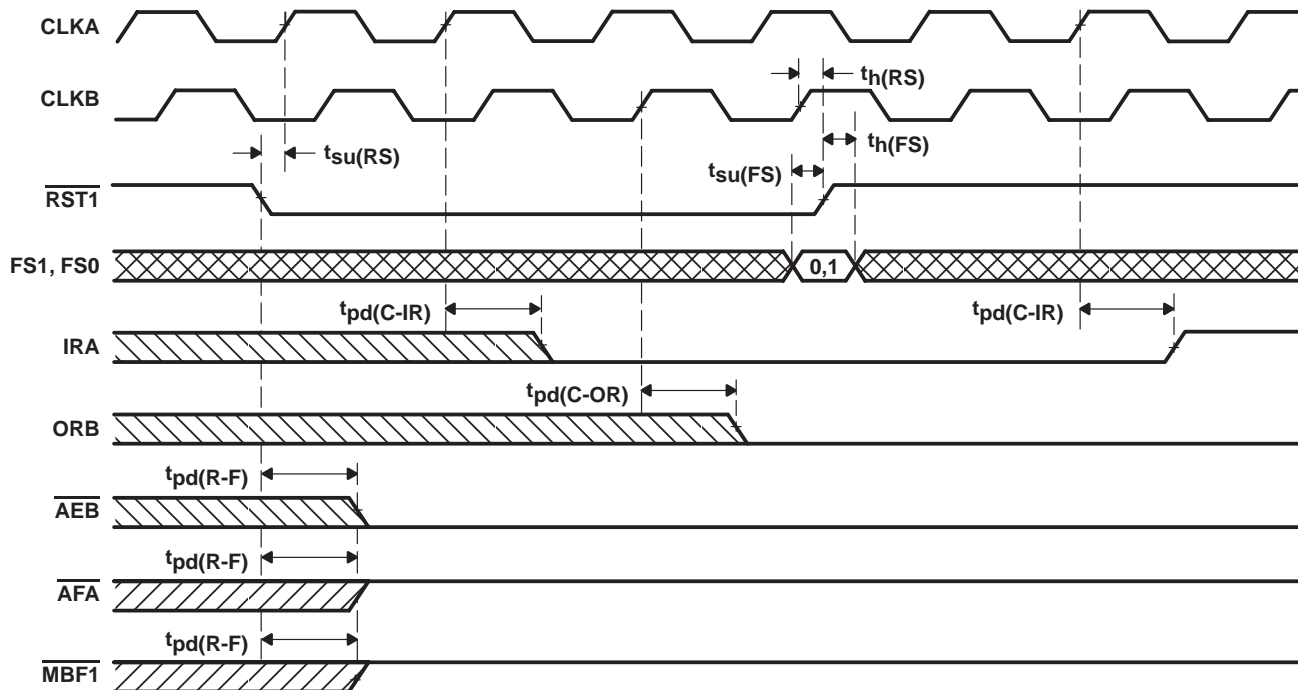
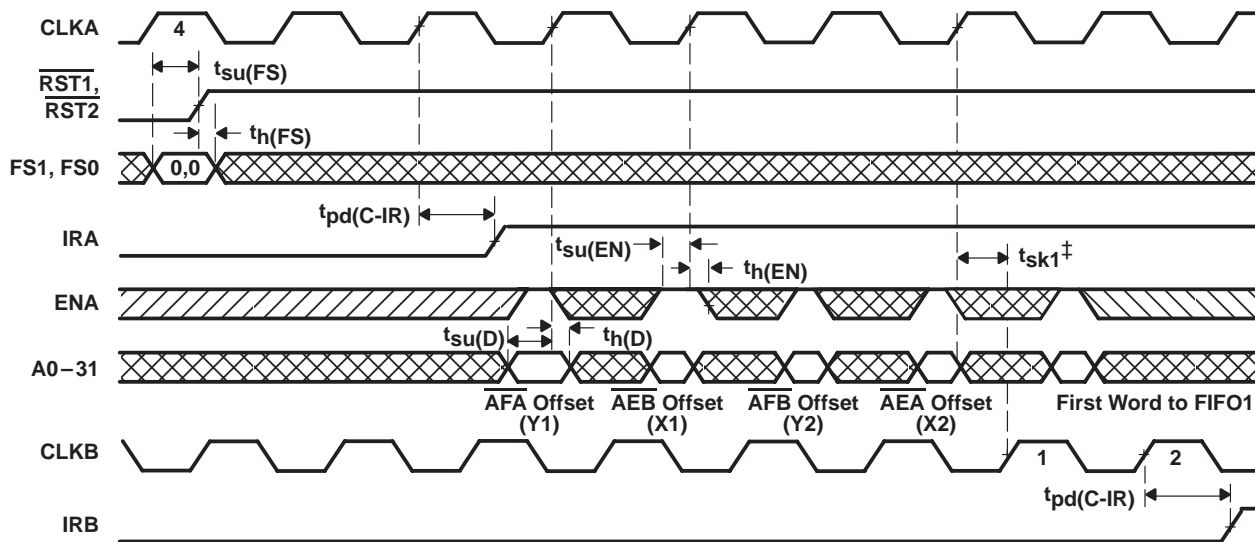

Figure 1. FIFO1 Reset Loading X1 and Y1 With a Preset Value of Eight†

† FIFO2 is reset in the same manner to load X2 and Y2 with a preset value.



†  $t_{sk1}$  is the minimum time between the rising CLKA edge and a rising CLKB edge for IRB to transition high in the next cycle. If the time between the rising edge of CLKA and rising edge of CLKB is less than  $t_{sk1}$ , then IRB may transition high one cycle later than shown.

NOTE A:  $\overline{CSA} = L$ ,  $\overline{W}/\overline{RA} = H$ ,  $MBA = L$ . It is not necessary to program offset register on consecutive clock cycles.

Figure 2. Programming the Almost-Full Flag and Almost-Empty Flag Offset Values After Reset



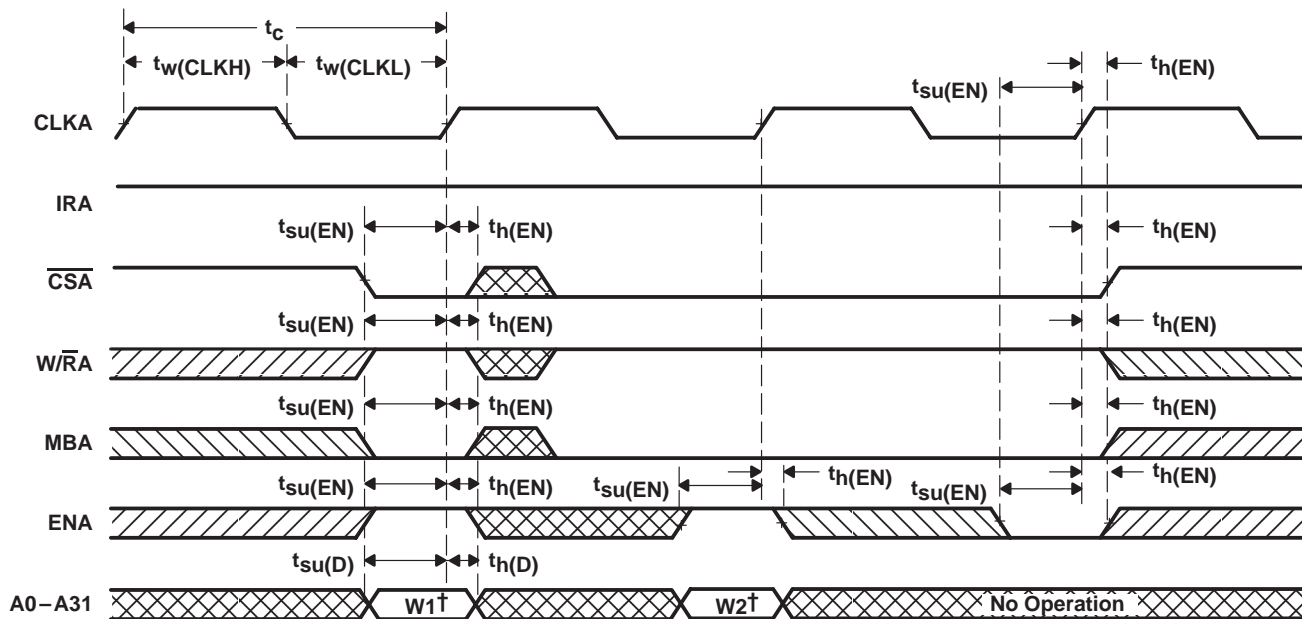

† Written to FIFO1

Figure 3. Port-A Write-Cycle Timing for FIFO1

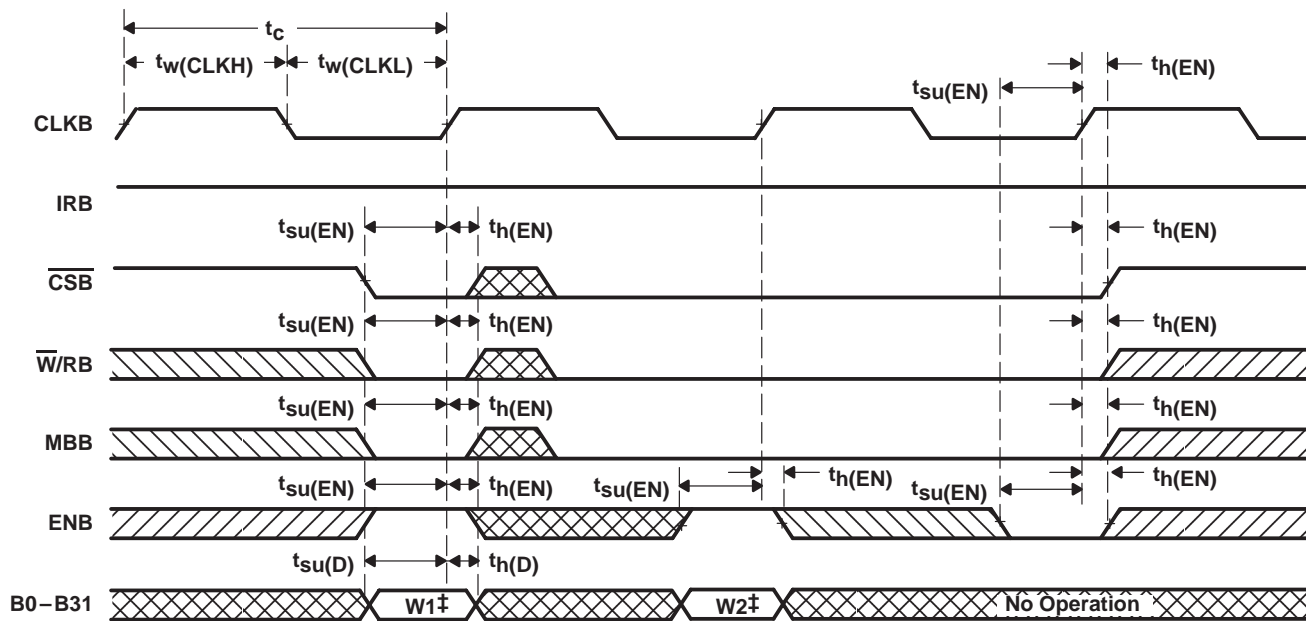

‡ Written to FIFO2

Figure 4. Port-B Write-Cycle Timing for FIFO2

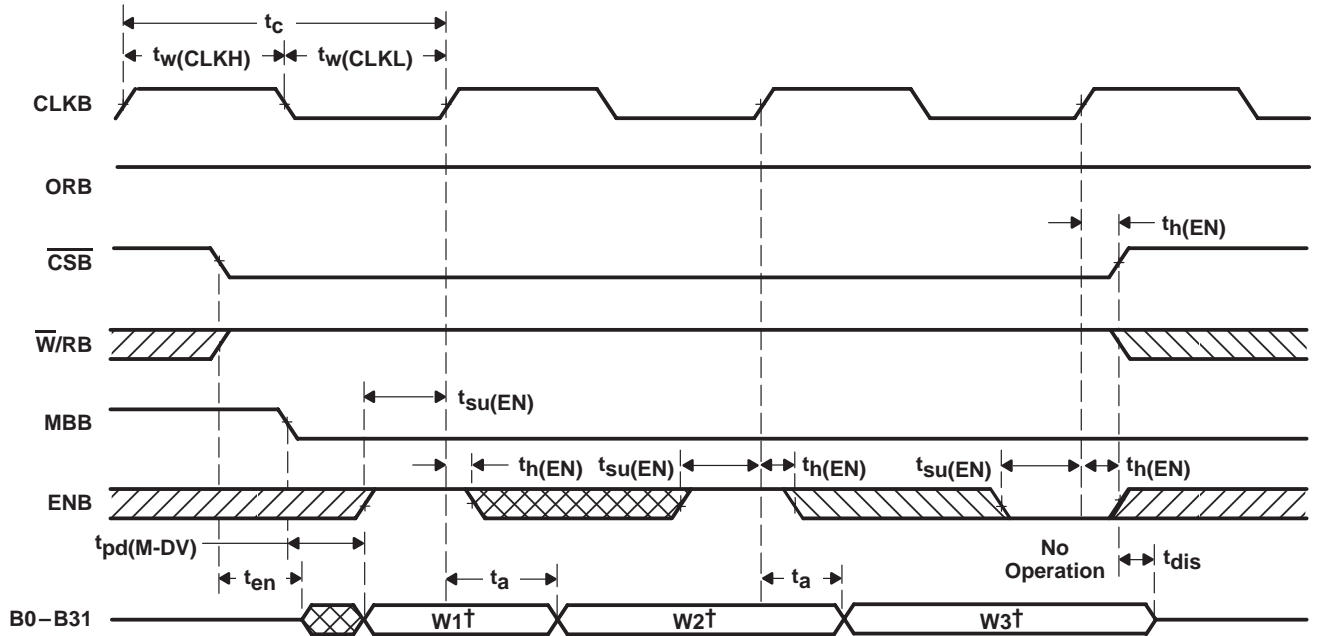

† Read from FIFO1

Figure 5. Port-B Read-Cycle Timing for FIFO1

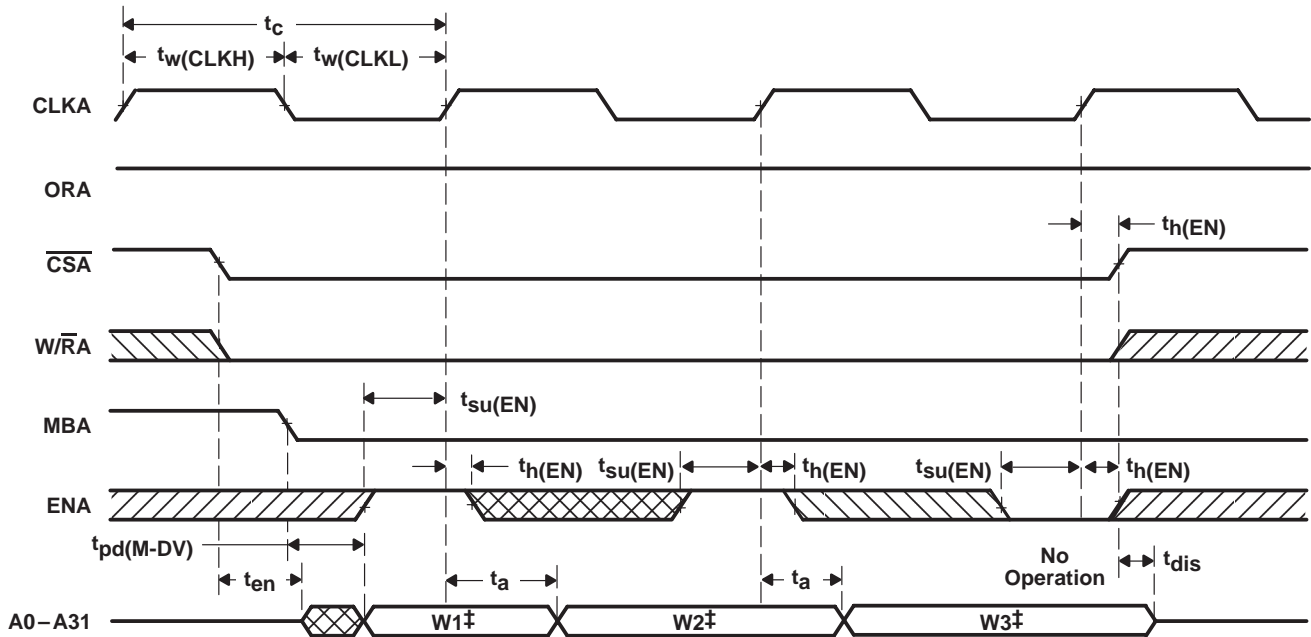

‡ Read from FIFO2

Figure 6. Port-A Read-Cycle Timing for FIFO2

CLOCKED BIDIRECTIONAL FIRST-IN, FIRST-OUT MEMORY

SCAS228D – JUNE 1992 – REVISED APRIL 1998

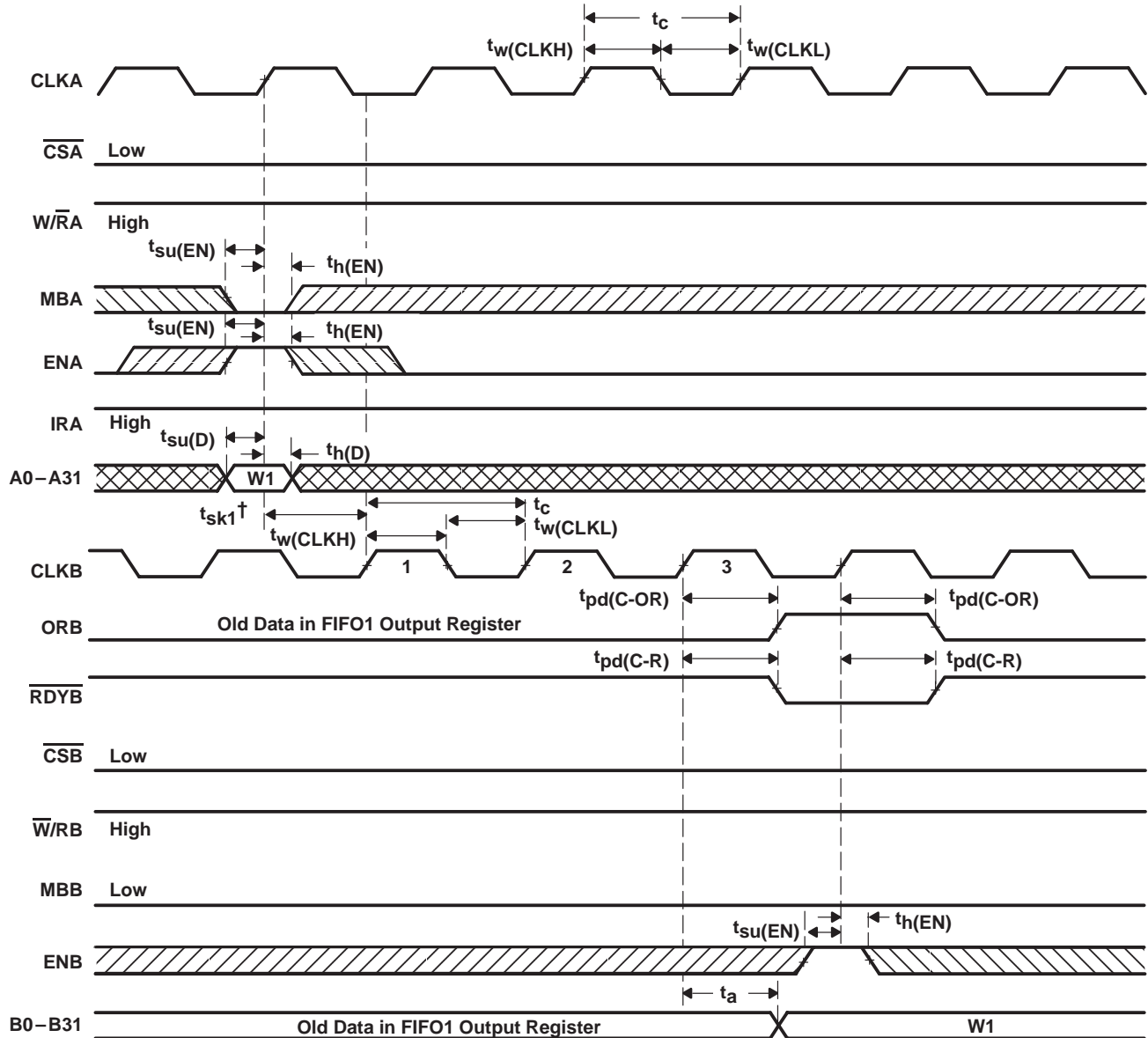

$t_{sk1}$  is the minimum time between a rising CLKA edge and a rising CLKB edge for ORB to transition high and to clock the next word to the FIFO1 output register in three CLKB cycles. If the time between the rising CLKA edge and rising CLKB edge is less than  $t_{sk1}$ , then the transition of ORB high and load of the first word to the output register may occur one CLKB cycle later than shown.

Figure 7. ORB-Flag Timing and First Data-Word Fall-Through When FIFO1 Is Empty



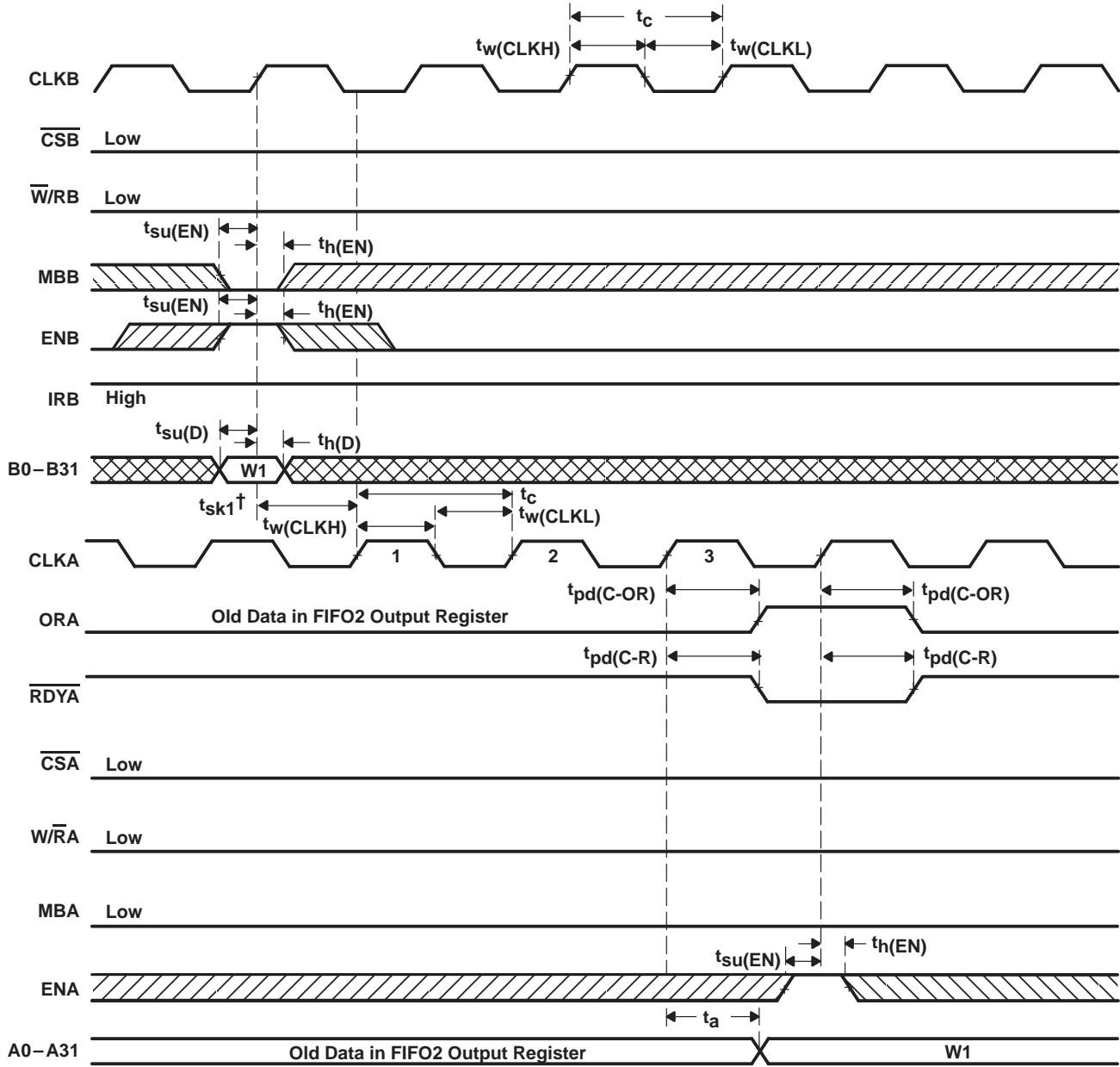

†  $t_{sk1}$  is the minimum time between a rising CLKB edge and a rising CLKA edge for ORA to transition high and to clock the next word to the FIFO2 output register in three CLKA cycles. If the time between the rising CLKB edge and rising CLKA edge is less than  $t_{sk1}$ , then the transition of ORA high and load of the first word to the output register may occur one CLKA cycle later than shown.

Figure 8. ORA-Flag Timing and First Data-Word Fall-Through When FIFO2 Is Empty

CLOCKED BIDIRECTIONAL FIRST-IN, FIRST-OUT MEMORY

SCAS228D – JUNE 1992 – REVISED APRIL 1998

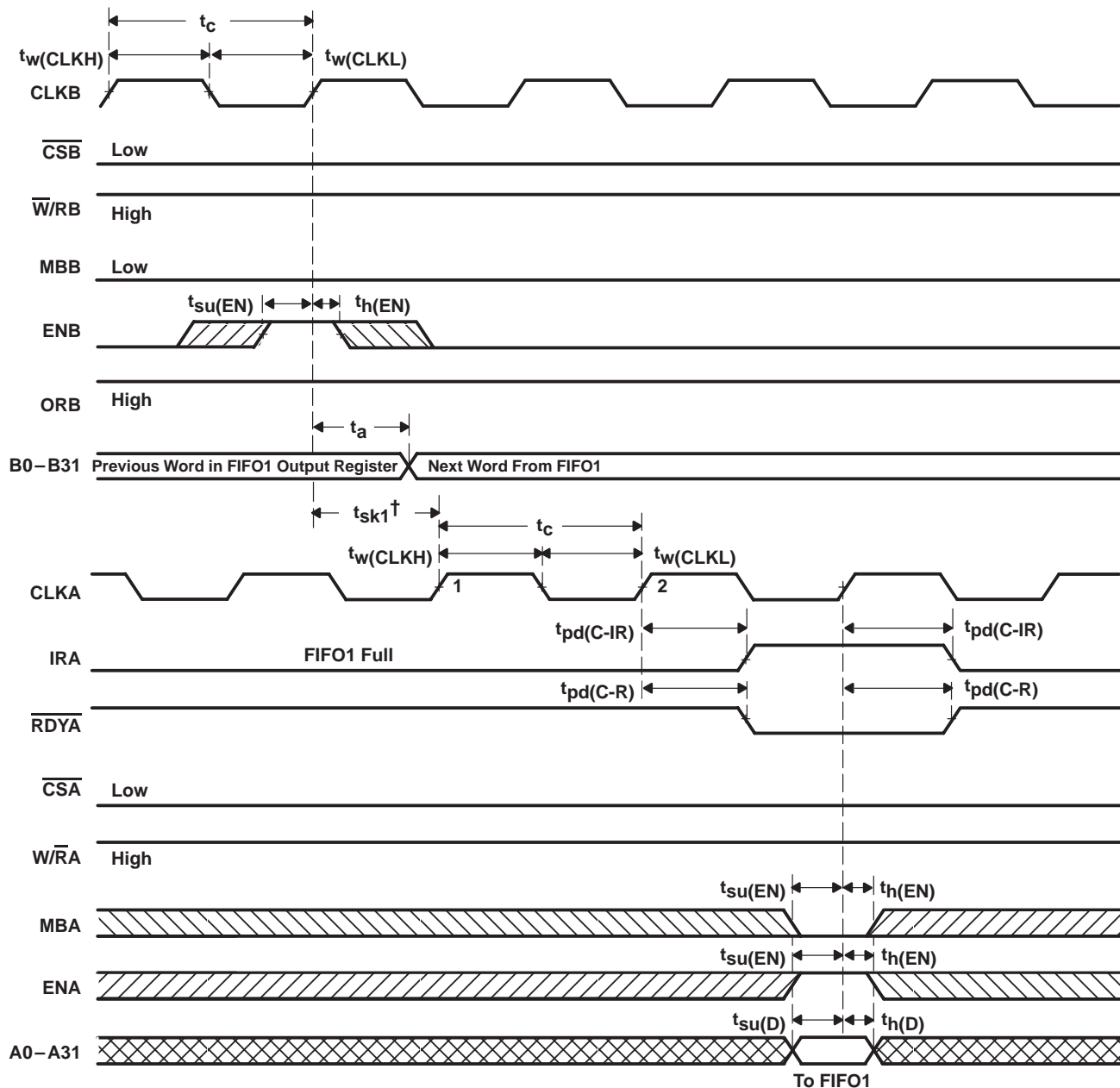

†  $t_{sk1}$  is the minimum time between a rising CLKB edge and a rising CLKA edge for IRA to transition high in the next CLKA cycle. If the time between the rising CLKB edge and rising CLKA edge is less than  $t_{sk1}$ , then IRA may transition high one CLKA cycle later than shown.

Figure 9. IRA-Flag Timing and First Available Write When FIFO1 Is Full

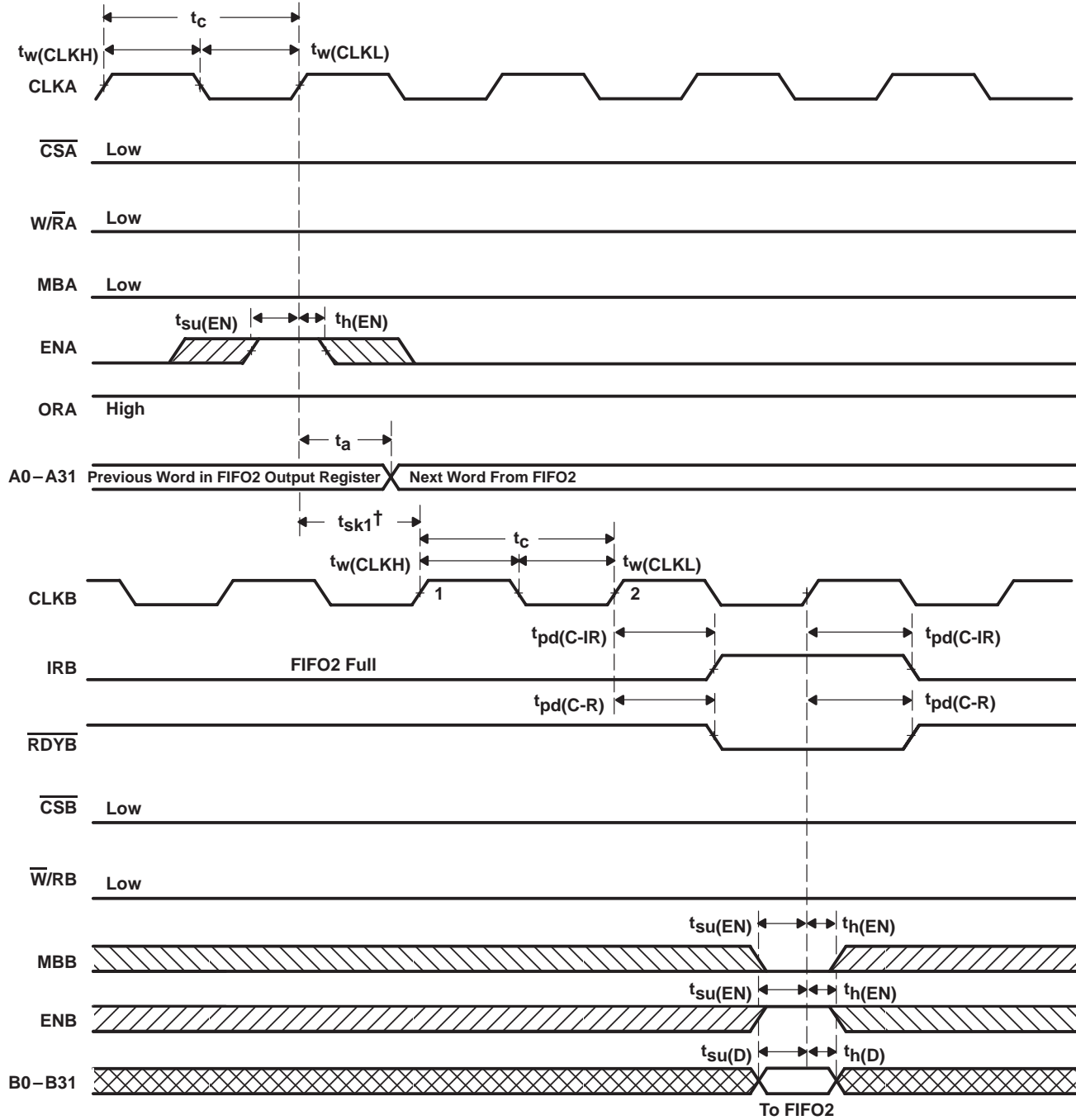

<sup>†</sup>  $t_{sk1}$  is the minimum time between a rising CLKA edge and a rising CLKB edge for IRB to transition high in the next CLKB cycle. If the time between the rising CLKA edge and rising CLKB edge is less than  $t_{sk1}$ , then IRB may transition high one CLKB cycle later than shown.

Figure 10. IRB-Flag Timing and First Available Write When FIFO2 Is Full

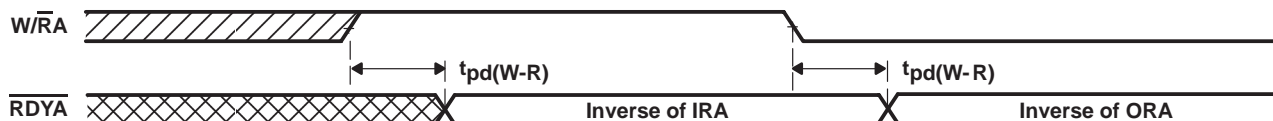

Figure 11.  $\overline{W/RA}$  to  $\overline{RDYA}$  Timing

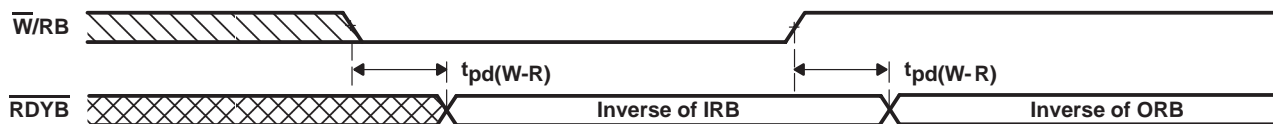
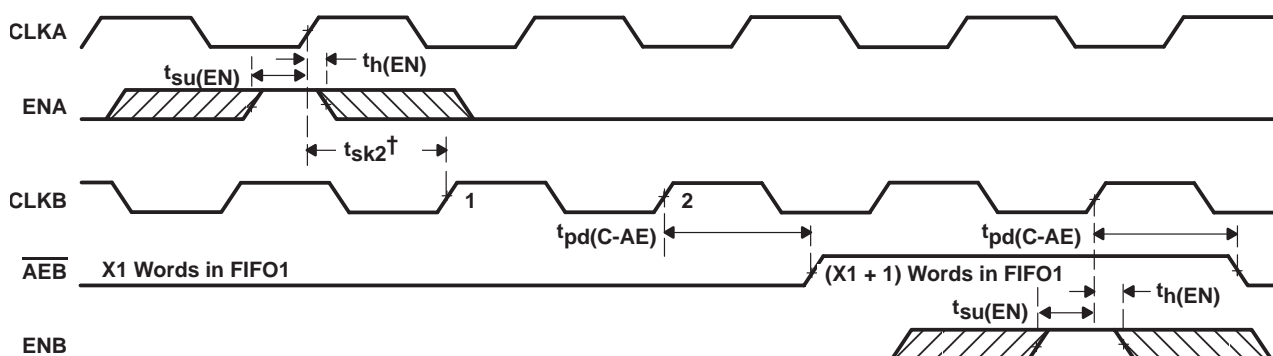

Figure 12.  $\overline{W/RB}$  to  $\overline{RDYB}$  Timing



†  $t_{sk2}$  is the minimum time between a rising CLKA edge and a rising CLKB edge for  $\overline{AEB}$  to transition high in the next CLKB cycle. If the time between the rising CLKA edge and rising CLKB edge is less than  $t_{sk2}$ , then  $\overline{AEB}$  may transition high one CLKB cycle later than shown.

NOTE A: FIFO1 write ( $\overline{CSA} = L, \overline{W/RA} = H, \overline{MBA} = L$ ), FIFO1 read ( $\overline{CSB} = L, \overline{W/RB} = H, \overline{MBB} = L$ ). Data in the FIFO1 output register has been read from the FIFO.

Figure 13. Timing for  $\overline{AEB}$  When FIFO1 Is Almost Empty

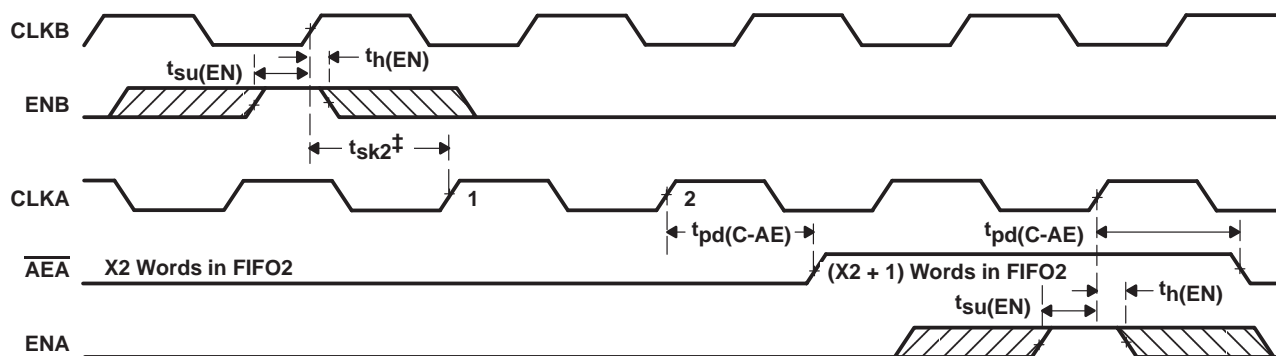

‡  $t_{sk2}$  is the minimum time between a rising CLKB edge and a rising CLKA edge for  $\overline{AEA}$  to transition high in the next CLKA cycle. If the time between the rising CLKB edge and rising CLKA edge is less than  $t_{sk2}$ , then  $\overline{AEA}$  may transition high one CLKA cycle later than shown.

NOTE A: FIFO2 write ( $\overline{CSB} = L, \overline{W/RB} = L, \overline{MBB} = L$ ), FIFO2 read ( $\overline{CSA} = L, \overline{W/RA} = L, \overline{MBA} = L$ ). Data in the FIFO2 output register has been read from the FIFO.

Figure 14. Timing for  $\overline{AEA}$  When FIFO2 Is Almost Empty

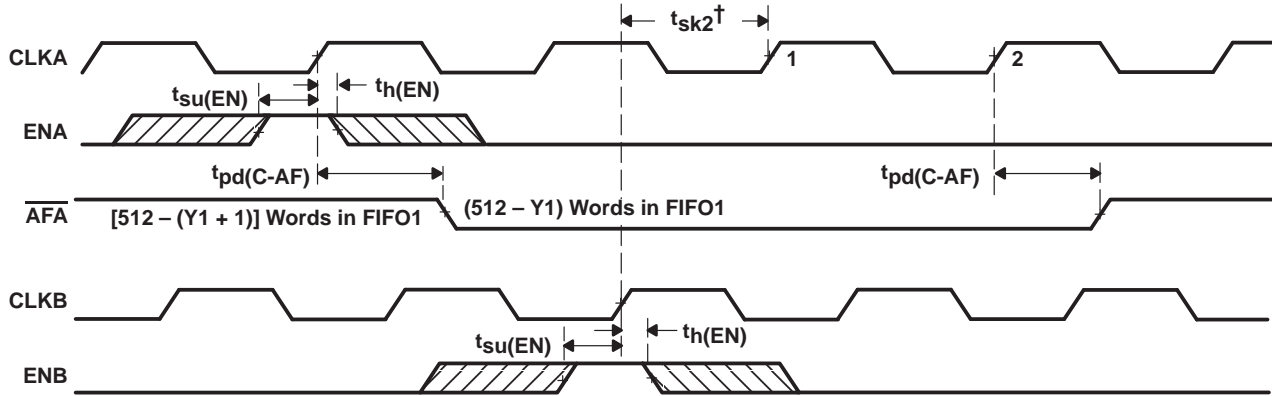

†  $t_{sk2}$  is the minimum time between a rising CLKA edge and a rising CLKB edge for  $\overline{AFA}$  to transition high in the next CLKA cycle. If the time between the rising CLKA edge and rising CLKB edge is less than  $t_{sk2}$ , then  $\overline{AFA}$  may transition high one CLKB cycle later than shown.

NOTE A: FIFO1 write ( $\overline{CSA} = L, \overline{W}/\overline{RA} = H, \overline{MBA} = L$ ), FIFO1 read ( $\overline{CSB} = L, \overline{W}/\overline{RB} = H, \overline{MBB} = L$ ). Data in the FIFO1 output register has been read from the FIFO.

Figure 15. Timing for  $\overline{AFA}$  When FIFO1 Is Almost Full

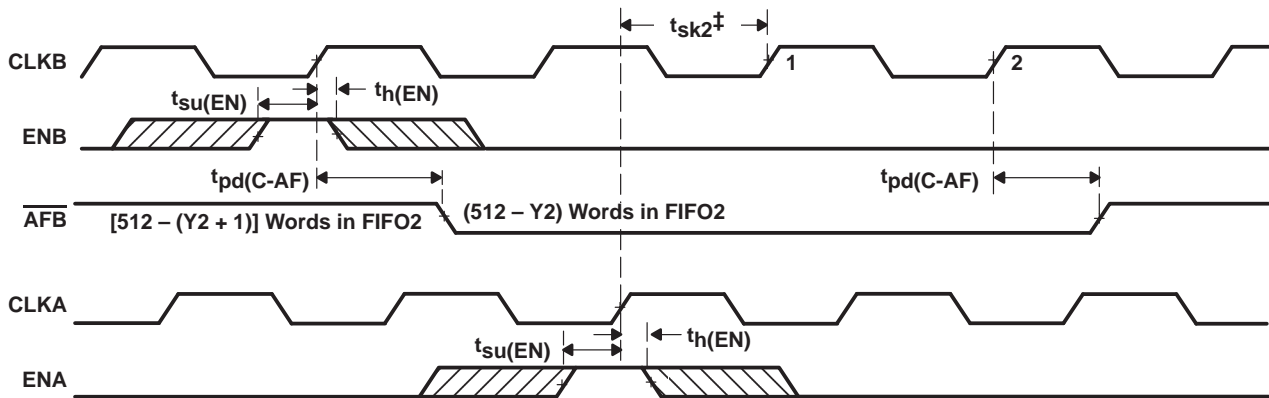

‡  $t_{sk2}$  is the minimum time between a rising CLKB edge and a rising CLKA edge for  $\overline{AFB}$  to transition high in the next CLKB cycle. If the time between the rising CLKB edge and rising CLKA edge is less than  $t_{sk2}$ , then  $\overline{AFB}$  may transition high one CLKA cycle later than shown.

NOTE A: FIFO2 write ( $\overline{CSB} = L, \overline{W}/\overline{RB} = L, \overline{MBB} = L$ ), FIFO2 read ( $\overline{CSA} = L, \overline{W}/\overline{RA} = L, \overline{MBA} = L$ ). Data in the FIFO2 output register has been read from the FIFO.

Figure 16. Timing for  $\overline{AFB}$  When FIFO2 Is Almost Full

CLOCKED BIDIRECTIONAL FIRST-IN, FIRST-OUT MEMORY

SCAS228D – JUNE 1992 – REVISED APRIL 1998

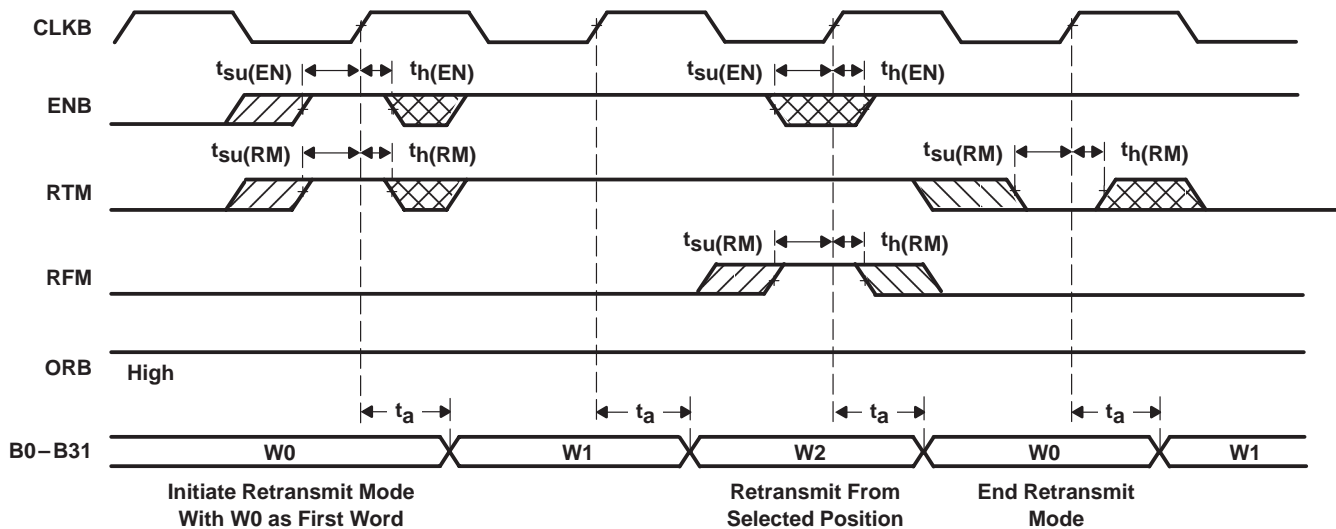

NOTE A:  $\overline{CSB} = L$ ,  $\overline{W/RB} = H$ ,  $MBB = L$ . No input enables other than RTM and RFM are needed to control retransmit mode or begin a retransmit. Other enables are shown only to relate retransmit operations to the FIFO1 output register.

Figure 17. FIFO1 Retransmit Timing Showing Minimum Retransmit Length

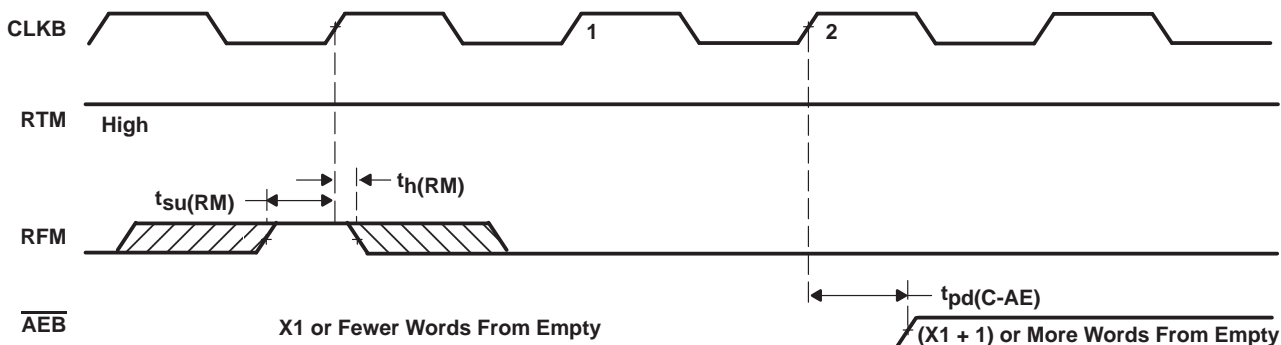

NOTE A:  $X1$  is the value loaded in the almost-full flag offset register.

Figure 18.  $\overline{AEB}$  Maximum Latency When Retransmit Increases the Number of Stored Words Above  $X1$

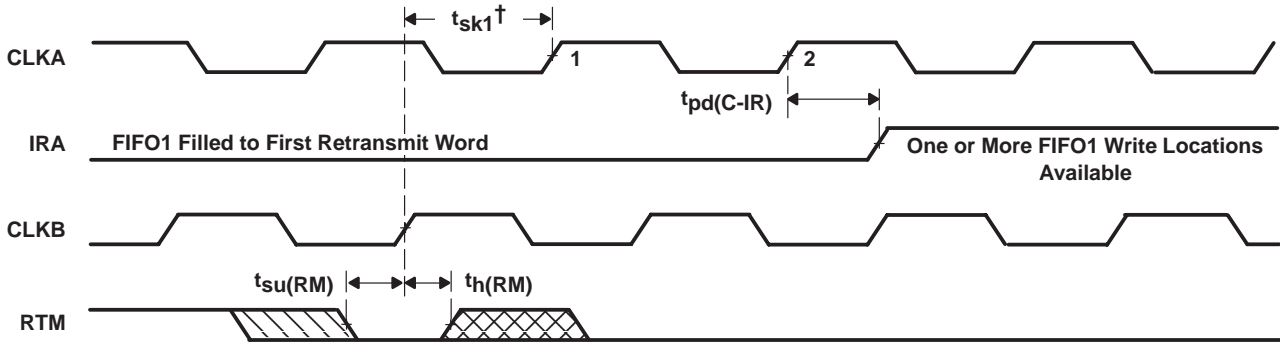

$^\dagger t_{sk1}$  is the minimum time between a rising CLKB edge and a rising CLKA edge for IRA to transition high in the next CLKA cycle. If the time between the rising CLKB edge and rising CLKA edge is less than  $t_{sk1}$ , then IRA may transition high one CLKA cycle later than shown.

**Figure 19. IRA Timing From the End of Retransmit Mode When One or More FIFO1 Write Locations Are Available**

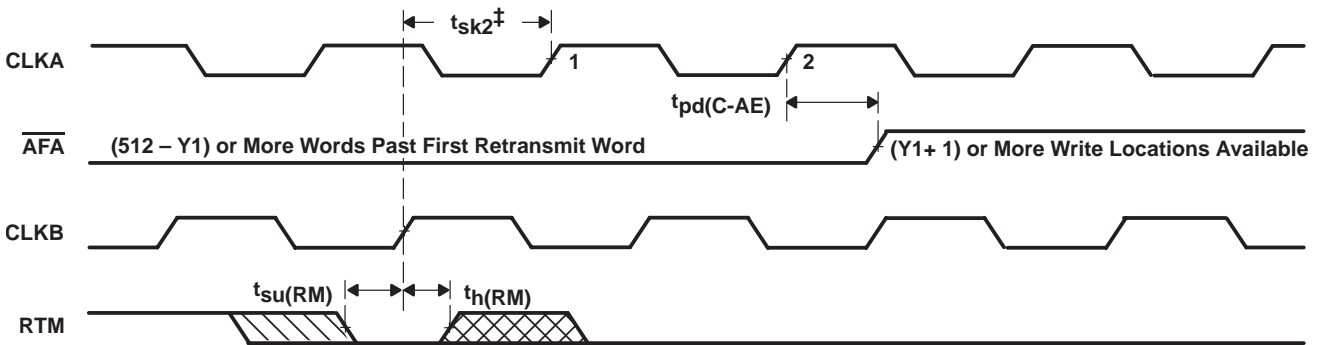

$^\ddagger t_{sk2}$  is the minimum time between a rising CLKB edge and a rising CLKA edge for  $\overline{AFA}$  to transition high in the next CLKA cycle. If the time between the rising CLKB edge and rising CLKA edge is less than  $t_{sk2}$ , then  $\overline{AFA}$  may transition high one CLKA cycle later than shown.

NOTE A: Y is the value loaded in the almost-full flag offset register.

**Figure 20.  $\overline{AFA}$  Timing From the End of Retransmit Mode When (Y1 + 1) or More FIFO1 Write Locations Are Available**



CLOCKED BIDIRECTIONAL FIRST-IN, FIRST-OUT MEMORY

SCAS228D – JUNE 1992 – REVISED APRIL 1998

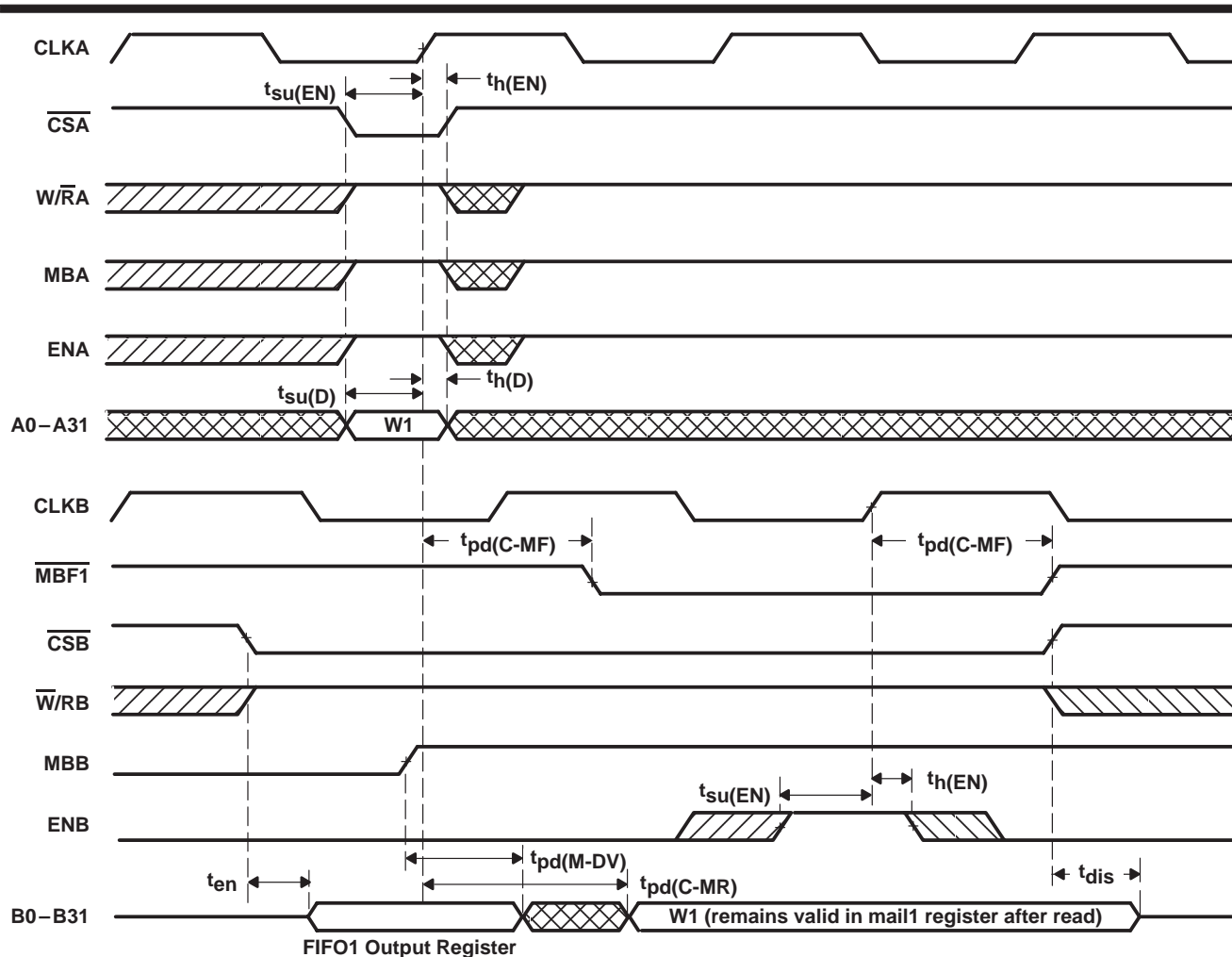

Figure 21. Timing for Mail1 Register and  $\overline{\text{MBF1}}$  Flag

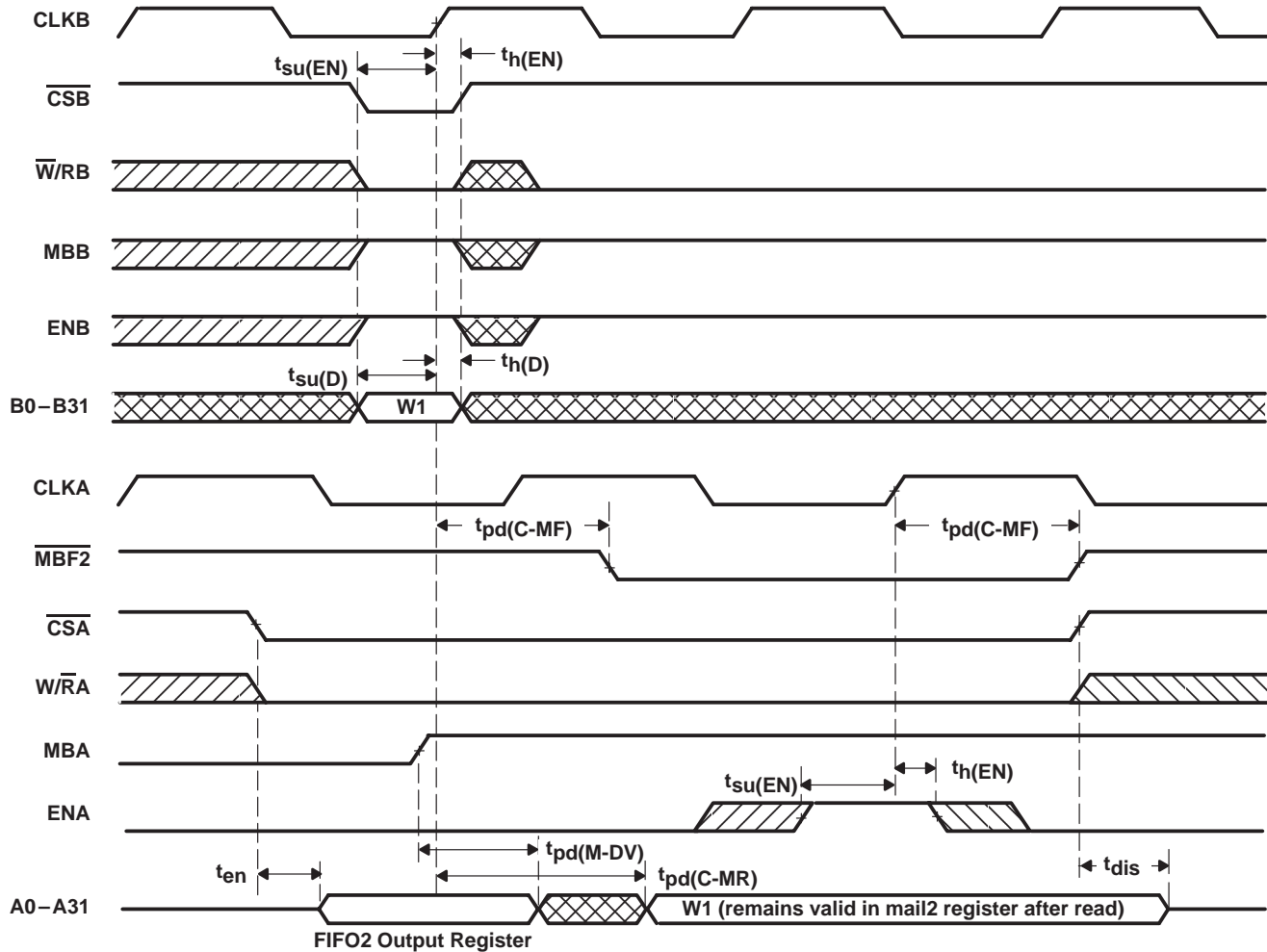

Figure 22. Timing for Mail2 Register and  $\overline{\text{MBF2}}$  Flag

absolute maximum ratings over operating free-air temperature range (unless otherwise noted)†

Supply voltage range, $V_{CC}$ .....	-0.5 V to 7 V
Input voltage range, $V_I$ (see Note 1) .....	-0.5 V to $V_{CC} + 0.5$ V
Output voltage range, $V_O$ (see Note 1) .....	-0.5 V to $V_{CC} + 0.5$ V
Input clamp current, $I_{IK}$ ( $V_I < 0$ or $V_I > V_{CC}$ ) .....	±20 mA
Output clamp current, $I_{OK}$ ( $V_O < 0$ or $V_O > V_{CC}$ ) .....	±50 mA
Continuous output current, $I_O$ ( $V_O = 0$ to $V_{CC}$ ) .....	±50 mA
Continuous current through $V_{CC}$ or GND .....	±400 mA
Package thermal impedance, $\theta_{JA}$ (see Note 2): PCB package .....	28°C/W
..... PQ package .....	46°C/W
Storage temperature range, $T_{stg}$ .....	-65°C to 150°C

† Stresses beyond those listed under “absolute maximum ratings” may cause permanent damage to the device. These are stress ratings only, and functional operation of the device at these or any other conditions beyond those indicated under “recommended operating conditions” is not implied. Exposure to absolute-maximum-rated conditions for extended periods may affect device reliability.

- NOTES: 1. The input and output voltage ratings may be exceeded provided the input and output current ratings are observed.  
 2. The package thermal impedance is calculated in accordance with JESD 51.

## CLOCKED BIDIRECTIONAL FIRST-IN, FIRST-OUT MEMORY

SCAS228D – JUNE 1992 – REVISED APRIL 1998

## recommended operating conditions

		MIN	MAX	UNIT
V <sub>CC</sub>	Supply voltage	4.5	5.5	V
V <sub>IH</sub>	High-level input voltage	2		V
V <sub>IL</sub>	Low-level input voltage		0.8	V
I <sub>OH</sub>	High-level output current		-4	mA
I <sub>OL</sub>	Low-level output current		8	mA
T <sub>A</sub>	Operating free-air temperature	0	70	°C

## electrical characteristics over recommended operating free-air temperature range (unless otherwise noted)

PARAMETER	TEST CONDITIONS		MIN	TYP†	MAX	UNIT
V <sub>OH</sub>	V <sub>CC</sub> = 4.5 V,	I <sub>OH</sub> = -4 mA	2.4			V
V <sub>OL</sub>	V <sub>CC</sub> = 4.5 V,	I <sub>OL</sub> = 8 mA			0.5	V
I <sub>I</sub>	V <sub>CC</sub> = 5.5 V,	V <sub>I</sub> = V <sub>CC</sub> or 0			±5	μA
I <sub>OZ</sub>	V <sub>CC</sub> = 5.5 V,	V <sub>O</sub> = V <sub>CC</sub> or 0			±5	μA
I <sub>CC</sub>	V <sub>CC</sub> = 5.5 V,	V <sub>I</sub> = V <sub>CC</sub> - 0.2 V or 0			400	μA
ΔI <sub>CC</sub> ‡	V <sub>CC</sub> = 5.5 V, One input at 3.4 V, Other inputs at V <sub>CC</sub> or GND	$\overline{\text{CSA}} = V_{IH}$	A0-A31	0		mA
		$\overline{\text{CSB}} = V_{IH}$	B0-B31	0		
		$\overline{\text{CSA}} = V_{IL}$	A0-A31		1	
		$\overline{\text{CSB}} = V_{IL}$	B0-B31		1	
		All other inputs			1	
C <sub>i</sub>	V <sub>I</sub> = 0,	f = 1 MHz		4		pF
C <sub>o</sub>	V <sub>O</sub> = 0,	f = 1 MHz		8		pF

† All typical values are at V<sub>CC</sub> = 5 V, T<sub>A</sub> = 25°C.‡ This is the supply current when each input is at one of the specified TTL voltage levels rather than 0 V or V<sub>CC</sub>.

## CLOCKED BIDIRECTIONAL FIRST-IN, FIRST-OUT MEMORY

SCAS228D – JUNE 1992 – REVISED APRIL 1998

timing requirements over recommended ranges of supply voltage and operating free-air temperature (see Figures 1 through 23)

		'ACT3638-15		'ACT3638-20		'ACT3638-30		UNIT
		MIN	MAX	MIN	MAX	MIN	MAX	
$f_{\text{clock}}$	Clock frequency, CLKA or CLKB	66.7		50		33.4		MHz
$t_c$	Clock cycle time, CLKA or CLKB	15		20		30		ns
$t_w(\text{CLKH})$	Pulse duration, CLKA and CLKB high	6		8		10		ns
$t_w(\text{CLKL})$	Pulse duration, CLKA and CLKB low	6		8		10		ns
$t_{\text{su}}(\text{D})$	Setup time, A0–A31 before CLKA $\uparrow$ and B0–B31 before CLKB $\uparrow$	4.5		5		6		ns
$t_{\text{su}}(\text{EN})$	Setup time, $\overline{\text{CSA}}$ , $\overline{\text{W/RA}}$ , ENA, and MBA before CLKA $\uparrow$ ; $\overline{\text{CSB}}$ , $\overline{\text{W/RB}}$ , ENB, and MBB before CLKB $\uparrow$	5		6		7		ns
$t_{\text{su}}(\text{RM})$	Setup time, RTM and RFM before CLKB $\uparrow$	6		6.5		7		ns
$t_{\text{su}}(\text{RS})$	Setup time, $\overline{\text{RST1}}$ or $\overline{\text{RST2}}$ low before CLKA $\uparrow$ or CLKB $\uparrow$	5		6		7		ns
$t_{\text{su}}(\text{FS})$	Setup time, FS0 and FS1 before $\overline{\text{RST1}}$ and $\overline{\text{RST2}}$ high	7		8		9		ns
$t_{\text{h}}(\text{D})$	Hold time, A0–A31 after CLKA $\uparrow$ and B0–B31 after CLKB $\uparrow$	0		0		0		ns
$t_{\text{h}}(\text{EN})$	Hold time, $\overline{\text{CSA}}$ , $\overline{\text{W/RA}}$ , ENA, and MBA after CLKA $\uparrow$ ; $\overline{\text{CSB}}$ , $\overline{\text{W/RB}}$ , ENB, and MBB after CLKB $\uparrow$	0		0		0		ns
$t_{\text{h}}(\text{RM})$	Hold time, RTM and RFM after CLKB $\uparrow$	0		0		0		ns
$t_{\text{h}}(\text{RS})$	Hold time, $\overline{\text{RST1}}$ or $\overline{\text{RST2}}$ low after CLKA $\uparrow$ or CLKB $\uparrow$	4		4		5		ns
$t_{\text{h}}(\text{FS})$	Hold time, FS0 and FS1 after $\overline{\text{RST1}}$ and $\overline{\text{RST2}}$ high	2		3		3		ns
$t_{\text{sk1}}^\ddagger$	Skew time between CLKA $\uparrow$ and CLKB $\uparrow$ for ORA, ORB, IRA, and IRB	8		9		11		ns
$t_{\text{sk2}}^\ddagger$	Skew time between CLKA $\uparrow$ and CLKB $\uparrow$ for $\overline{\text{AEA}}$ , $\overline{\text{AEB}}$ , $\overline{\text{AFA}}$ , and $\overline{\text{AFB}}$	12		16		20		ns

$^\ddagger$  Requirement to count the clock edge as one of at least four needed to reset a FIFO

$^\ddagger$  Skew time is not a timing constraint for proper device operation and is included only to illustrate the timing relationship between CLKA cycle and CLKB cycle.

## CLOCKED BIDIRECTIONAL FIRST-IN, FIRST-OUT MEMORY

SCAS228D – JUNE 1992 – REVISED APRIL 1998

switching characteristics over recommended ranges of supply voltage and operating free-air temperature,  $C_L = 30$  pF (see Figures 1 through 23)

PARAMETER	'ACT3638-15		'ACT3638-20		'ACT3638-30		UNIT
	MIN	MAX	MIN	MAX	MIN	MAX	
$f_{max}$	66.7		50		33.4		MHz
$t_a$	Access time, $CLKA\uparrow$ to A0–A31 and $CLKB\uparrow$ to B0–B31						
$t_{pd}(C-IR)$	Propagation delay time, $CLKA\uparrow$ to IRA and $CLKB\uparrow$ to IRB						
$t_{pd}(C-OR)$	Propagation delay time, $CLKA\uparrow$ to ORA and $CLKB\uparrow$ to ORB						
$t_{pd}(C-R)$	Propagation delay time, $CLKA\uparrow$ to $\overline{RDYA}$ and $CLKB\uparrow$ to $\overline{RDYB}$						
$t_{pd}(W-R)$	Propagation delay time, $\overline{W/RA}$ to $\overline{RDYA}$ and $\overline{W/RB}$ to $\overline{RDYB}$						
$t_{pd}(C-AE)$	Propagation delay time, $CLKA\uparrow$ to $\overline{AEA}$ and $CLKB\uparrow$ to $\overline{AEB}$						
$t_{pd}(C-AF)$	Propagation delay time, $CLKA\uparrow$ to $\overline{AFA}$ and $CLKB\uparrow$ to $\overline{AFB}$						
$t_{pd}(C-MF)$	Propagation delay time, $CLKA\uparrow$ to $\overline{MBF1}$ low or $\overline{MBF2}$ high and $CLKB\uparrow$ to $\overline{MBF2}$ low or $\overline{MBF1}$ high						
$t_{pd}(C-MR)$	Propagation delay time, $CLKA\uparrow$ to B0–B31 $\uparrow$ and $CLKB\uparrow$ to A0–A31 $\ddagger$						
$t_{pd}(M-DV)$	Propagation delay time, MBA to A0–A31 valid and MBB to B0–B31 valid						
$t_{pd}(R-F)$	Propagation delay time, $\overline{RST1}$ low to $\overline{AEB}$ low, $\overline{AFA}$ high, and $\overline{MBF1}$ high, and $\overline{RST2}$ low to $\overline{AEA}$ low, $\overline{AFB}$ high, and $\overline{MBF2}$ high						
$t_{en}$	Enable time, $\overline{CSA}$ and $\overline{W/RA}$ low to A0–A31 active and $\overline{CSB}$ low and $\overline{W/RB}$ high to B0–B31 active						
$t_{dis}$	Disable time, $\overline{CSA}$ or $\overline{W/RA}$ high to A0–A31 at high impedance and $\overline{CSB}$ high or $\overline{W/RB}$ low to B0–B31 at high impedance						

$\uparrow$  Writing data to the mail1 register when the B0–B31 outputs are active and MBB is high

$\ddagger$  Writing data to the mail2 register when the A0–A31 outputs are active and MBA is high

PARAMETER MEASUREMENT INFORMATION

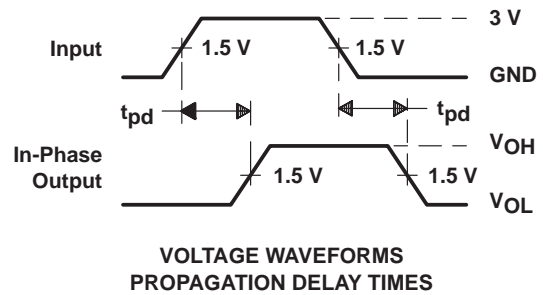
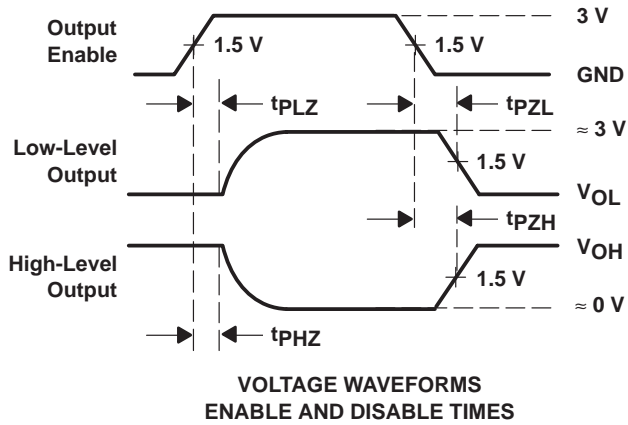
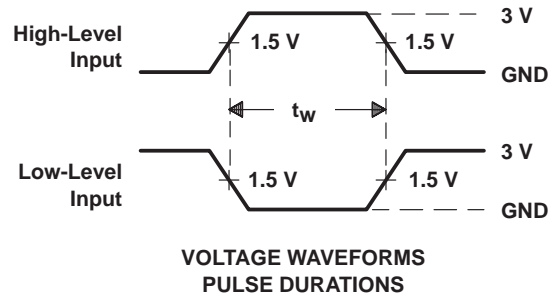
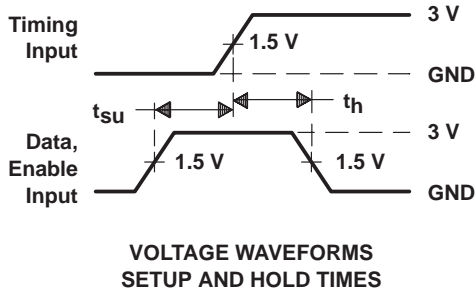
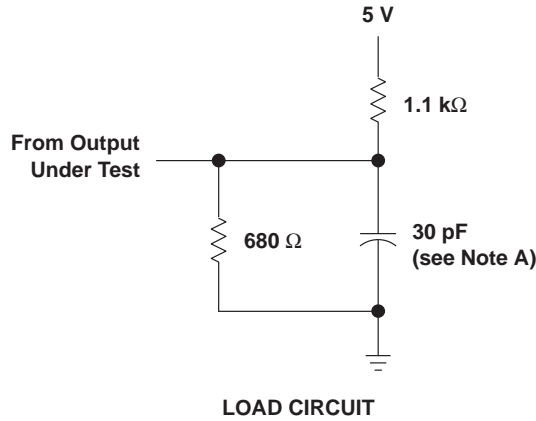

NOTE A: Includes probe and jig capacitance

Figure 23. Load Circuit and Voltage Waveforms

## TYPICAL CHARACTERISTICS

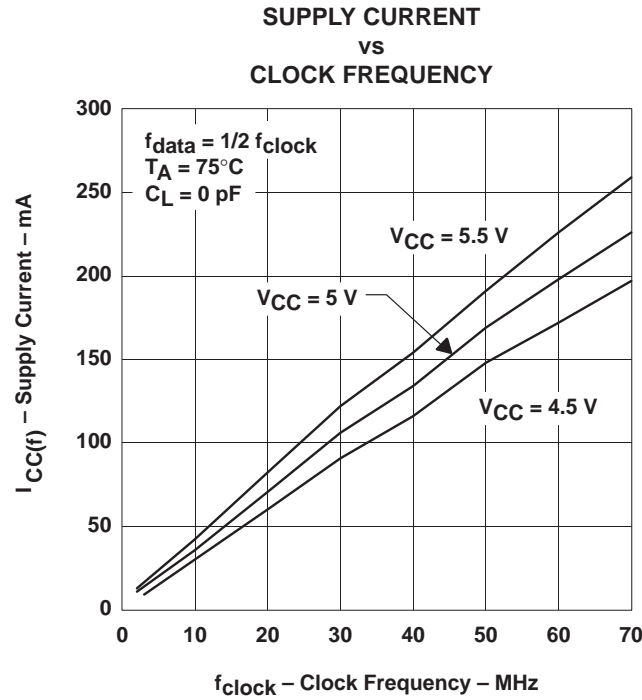

Figure 24



## **IMPORTANT NOTICE**

Texas Instruments and its subsidiaries (TI) reserve the right to make changes to their products or to discontinue any product or service without notice, and advise customers to obtain the latest version of relevant information to verify, before placing orders, that information being relied on is current and complete. All products are sold subject to the terms and conditions of sale supplied at the time of order acknowledgement, including those pertaining to warranty, patent infringement, and limitation of liability.

TI warrants performance of its semiconductor products to the specifications applicable at the time of sale in accordance with TI's standard warranty. Testing and other quality control techniques are utilized to the extent TI deems necessary to support this warranty. Specific testing of all parameters of each device is not necessarily performed, except those mandated by government requirements.

**CERTAIN APPLICATIONS USING SEMICONDUCTOR PRODUCTS MAY INVOLVE POTENTIAL RISKS OF DEATH, PERSONAL INJURY, OR SEVERE PROPERTY OR ENVIRONMENTAL DAMAGE ("CRITICAL APPLICATIONS"). TI SEMICONDUCTOR PRODUCTS ARE NOT DESIGNED, AUTHORIZED, OR WARRANTED TO BE SUITABLE FOR USE IN LIFE-SUPPORT DEVICES OR SYSTEMS OR OTHER CRITICAL APPLICATIONS. INCLUSION OF TI PRODUCTS IN SUCH APPLICATIONS IS UNDERSTOOD TO BE FULLY AT THE CUSTOMER'S RISK.**

In order to minimize risks associated with the customer's applications, adequate design and operating safeguards must be provided by the customer to minimize inherent or procedural hazards.

TI assumes no liability for applications assistance or customer product design. TI does not warrant or represent that any license, either express or implied, is granted under any patent right, copyright, mask work right, or other intellectual property right of TI covering or relating to any combination, machine, or process in which such semiconductor products or services might be or are used. TI's publication of information regarding any third party's products or services does not constitute TI's approval, warranty or endorsement thereof.