

Electroluminescent Lamp Driver Dual Oscillators

- DC to AC Inverter for EL Backlit Display Panels
- 2.2V - 5.0V Battery Operation
- Dual Oscillator Operation for Application Flexibility
- Low Current Standby Mode

APPLICATIONS

- PDAs
- Cellular Phones
- Remote Controls
- Hand Held Computers



DESCRIPTION

The **SP4424** is a high voltage output DC-AC converter that can operate from a single battery supply voltage as low as 2.2V. The **SP4424** is capable of supplying up to 220 V_{PP} signals, making it ideal for driving electroluminescent lamps. The device features 5μA (maximum) standby current, for use in low power portable products. An inductor is used to generate high voltage pulses, and two external capacitors are used to select the inductor and the lamp oscillator frequencies. The **SP4424** is offered in both an 8-pin narrow SOIC and 8-pin micro SOIC packages. For delivery in die form, please consult the factory.

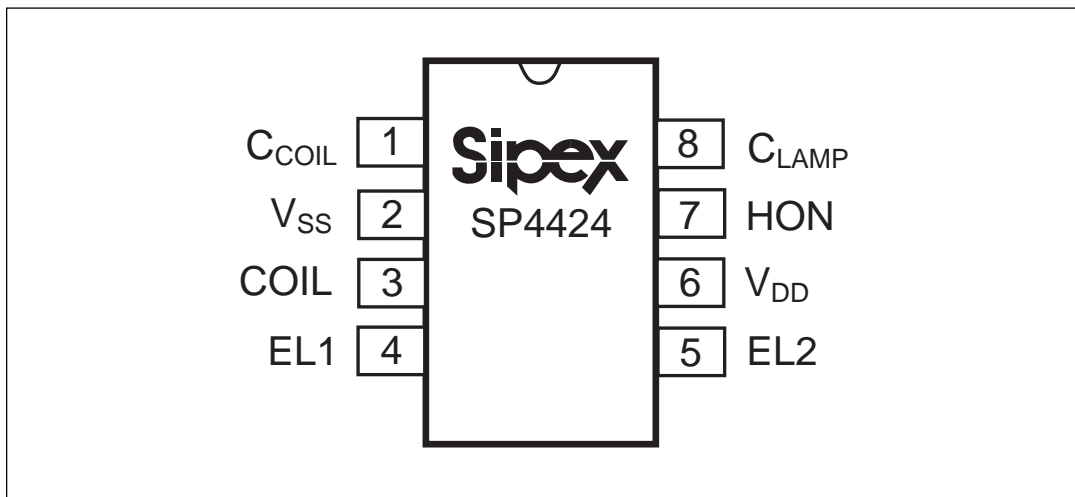

SP4424 Block Diagram

ABSOLUTE MAXIMUM RATINGS

These are stress ratings only and functional operation of the device at these ratings or any other above those indicated in the operation sections of the specifications below is not implied. Exposure to absolute maximum rating conditions for extended periods of time may affect reliability.

V_{DD}	7.0
V Input Voltages/Currents	
HON (pin1).....	-0.5V to ($V_{DD}+0.5V$)
COIL (pin3).....	60mA
Lamp Outputs.....	230V _{pp}
Storage Temperature.....	-65°C to +150°C

Power Dissipation Per Package

8-pin NSOIC (derate 6.14mW/°C above +70°C).....	500mW
8-pin μ SOIC (derate 4.85mW/°C above +70°C).....	390mW

The information furnished herein by Sipex has been carefully reviewed for accuracy and reliability. Its application or use, however, is solely the responsibility of the user. No responsibility for the use of this information is assumed by Sipex, and this information shall not explicitly or implicitly become part of the terms and conditions of any subsequent sales agreement with Sipex. Specifications are subject to change without prior notice. By the sale or transfer of this information, Sipex assumes no responsibility for any infringement of patents or other rights of third parties which may result from its use. No license or other proprietary rights are granted by implication or otherwise under any patent or patent rights of Sipex Corporation.

SPECIFICATIONS

(T = 25°C; V_{DD} = 3.0V; Lamp Load = 55nF; Coil = 5mH at 18 Ohms; Coil OSC = 220pF, Lamp OSC = 1500pF unless otherwise noted)

PARAMETER	MIN.	TYP.	MAX.	UNITS	CONDITIONS
Supply Voltage, V_{DD}	2.2	3.0	5.0	V	
Supply Current, $I_{COIL}+I_{DD}$		35	50	mA	$V_{HON}=3V$
Coil Voltage, V_{COIL}	V_{DD}	.	5.0.	V	
HON Input Voltage, V_{HON} LOW: EL off HIGH: EL on	-0.25 $V_{DD}-0.25$	0 V_{DD}	0.25V $V_{DD}+0.25$	V	
HON Current, EL on			10	μ A	internal pulldown, $V_{HON}=V_{DD}=3V$
Shutdown Current, $I_{SD}=I_{COIL}+I_{DD}$		1	5	μ A	$V_{HON}=0V$
INDUCTOR DRIVE					
Coil Frequency, f_{COIL}	3	4	6	kHz	
Coil Duty Cycle		75		%	
Peak Coil Current, $I_{PK-COIL}$			60	mA	Guaranteed by design.
EL LAMP OUTPUT					
EL Lamp Frequency, f_{LAMP}	150 100	200	250 400	Hz	$T_{AMB}=+25^{\circ}C$ $T_{AMB}=-40^{\circ}C$ to $+85^{\circ}C$
Peak to Peak Output Voltage	60 100 60 120	90 130		V_{PP}	$T_{AMB}=+25^{\circ}C, V_{DD}=2.2V$ $T_{AMB}=+25^{\circ}C, V_{DD}=3.0V$ $T_{AMB}=-40^{\circ}C$ to $+85^{\circ}C, V_{DD}=3.0V$ $T_{AMB}=+25^{\circ}C, V_{DD}=5.0V$

This data sheet specifies environmental parameters, final test conditions and limits as well suggested operating conditions. For applications which require performance beyond the specified conditions and or limits please consult the factory.

Bonding Diagram:

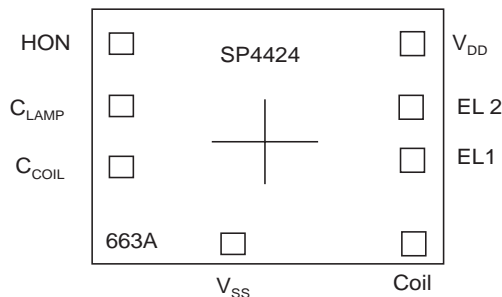

PAD	X	Y
EL1	586.0	187.0
EL2	586.0	-143.0
COIL	586.0	-376.0
V_{SS}	-80.0	-417.0
HON	-562.5	397.0
CAP2	-565.0	-118.0
CAP1	-562.5	114.5
V_{DD}	588.0	417.0

NOTES:

- Dimensions are in Microns unless otherwise noted.
- Bonding pads are 125x125 typical.
- Outside dimensions are maximum, including scribe area.
- Die thickness is 10 mils +/- 1.
- Pad center coordinates are relative to die center.
- Die size 1498 x 1168 (59 x 46 mils).

PIN DESCRIPTION

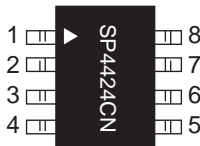

Pin 1 – C_{COIL} - Connect Capacitor from V_{SS} to pin 1 to set coil frequency.

Pin 2 – V_{SS} - Power supply common, connect to ground.

Pin 3 – Coil- Coil input, connect coil from V_{BATTERY} to pin 3.

Pin 4 – EL1- Lamp driver output 1, connect to EL lamp.

Pin 5 – EL2- Lamp driver output 2, connect to EL lamp.

Pin 6 – V_{DD} - Power supply for driver, connect to system V_{DD} .

Pin 7 – HON- Enable for driver operation, high = active; low = inactive.

Pin 8 – C_{LAMP} - connect Capacitor from V_{SS} to pin 8 to set lamp frequency.

THEORY OF OPERATION

The **SP4424** is made up of four basic circuit elements: two precision oscillators, a coil, and the EL driver IC. The oscillators set the coil and lamp frequencies independently. This allows for the selective setting of the coil / lamp frequency ratio. The coil frequency can be selected for maximum energy transfer per cycle for a given coil value. The coil oscillator is designed to operate at 75% duty cycle and the lamp oscillator is designed for 50% DC, for minimum DC offset across the EL lamp.

An external capacitor connected between pin 8 and V_{SS} allows the user to vary the lamp oscillator frequency from approximately 75Hz (4700 pf) to 350Hz (450 pf). Likewise, an external capacitor connected between pin 1 and V_{SS} allows the user to vary the coil oscillator frequency from approximately 5kHz (390 pf) to 50kHz (22 pf). The graphs on **page 7** show the relationship between oscillators (L_{OSC} and C_{OSC}) and their respective capacitor values.

The coil is an external component connected from V_{BATTERY} to pin 3 of the **SP4424**. Energy is stored in the coil according to the equation $E_L = 1/2LI^2$, where I is the peak current flowing in the inductor. The current in the inductor is time dependent and is set by the "ON" time of the coil switch: $I = (V_L / L)t_{\text{ON}}$, where V_L is the voltage across the inductor. At the moment the switch closes, the current in the inductor is zero and the entire supply voltage (minus the V_{SAT} of the switch) is across the inductor. The current in the inductor will then ramp up at a

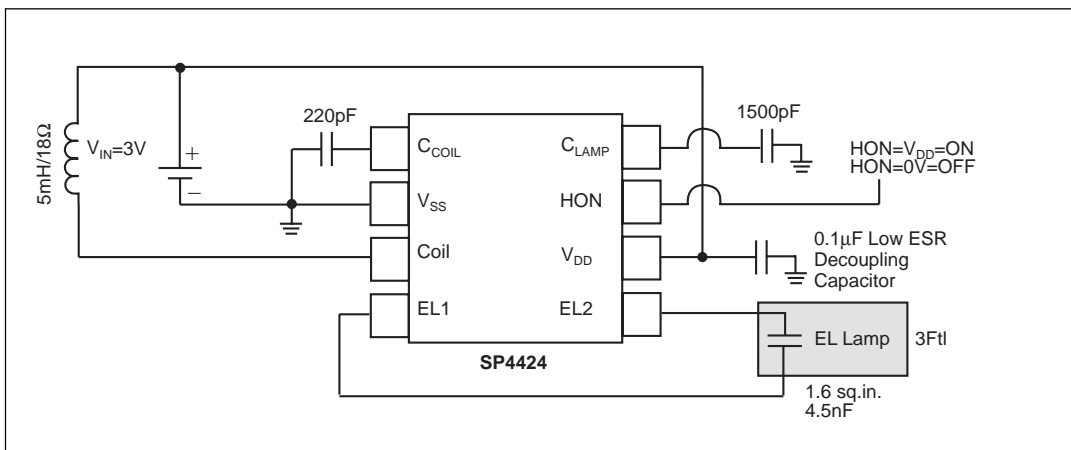

SP4424 Typical Application

linear rate. As the current in the inductor builds up, the voltage across the inductor will decrease due to the resistance of the coil and the "ON" resistance of the switch: $V_L = V_{BATTERY} - I R_L - V_{SAT}$. Since the voltage across the inductor is decreasing, the current ramp-rate also decreases which reduces the current in the coil at the end of t_{ON} the energy stored in the inductor per coil cycle and therefore the light output. The other important issue is that maximum current (saturation current) in the coil is set by the design and manufacturer of the coil. If the parameters of the application such as $V_{BATTERY}$, L , R_L or t_{ON} cause the current in the coil to increase beyond its rated I_{SAT} , excessive heat will be generated and the power efficiency will decrease with no additional light output. The majority of the current goes through the coil and typically less than 3 mA is required for V_{DD} of the **SP4424**. V_{DD} can range from 2.2V to 5V; it is not necessary that $V_{DD} = V_{BATTERY}$. For example, an unregulated voltage source (3.3V) can be directly connected to the coil, while a regulated voltage source (2.85V) can be connected to the IC V_{DD} pin.

Coil performance is also a function of the core material and wire used -- performance variances may be noticeable from different coil suppliers. The Sipex **SP4424** is tested using a 5mH/18Ω coil from Hitachi Metals. For suggested coil sources see [page 9](#).

The f_{COIL} signal controls a switch that connects the end of the coil at pin 3 to ground or to open circuit. The f_{COIL} signal is a 75% duty cycle signal. During the time when the f_{COIL} signal is high, the coil is connected from $V_{BATTERY}$ to ground and a

magnetic field is generated in the coil. During the low part of f_{COIL} , the ground connection is switched open, the field collapses and the voltage generated in the inductor is directed to the high voltage H-bridge switches. f_{COIL} will send as many charge pulses as possible in 1 Lamp Cycle. {Number of Coil pulses in 1 lamp cycle = $\frac{1}{2} \times \frac{Coil\ Freq.}{Lamp\ Freq.}$ } (see [figure 2 on page 6](#)). Each pulse increases the voltage drop across the lamp in discrete steps. As the voltage potential approaches its maximum, the steps become smaller (see [figure 1 on page 6](#)).

The H-bridge consists of two SCR structures that act as high voltage switches. These two switches control the polarity of the lamp (capacitor) as it is charged. The SCR switches are controlled by the f_{LAMP} signal which is the oscillator frequency divided by 2.

When the energy from the coil is released, a high voltage spike is created triggering the SCR switches. The direction of current flow is determined by which SCR is enabled. One full cycle of the H-bridge will create a number of voltage steps from ground to 65V (typical) on pins 4 and 5 which are 180 degrees out of phase (see [figure 3 on page 6](#)). A differential view of the outputs is shown in [figure 4 on page 6](#).

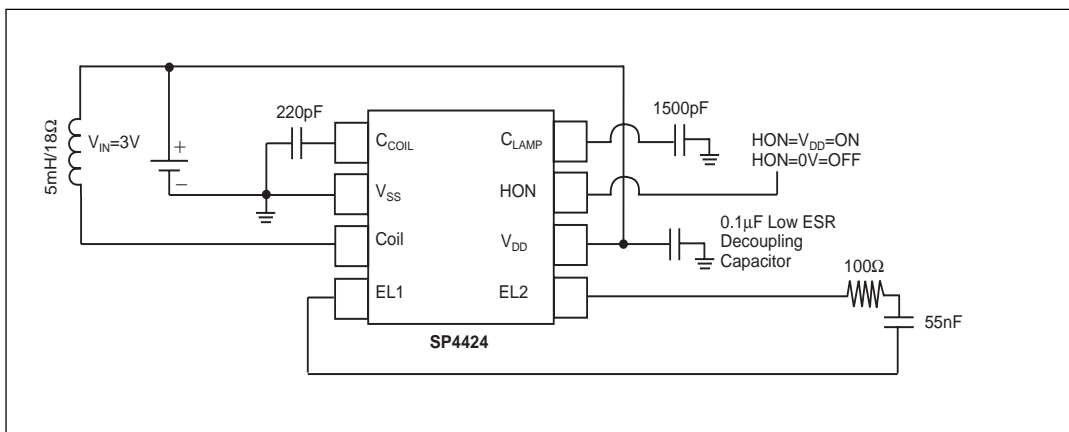

SP4424 Test Circuit

CIRCUIT LAYOUT CONSIDERATIONS:

The **SP4424** IC incorporates two independent asynchronous oscillators, one of which supplies the signal for switching of the coil transistor which generates the coil charge pulses and the other supplies the clock signal to switch the high voltage H-bridge output circuit.

It is necessary to keep all high voltage signals away from these oscillator clock signals as much as possible as crosstalk between the two signals can cause distortion in the EL drive signal which can result in either low light output or blinking of the EL lamp. It is always recommended that a low ESR decoupling capacitor (0.1 μ F or $>$) be used between the V_{DD} (pin 6) and ground (pin 2). The V_{SS} (gnd) pin should in turn be connected to the system ground plane. If it is connected via a circuit trace, this trace should be as short and as wide as possible.

Electroluminescent Technology

What is electroluminescence?

An EL lamp is basically a strip of plastic that is coated with a phosphorous material which emits light (fluoresces) when a high voltage ($>40V$) which was first applied across it, is removed. Long periods of DC voltages applied to the material tend to breakdown the material and reduce its lifetime. With these considerations in mind, the ideal signal to drive an EL lamp is a high voltage sine wave. Traditional approaches to achieving this type of waveform included discrete circuits incorporating a transformer, transistors, and several resistors and capacitors. This approach is large, power hungry, expensive and bulky, and would be difficult to implement in most hand held equipment.

Sipex now offers low power single chip driver circuits specifically designed to drive small to medium sized electroluminescent panels. All that is required is one external inductor and capacitor.

Electroluminescent backlighting is ideal for use with LCD displays, keypads, or other backlit readouts. Its primary use is to illuminate displays in dim to dark conditions for momentary periods of time. EL lamps typically consume less current than LEDs or bulbs making them ideal for battery powered products. Also, EL lamps are able to evenly light an area without creating "hot spots" in the display.

The amount of light emitted is a function of the voltage level applied to the lamp, the frequency at which it is applied and the lamp size and method of construction. There are many variables which can be optimized for specific applications. **Sipex** supplies custom characterization data to aid the designer in selecting the optimum circuit configuration.

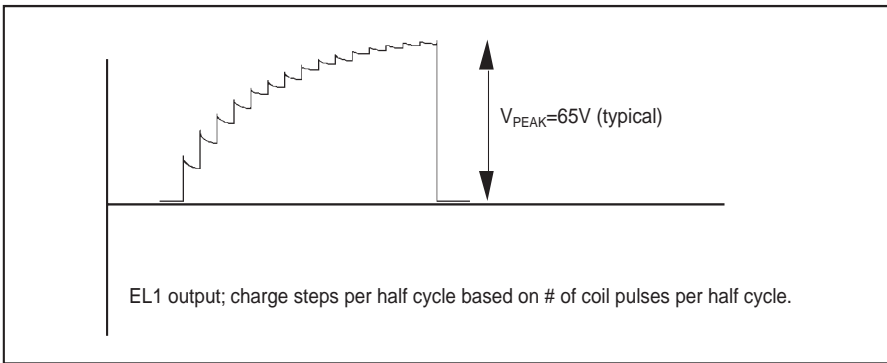

Figure 1. EL output voltage in discrete steps at EL1 output

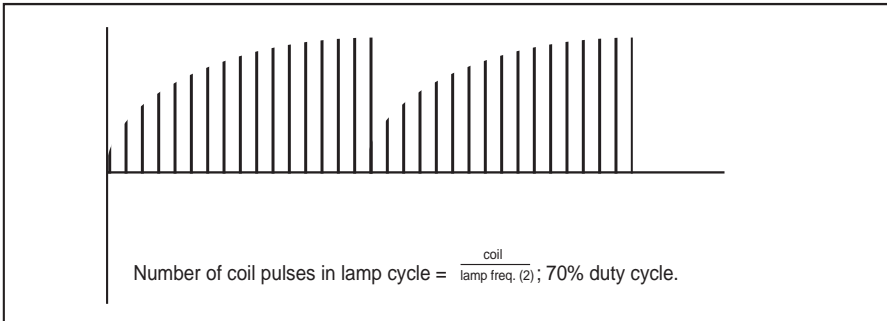

Figure 2. Voltage pulses released from the coil to the EL driver circuitry

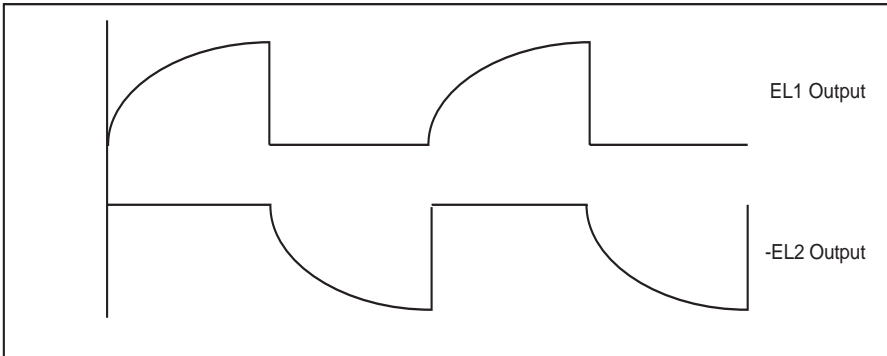

Figure 3. EL voltage waveforms from the EL1 and EL2 outputs

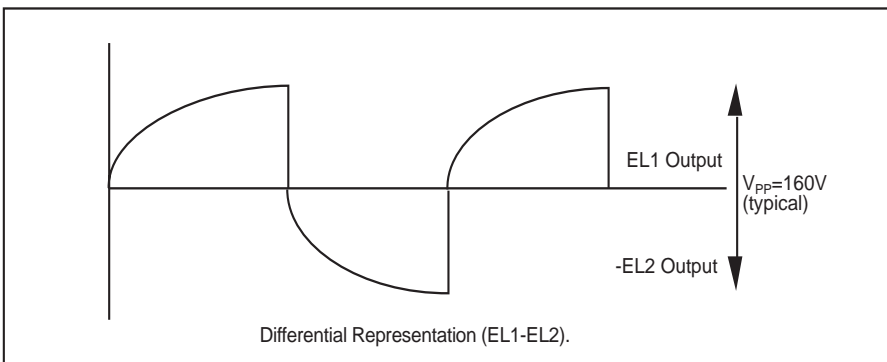
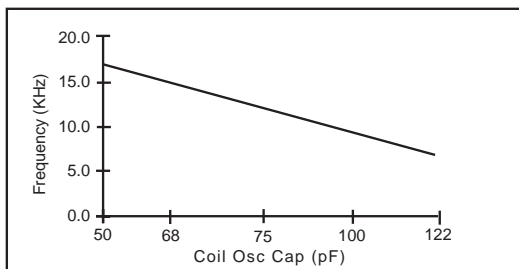
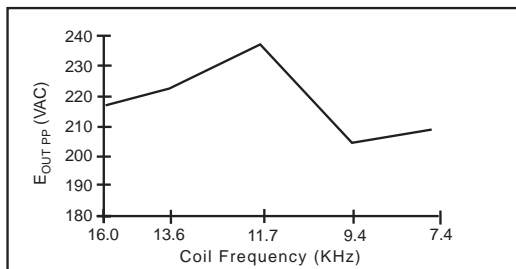

Figure 4. EL differential output waveform of the EL1 and EL2 outputs

The following performance curves are intended to give the designer a relative scale from which to optimize specific applications. Absolute measurements may vary depending upon the brand of components chosen.



Coil Frequency vs. Coil Osc Cap Value



Coil Frequency vs. E_{OUT_PP}

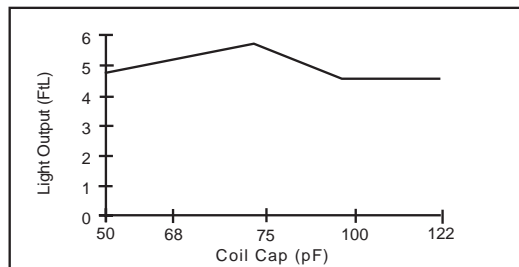

Coil Cap vs. Light Output

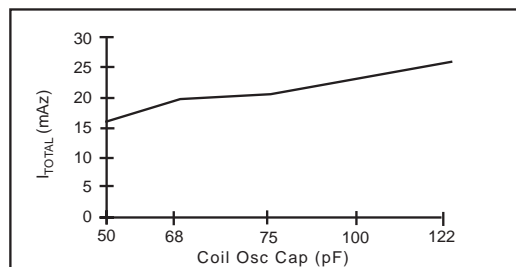

I_{TOTAL} vs. Coil Osc Cap

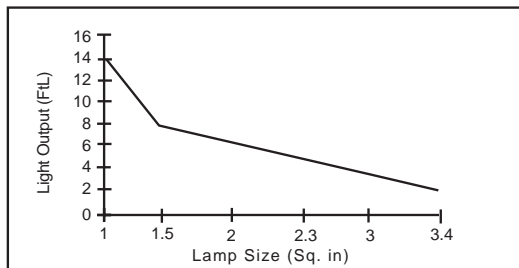

Lamp Size vs. Light Output

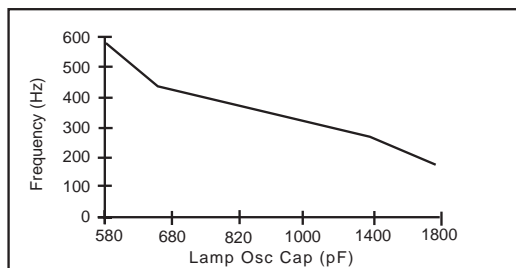

Lamp Frequency vs. Lamp Osc Cap Value

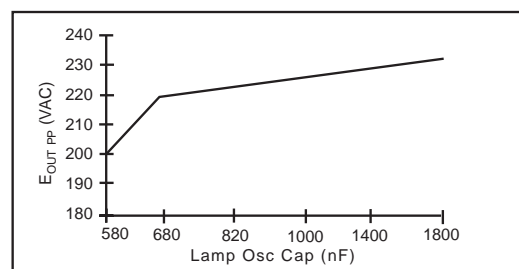

Lamp Osc Cap vs. E_{OUT_PP}

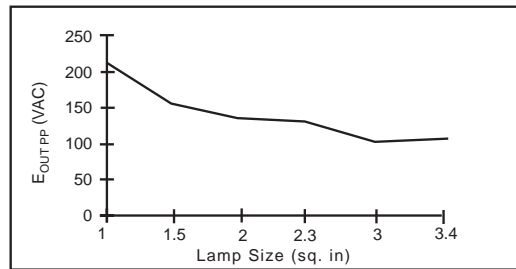

Lamp Size vs. E_{OUT_PP}

The following performance curves are intended to give the designer a relative scale from which to optimize specific applications. Absolute measurements may vary depending upon the brand of components chosen.

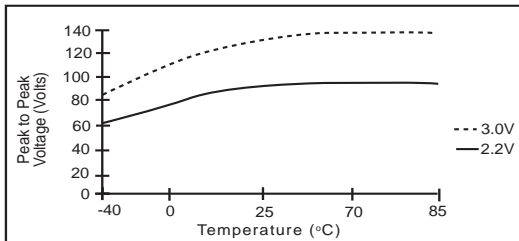

Peak to Peak Voltage vs. Temperature
 $C_{COIL}=220pF$; $C_{LAMP}=1500pF$; $Load=55nF$

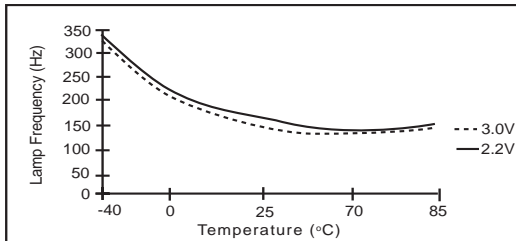

Lamp Frequency vs. Temperature
 $C_{COIL}=220pF$; $C_{LAMP}=1500pF$; $Load=55nF$

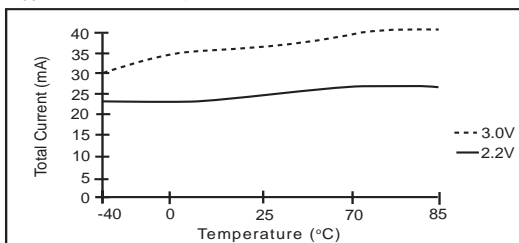

Total Current vs. Temperature
 $C_{COIL}=220pF$; $C_{LAMP}=1500pF$; $Load=55nF$

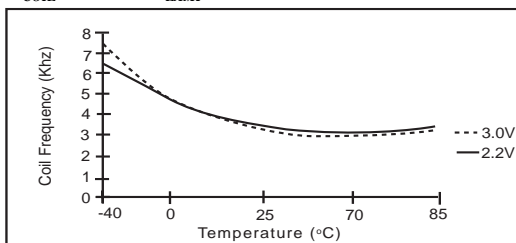

Coil Frequency vs. Temperature
 $C_{COIL}=220pF$; $C_{LAMP}=1500pF$; $Load=55nF$

The coil part numbers presented in this data sheet have been qualified as being suitable for the SP4422A product. Contact Sipex for applications assistance in choosing coil values not listed in this data sheet.

CTC Coils LTD Hong Kong
 Ph: 85-2695-4889
 Fax: 85-2695-1842

Mark Technologies:
 North American Stocking
 distributor for Sankyo and CTC
 Ph: 905-891-0165
 Fax: 905-891-8534

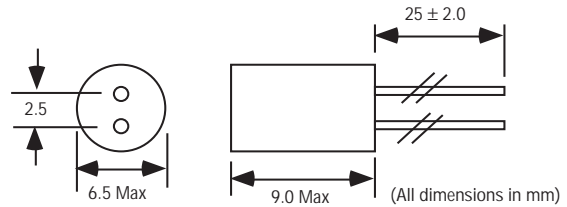

Model Numbers: CH5070AS-203K-006 (20mH, 65Ω)
 Sipex Number: S51208-M-1021-Sipex

HITACHI METALS Ltd. Japan
 Ph: 3-3284-4936
 Fax: 3-3287-1945

HITACHI METALS Hong Kong
 Ph: 852-2724-4183
 Fax: 852-2311-2093

HITACHI METALS Singapore
 Ph: 65-222-3077
 Fax: 65-222-5232

HITACHI METALS Chicago, IL
 Ph: 847-364-7200
 Fax: 847-364-7279

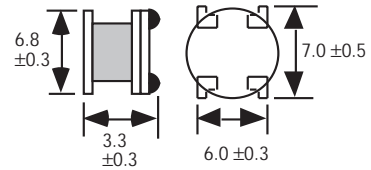

Part Numbers:
 MD735L902B (9mH ± 20% 41Ω)
 MD735L502A (5mH ± 20% 19.8Ω)

Toko Inc. Japan
 Ph: 03-3727-1161
 Fax: 03-3727-1176

Toko Inc. Singapore
 Ph: 255-4000
 Fax: 250-8134

Toko Korea
 Ph: 0551-50-5500
 Fax: 0551-93-1110

Toko America Inc. USA
 Ph: 847-297-0070
 Fax: 847-699-7864

Toko Germany
 Ph: 49-7156-96-060
 Fax: 49-7156-96-06-26

Toko France
 Ph: 01-4557-4465
 Fax: 01-4554-2837

Part Numbers:
 667MA-472N (4.7mH, 13Ω)

Toko U.K.
 Ph: 1753-854057-9
 Fax: 1753-8503-23

Toko Hong Kong
 Ph: 2342-8131
 Fax: 2341-9570

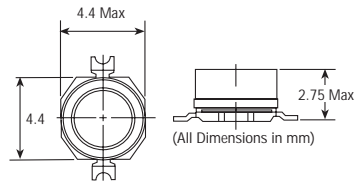

muRata USA
 Ph: 770-436-1300
 Fax: 770-436-3030

muRata Taiwan
 Ph: 88-6429-1415-1
 Fax: 88-6442-5292-9

muRata Hong Kong
 Ph: 85-2237-6389-8
 Fax: 85-2237-5556-55

muRata Europe
 Ph: 49-9116-6870
 Fax: 49-1166-8722-5

muRata Singapore
 Ph: 65-758-4233
 Fax: 65-753-6181

Part Numbers:
 LQN6C472M04 (4.7mH, 35Ω)
 LQN6C103M04 (10mH, 80Ω)

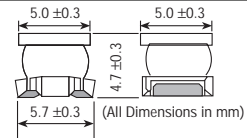

Coilcraft USA
 Ph: 847-639-6400
 Fax: 847-639-1469

Coilcraft Taiwan
 Ph: 886-2-264-3646
 Fax: 886-2-270-0294

Coilcraft Hong Kong
 Ph: 852-770-9428
 Fax: 852-770-0729

Coilcraft Europe
 Ph: 44-01236-730595
 Fax: 44-01236-730627

Coilcraft Singapore
 Ph: 65-296-6933
 Fax: 465-296-4463 #382

Part Numbers:
 DS1608C-106 (10mH, 32Ω)

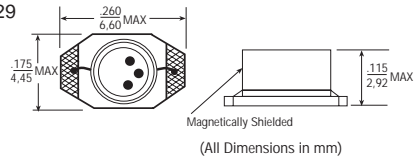

EL polarizers/transflector manufacturers

Nitto Denko
San Jose, CA
Phone: (510) 445-5400

Astra Products
Baldwin, NJ
Phone: (516) 223-7500
Fax: (516) 868-2371

EL Lamp manufacturers

Metro Mark/Leading Edge
Minnetonka, MN
Phone: (800) 680-5556
Phone: (612) 912-1700

Midori Mark Ltd.
1-5 Komagata 2-Chome
Taita-Ku 111-0043 Japan
Phone: 81-03-3848-2011

Luminescent Systems Inc. (LSI)
Lebanon, NH
Phone: (603) 643-7766
Fax: (603) 643-5947

NEC Corporation
Tokyo, Japan
Phone: (03) 3798-9572
Fax: (03) 3798-6134

Seiko Precision
Tokyo, Japan
Phone: (03) 5610-7089
Fax: .) 5610-7177

Gunze Electronics
2113 Wells Branch Parkway
Austin, TX 78728
Phone: (512) 752-1299
Fax: (512) 252-1181

All package dimensions in inches

8-pin NSOIC

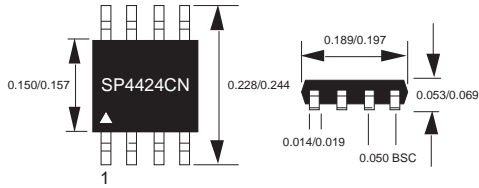

8-pin μ SOIC

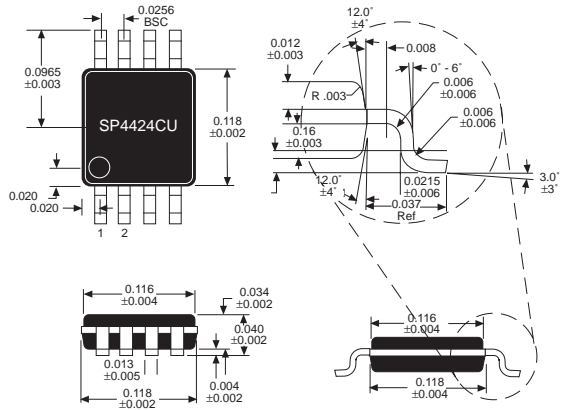

95 SP4424CN per tube, no minimum quantity



50 SP4424CU per tube

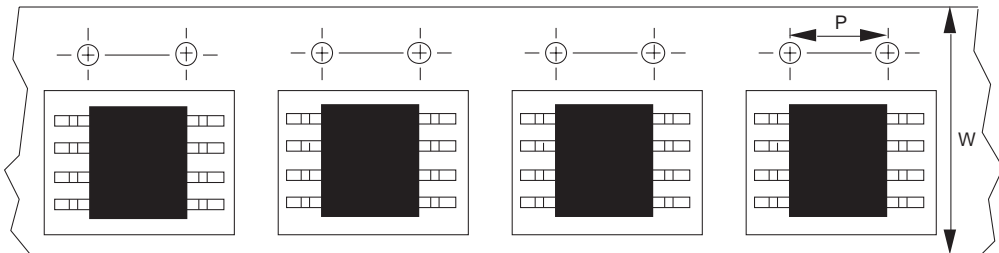

NSOIC-8 13" reels: P=8mm, W=12mm

μ SOIC-8 13" reels: P=8mm, W=12mm

Pkg.	Minimum qty per reel	Standard qty per reel	Maximum qty per reel
CN	500	2500	3000
CU	500	2500	3000

ORDERING INFORMATION

Model	Operating Temperature Range	Package Type
SP4424CN	-40°C to +85°C	8-Pin NSOIC
SP4424CU	-40°C to +85°C	8-Pin μ SOIC
SP4424CX	-40°C to +85°C	Die
SP4424NEB	N/A	NSOIC Evaluation Board
SP4424UEB	N/A	μ SOIC Evaluation Board

Please consult the factory for pricing and availability on a Tape-On-Reel option.



SIGNAL PROCESSING EXCELLENCE

Sipex Corporation

Headquarters and Sales Office

22 Linnell Circle
Billerica, MA 01821
TEL: (978) 667-8700
FAX: (978) 670-9001
e-mail: sales@sipex.com

Sales Office

233 South Hillview Drive
Milpitas, CA 95035
TEL: (408) 934-7500
FAX: (408) 935-7600

Sipex Corporation reserves the right to make changes to any products described herein. Sipex does not assume any liability arising out of the application or use of any product or circuit described hereing; neither does it convey any license under its patent rights nor the rights of others.