

Descriptions

- Switching application
- Interface circuit and driver circuit application

Features

- With built-in bias resistors
- Simplify circuit design
- Reduce a quantity of parts and manufacturing process
- High packing density

Ordering Information

Type NO.	Marking	Package Code
SRA2204M	2204	TO-92M

Outline Dimensions

unit : mm

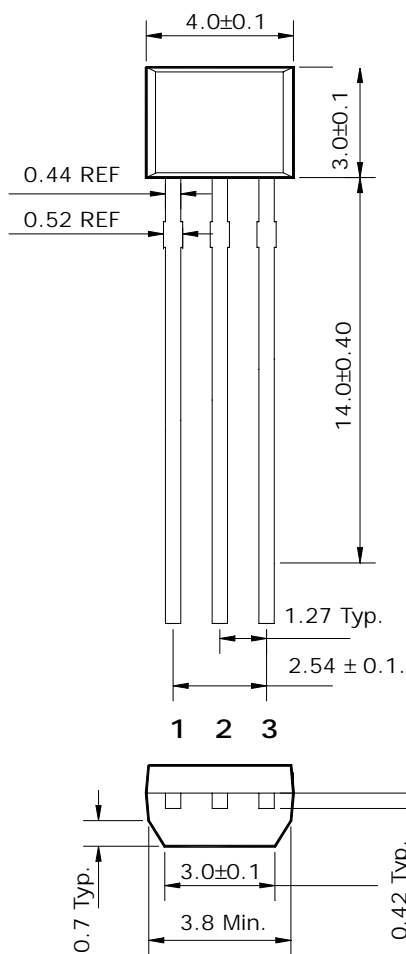

• Equivalent Circuit

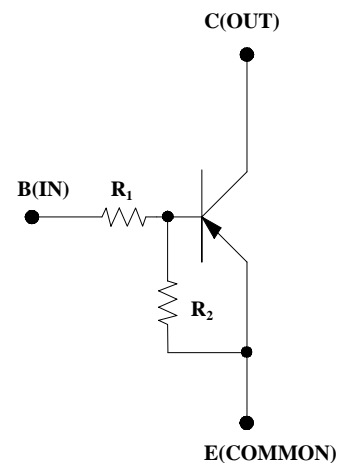

R ₁	R ₂
47KΩ	47KΩ

PIN Connections

1. Emitter
2. Collector
3. Base

Absolute maximum ratings

(Ta=25°C)

Characteristic	Symbol	Ratings	Unit
Out Voltage	V_o	-50	V
Input Voltage	V_i	-40	V
Out Current	I_o	-100	mA
Power Dissipation	P_D	400	mW
Junction Temperature	T_J	150	°C
Storage Temperature	T_{STG}	-55 ~ 150	°C

Electrical Characteristics

(Ta=25°C)

Characteristic	Symbol	Test Condition	Min.	Typ.	Max.	Unit
Output Cut-off Current	$I_{O(OFF)}$	$V_o = -50V, V_i = 0$	-	-	-500	nA
DC Current Gain	G_I	$V_o = -5V, I_o = -10mA$	80	200	-	-
Output Voltage	$V_{O(ON)}$	$I_o = -10mA, I_i = -0.5mA$	-	-0.1	-0.3	V
Input Voltage (ON)	$V_{I(ON)}$	$V_o = -0.2V, I_o = -5mA$	-	-2.8	-5.0	V
Input Voltage (OFF)	$V_{I(OFF)}$	$V_o = -5V, I_o = -0.1mA$	-1.0	-1.2	-	V
Transition Frequency	f_T^*	$V_o = -10V, I_o = -5mA$	-	200	-	MHz
Input Current	I_i	$V_i = -5V$	-	-	-0.18	mA

* : Characteristic of Transistor Only

Electrical Characteristic Curves

Fig. 1 $I_o - V_{I(ON)}$

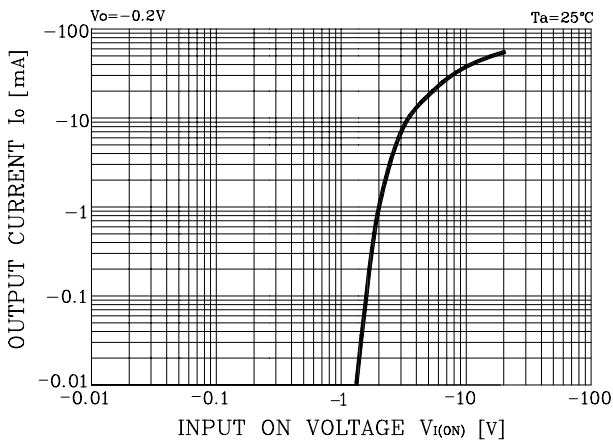

Fig. 2 $I_o - V_{I(OFF)}$

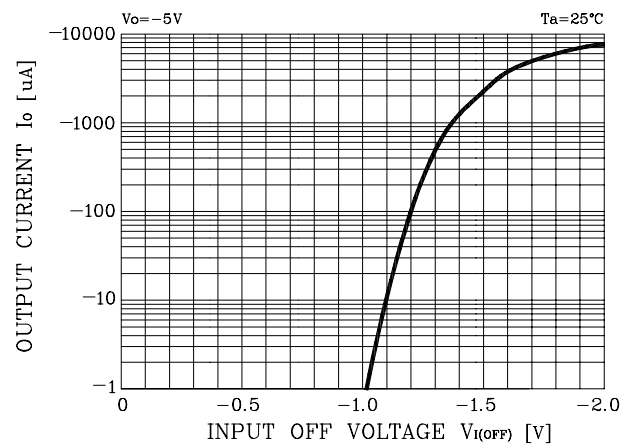

Fig. 3 $G_1 - I_o$

