

SRM20100LC_{70/85/10}

CMOS 1M-BIT STATIC RAM

- Low Supply Current
- Access Time 70ns/85ns/100ns
- 131,072 Words × 8-Bit Asynchronous

DESCRIPTION

The SRM20100LC_{70/85/10} is an 131,072 words × 8-bit asynchronous, static, random access memory on a monolithic CMOS chip. Its very low standby power requirement makes it ideal for applications requiring non-volatile storage with back-up batteries. The asynchronous and static nature of the memory requires no external clock or refreshing circuit. Both the input and output ports are TTL compatible and the 3-state output allows easy expansion of memory capacity.

FEATURES

- Fast Access time..... SRM20100LC₇₀ 70ns (Max)*
SRM20100LC₈₅ 85ns (Max)
SRM20100LC₁₀ 100ns (Max)
- Low supply current..... standby : 2μA (Typ)
operation: 15mA/MHz (Typ)
- Completely static..... No clock required
- Single power supply..... 5V ± 10%
- TTL compatible inputs and outputs
- 3-state output with wired-OR capability
- Non-volatile storage with back-up batteries
- Package..... SRM20100LC_{70/85/10} DIP-32pin (plastic)
SRM20100LM_{70/85/10} SOP6-32pin (plastic)
SRM20100LTM_{70/85/10} TSOP-32pin (plastic)*
SRM20100LRM_{70/85/10} TSOPR-32pin (plastic)*

* : Under development

BLOCK DIAGRAM

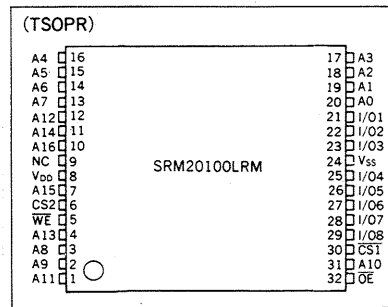
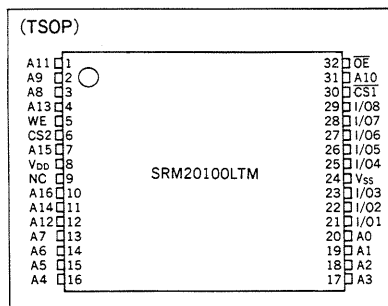
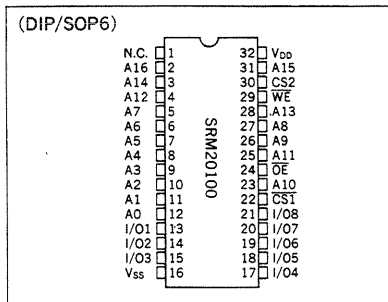
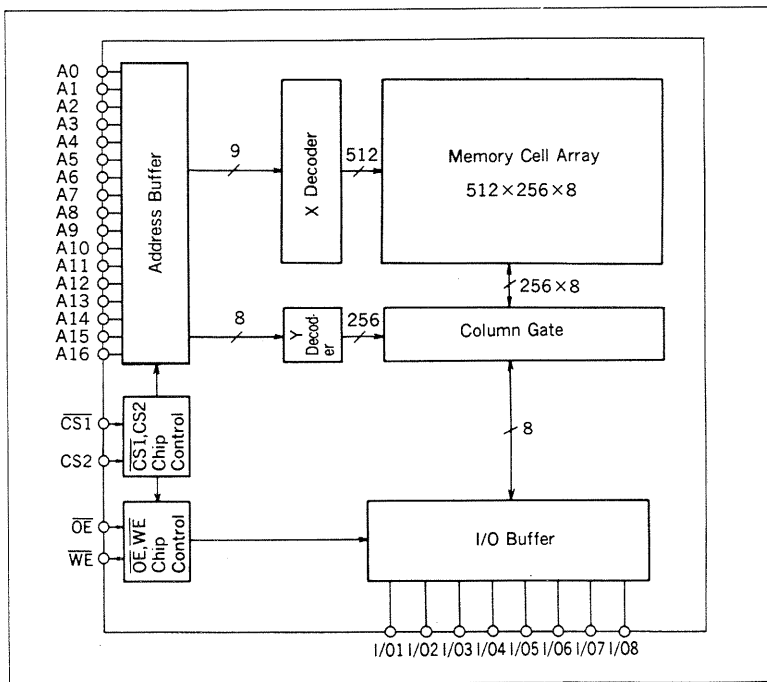

PIN DESCRIPTION

A0 to A16	Address Input
WE	Write Enable
OE	Output Enable
CS1, CS2	Chip Select
I/O1 to 8	Data I/O
VDD	Power Supply(+5V)
VSS	Power Supply(0V)
NC	No connection

■ ABSOLUTE MAXIMUM RATINGS

(V_{SS}=0V)

Parameter	Symbol	Ratings	Unit
Supply voltage	V _{DD}	-0.5 to 7.0	V
Input voltage*	V _I	-0.5 to 7.0	V
Input/Output voltage*	V _{I/O}	-0.5 to V _{DD} + 0.3	V
Power dissipation	P _D	1.0	W
Operating temperature	T _{opr}	0 to 70	°C
Storage temperature	T _{stg}	-65 to 150	°C
Soldering temperature and time	T _{sol}	260°C, 10s (at lead)	—

* V_I, V_{I/O} (Min) = -3.0V (Pulse width is 50ns)

■ DC RECOMMENDED OPERATING CONDITIONS

(V_{SS}=0V, Ta=0 to 70°C)

Parameter	Symbol	Conditions	Min	Typ	Max	Unit
Supply voltage	V _{DD}	—	4.5	5.0	5.5	V
	V _{SS}	—	0	0	0	V
Input voltage	V _{IH}	—	2.2	3.5	V _{DD} + 0.3	V
	V _{IL}	—	-0.3*	0	0.8	V

* If pulse width is less than 50ns, it is -3.0V

■ ELECTRICAL CHARACTERISTICS

● DC Electrical Characteristics

(V_{DD} = 5V ± 10%, V_{SS} = 0V, Ta = 0 to 70°C)

Parameter	Symbol	Conditions	SRM20100LC70			SRM20100LC85			SRM20100LC10			Unit
			Min	Typ*	Max	Min	Typ*	Max	Min	Typ*	Max	
Input leakage	I _{LI}	V _I = 0 to V _{DD}	-1	—	1	-1	—	1	-1	—	1	μA
Standby supply current	I _{DD5}	CS1 = V _{IH} or CS2 = V _{IL}	-	1.0	3.0	-	1.0	3.0	-	1.0	3.0	mA
	I _{DD51}	CS1 = CS2 ≥ V _{DD} - 0.2V or CS2 ≤ 0.2V	-	2	100	-	2	100	-	2	100	μA
Average operating current	I _{DDA}	V _I = V _{IL} , V _{IH} I _{I/O} = 0mA t _{cyc} = Min	-	45	70	-	45	70	-	45	70	mA
Operating supply current	I _{DD0}	V _I = V _{IL} , V _{IH} I _{I/O} = 0mA	-	15	35	-	15	35	-	15	35	mA
Output leakage	I _{LO}	CS1 = V _{IH} or CS2 = V _{IL} or WE = V _{IL} or OE = V _{IH} V _{I/O} = 0 to V _{DD}	-1	—	1	-1	—	1	-1	—	1	μA
High level output voltage	V _{OH}	I _{OH} = -1.0mA	2.4	—	—	2.4	—	—	2.4	—	—	V
Low level output voltage	V _{OL}	I _{OL} = 2.1mA	—	—	0.4	—	—	0.4	—	—	0.4	V

* Typical values are measured at Ta = 25°C and V_{DD} = 5.0V

● Terminal Capacitance

(f = 1MHz, Ta = 25°C)

Parameter	Symbol	Conditions	Min	Typ	Max	Unit
Address Capacitance	C _{ADD}	V _{ADD} = 0V	—	—	8	pF
Input Capacitance	C _I	V _I = 0V	—	—	10	pF
I/O Capacitance	C _{I/O}	V _{I/O} = 0V	—	—	10	pF

● AC Electrical Characteristics

○ Read Cycle

(V_{DD} = 5V ± 10%, V_{SS} = 0V, Ta = 0 to 70°C)

Parameter	Symbol	Conditions	SRM20100LC70		SRM20100LC85		SRM20100LC10		Unit
			Min	Max	Min	Max	Min	Max	
Read cycle time	t _{RC}	* 1	70	—	85	—	100	—	ns
Address access time	t _{ACC}		—	70	—	85	—	100	ns
Chip select 1 access time	t _{ACS1}		—	70	—	85	—	100	ns
Chip select 2 access time	t _{ACS2}		—	70	—	85	—	100	ns
Output enable access time	t _{OE}		—	40	—	45	—	50	ns
Chip select 1 output set time	t _{CLZ1}	* 2	10	—	10	—	10	—	ns
Chip select 1 output floating	t _{CHZ1}		—	30	—	30	—	35	ns
Chip select 2 output set time	t _{CLZ2}		10	—	10	—	10	—	ns
Chip select 2 output floating	t _{CHZ2}		—	30	—	30	—	35	ns
Output enable output set time	t _{OLZ}		5	—	5	—	5	—	ns
Output enable output floating	t _{OHZ}		—	30	—	30	—	35	ns
Output hold time	t _{OH}	* 1	10	—	10	—	10	—	ns

○ Write Cycle

($V_{DD} = 5V \pm 10\%$, $V_{SS} = 0V$, $T_a = 0$ to $70^\circ C$)

Parameter	Symbol	Conditions	SRM20100LC ₇₀		SRM20100LC ₈₅		SRM20100LC ₁₀		Unit
			Min	Max	Min	Max	Min	Max	
Write cycle time	t_{WC}	* 1	70	—	85	—	100	—	ns
Chip select time 1	t_{CW1}		60	—	70	—	80	—	ns
Chip select time 2	t_{CW2}		60	—	70	—	80	—	ns
Address enable time	t_{AW}		60	—	70	—	80	—	ns
Address setup time	t_{AS}		0	—	0	—	0	—	ns
Write pulse width	t_{WP}		55	—	65	—	75	—	ns
Address hold time	t_{WR}		0	—	0	—	0	—	ns
Input data setup time	t_{DW}		30	—	35	—	40	—	ns
Input data hold time	t_{DH}		0	—	0	—	0	—	ns
\overline{WE} Output floating	t_{WHZ}	* 2	—	30	—	30	—	35	ns
\overline{WE} Output setup time	t_{OW}		5	—	5	—	5	—	ns

* 1 Test Conditions

1. Input pulse level : 0.6V to 2.4V
2. $t_r = t_f = 5ns$
3. Input and output timing reference levels : 1.5V
4. Output load $C_L = 100pF$

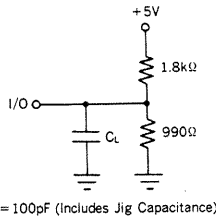

* 2 Test Conditions

1. Input pulse level : 0.6V to 2.4V
2. $t_r = t_f = 5ns$
3. Input timing reference levels : 1.5V
4. Output timing reference levels : $\pm 200mV$ (the level displaced from stable output voltage level)
5. Output load $C_L = 5pF$

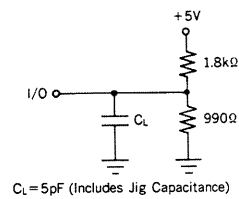

● Timing Chart

○ Read Cycle

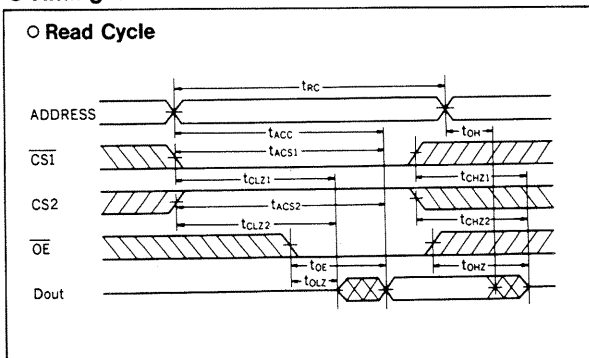

○ Write Cycle (1) (CS1 Control)

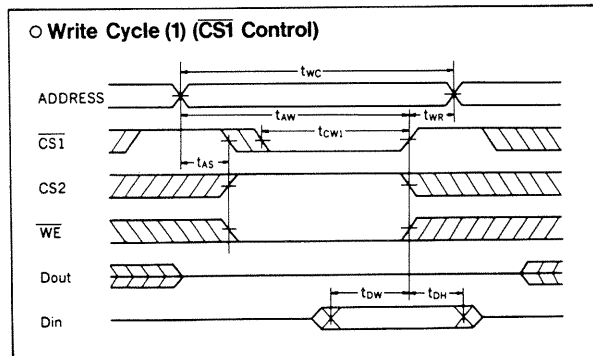

○ Write Cycle (2) (CS2 Control)

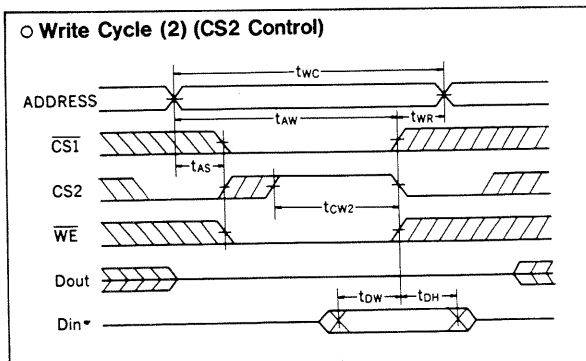

○ Write Cycle (3) (WE Control)

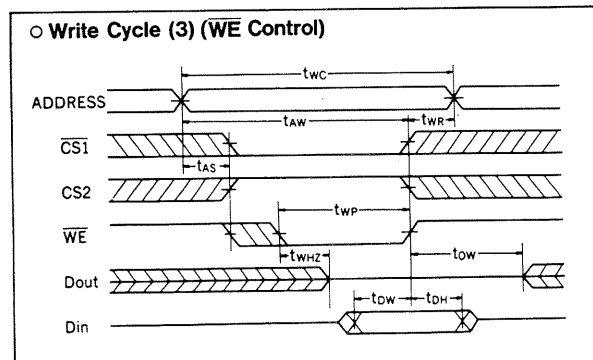

- Note :
1. During read cycle time, \overline{WE} is to be "H" level.
 2. During write cycle time that is controlled by CS1 or CS2, Output Buffer is in high impedance state whether \overline{OE} level is "H" or "L".
 3. During write cycle time that is controlled by \overline{WE} , Output Buffer is high impedance state if \overline{OE} is "H" level.
 4. When I/O terminals are output mode, be careful that do not give the opposite signals to the I/O terminals.

DATA RETENTION CHARACTERISTIC WITH LOW VOLTAGE POWER SUPPLY

(Ta = 0 to 70°C)

Parameter	Symbol	Conditions	Min	Typ	Max	Unit
Data retention supply voltage	V_{DDR}		2.0	—	5.5	V
Data retention current	I_{DDR}	$V_{DD} = 3V$ $CS1 = CS2 \geq V_{DD} - 0.2V$ or $CS2 \leq 0.2V$	—	1 *1	50	μA
Chip select data hold time	t_{CDR}		0	—	—	ns
Operation recovery time	t_R		t_{RC} *2	—	—	ns

*1 Ta = 25°C

*2 t_{RC} = Read cycle time

Data retention timing (CS1 Control)

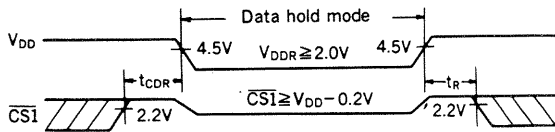

Data retention timing (CS2 Control)

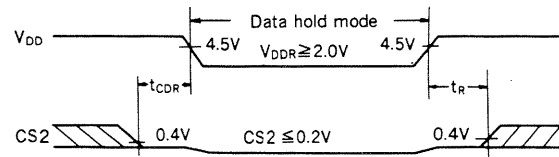

FUNCTIONS

Truth Table

$\overline{CS1}$	CS2	\overline{OE}	\overline{WE}	DATA I/O	Mode	I_{DD}
H	X	—	—	Hi-Z	Unselected	I_{DDs}, I_{DDs1}
—	L	—	—	Hi-Z	Unselected	I_{DDs}, I_{DDs1}
L	H	X	L	Input data	Write	I_{DD0}
L	H	L	H	Output data	Read	I_{DD0}
L	H	H	H	Hi-Z	Output disable	I_{DD0}

X: "H" or "L", — : "H", "L" or "Hi-Z"

Reading data

Data is able to be read when the address is setted while holding $\overline{CS1} = "L"$, $CS2 = "H"$, $\overline{OE} = "L"$ and $\overline{WE} = "H"$. Since Data I/O terminals are in high impedance state when $\overline{OE} = "H"$, the data bus line can be used for any other objective, then access time apparently is able to be cut down.

Writing data

There are the following four ways of writing data into the memory.

- (1) Hold $CS2 = "H"$, $\overline{WE} = "L"$ set addresses and give "L" pulse to $\overline{CS1}$.
- (2) Hold $\overline{CS1} = "L"$, $\overline{WE} = "L"$, set addresses and give "H" pulse to CS2.
- (3) Hold $\overline{CS1} = "L"$, $CS2 = "H"$, set addresses and give "L" pulse to \overline{WE} .
- (4) After setting addresses, give "L" pulse to $\overline{CS1}$, \overline{WE} and give "H" pulse to CS2.

Anyway, data on the Data I/O terminals are latched up into the SRM20100LC70/85/10 at the end of the period that $\overline{CS1}$, \overline{WE} are "L" level, and CS2 is "H" level. As Data I/O terminals are in high impedance state when any of $\overline{CS1}$, $\overline{OE} = "H"$, or $CS2 = "L"$, the contention on the data bus can be avoided.

● Standby mode

When $\overline{CS1}$ is "H" or CS2 is "L" level, the SRM20100LC_{70/85/10} is in the standby mode which has retaining date operation. In this case Data I/O terminals are Hi-Z, and all inputs of addresses, \overline{WE} and data can be any "H" or "L". When $\overline{CS1}$ and CS2 level are in the range over $V_{DD}-0.2V$, or CS2 level is in the range under 0.2V, in the SRM20100LC_{70/85/10} there is almost no current flow except through the high resistance parts of the memory.

■ PACKAGE DIMENSIONS

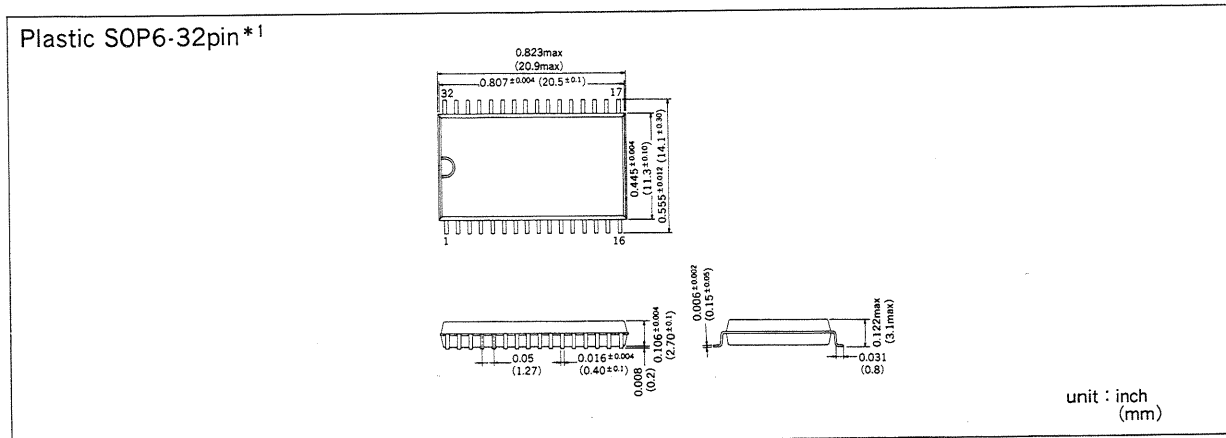
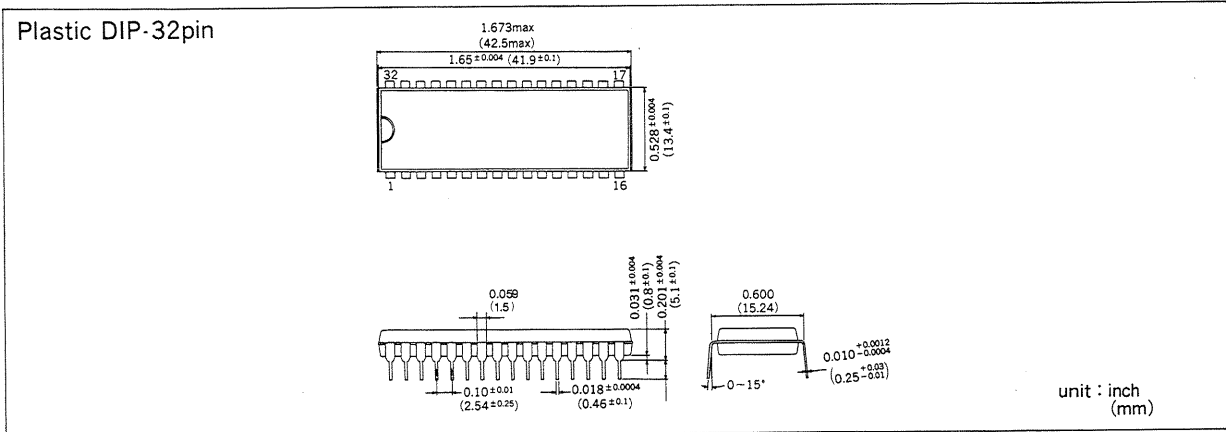

* 1 SRM20100LM_{70/85/10} has the same characteristics as SRM20100LC_{70/85/10}.

Plastic TSOP-32pin*1
(Under development)

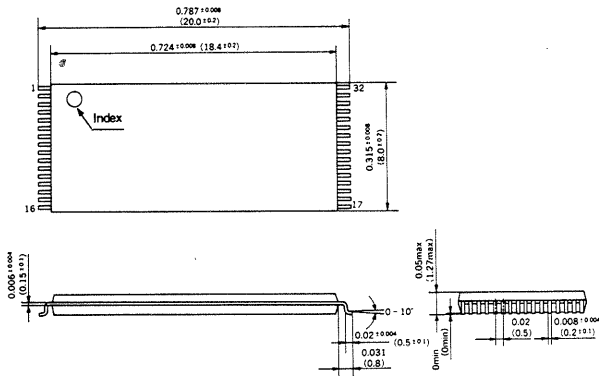

unit : inch
(mm)

*1 SRM20100LTM70/85/100 has the same characteristics as SRM20100LC70/85/10.

Plastic TSOPR-32pin*2
(Under development)

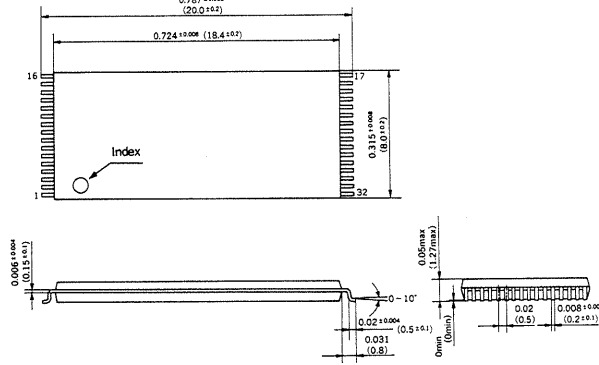

unit : inch
(mm)

*2 SRM20100LRM70/85/100 has the same characteristics as SRM20100LC70/85/10.

■ CHARACTERISTICS CURVES

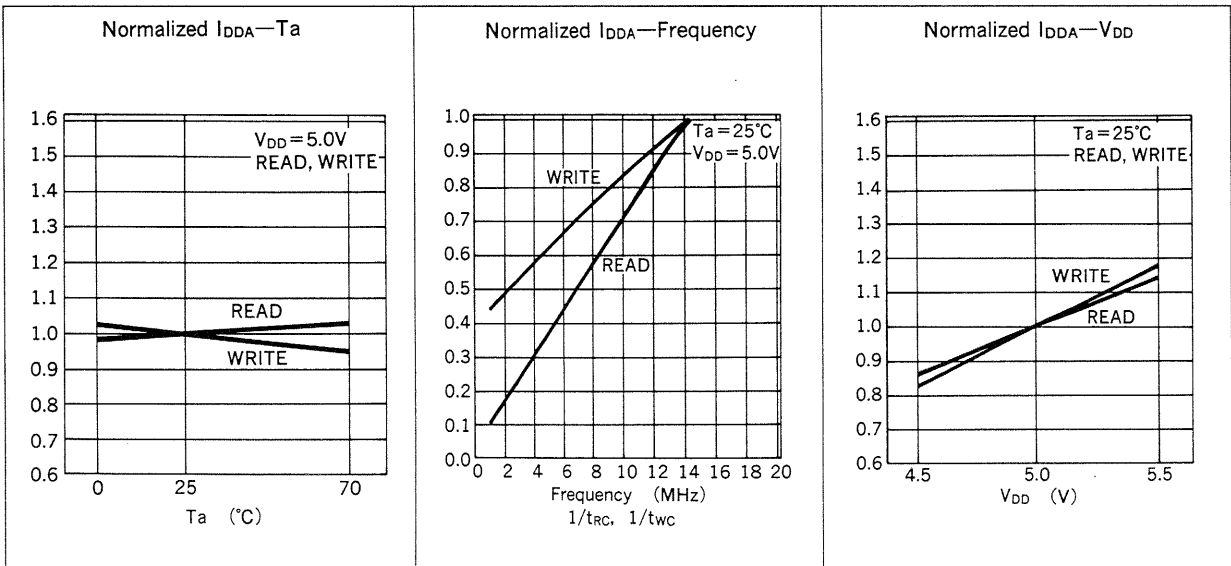

Normalized I_{DD1} — T_a

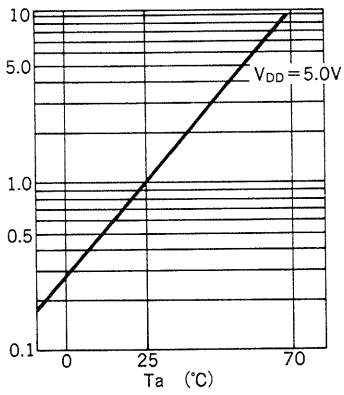

Normalized I_{DD1} — V_{DD}

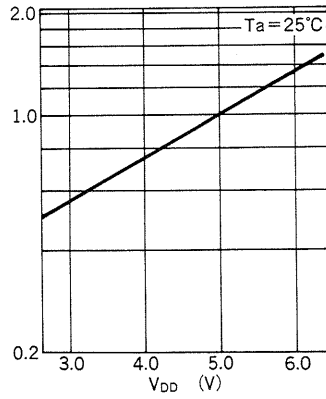

Normalized I_{OH} — V_{OH}

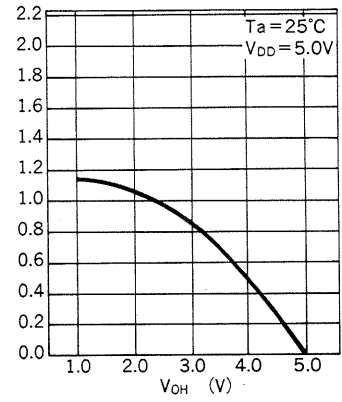

Normalized $\frac{t_{ACC}}{t_{ACS1}}$
 $\frac{t_{ACS2}}{t_{ACS1}}$ — T_a

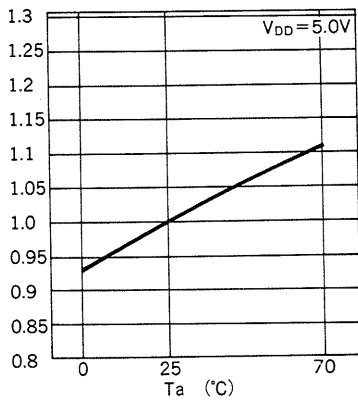

Normalized $\frac{t_{ACC}}{t_{ACS1}}$
 $\frac{t_{ACS2}}{t_{ACS1}}$ — V_{DD}

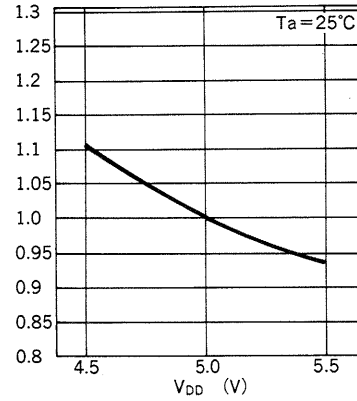

Normalized I_{OL} — V_{OL}

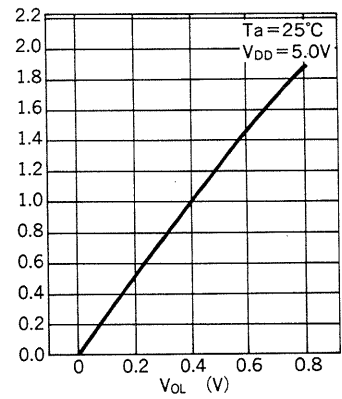

Normalized $\frac{t_{ACC}}{t_{ACS1}}$
 $\frac{t_{ACS2}}{t_{ACS1}}$ — C_L

