

FEATURES

- ❑ Lower $R_{DS(on)}$
- ❑ Improved Inductive Ruggedness
- ❑ Fast Switching Times
- ❑ Low Input Capacitance
- ❑ Extended Safe Operating Area
- ❑ Improved High Temperature Reliability

Product Summary

Part Number	BV_{DSS}	$R_{DS(on)}$	I_D
SSD2009	50V	0.13 Ω	3.0A

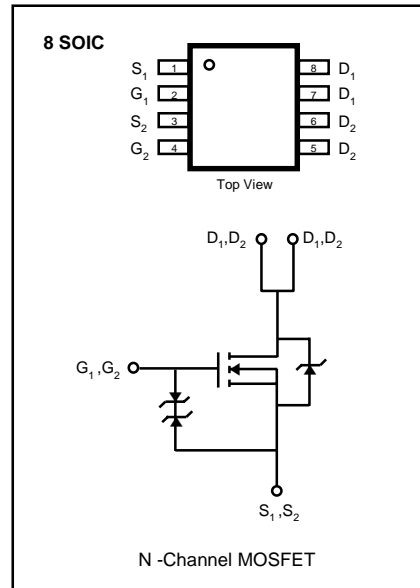

Absolute Maximum Ratings

Symbol	Characteristic	Value	Units
V_{DSS}	Drain-to-Source Voltage	50	V
I_D	Continuous Drain Current $T_A=25^\circ\text{C}$	3.0	A
	Continuous Drain Current $T_A=70^\circ\text{C}$	2.3	
I_{DM}	Drain Current-Pulsed ^①	10.0	A
V_{GS}	Gate-to-Source Voltage	± 20	V
P_D	Total Power Dissipation ($T_A=25^\circ\text{C}$)	2.0	W
	($T_A=70^\circ\text{C}$)	1.3	
T_J, T_{STG}	Operating and Junction Storage Temperature Range	- 55 to +150	$^\circ\text{C}$

Thermal Resistance

Symbol	Characteristic	Typ.	Max.	Units
$R_{\theta JA}$	Junction-to-Ambient	--	62.5	$^\circ\text{C}/\text{W}$

Electrical Characteristics (T_C=25°C unless otherwise specified)

Symbol	Characteristic	Min.	Typ.	Max.	Units	Test Condition
B _V DSS	Drain-Source Breakdown Voltage	50	--	--	V	V _{GS} =0V, I _D =250μA
V _{GS(th)}	Gate Threshold Voltage	1.0	--	3.0	V	V _{DS} =5V, I _D =250μA
I _{GSS}	Gate-Source Leakage, Forward	--	--	100	nA	V _{GS} =20V
	Gate-Source Leakage, Reverse	--	--	-100	nA	V _{GS} =-20V
I _{DSS}	Drain-to-Source Leakage Current	--	--	2.0	μA	V _{DS} =40V
		--	--	25		V _{DS} =40V, T _C =55°C
I _{DON}	On-State Drain-Source Current	10	--	--	A	V _{DS} =5V, V _{GS} =10V
R _{DS(on)}	Static Drain-Source	--	0.065	0.13	Ω	V _{GS} =10V, I _D =3.0A
	On-State Resistance ②	--	0.084	0.2		V _{GS} =4.5V, I _D =1.5A
g _{fs}	Forward Transconductance ②	--	7.0	--	S	V _{DS} =15V, I _D =3.0A
t _{d(on)}	Turn-On Delay Time	--	16	20	ns	V _{DD} =25V, I _D =1.0A, R _θ =6.0Ω, ②③
t _r	Rise Time	--	16	20		
t _{d(off)}	Turn-Off Delay Time	--	40	70		
t _f	Fall Time	--	23	50		
Q _g	Total Gate Charge	--	17	25	nC	V _{DS} =25V, V _{GS} =10V, I _D =2.0A ②③
Q _{gs}	Gate-Source Charge	--	1.8	--		
Q _{gd}	Gate-Drain ("Miller") Charge	--	3.9	--		

Source-Drain Diode Ratings and Characteristics

Symbol	Characteristic	Min.	Typ.	Max.	Units	Test Condition
I _S	Continuous Source Current (Body Diode)	--	--	2.0	A	Modified MOSFET Symbol Showing the Integral Reverse P-N Junction Rectifier 
V _{SD}	Diode Forward Voltage ②	--	--	1.2	V	T _A =25°C, I _S =1.5A, V _{GS} =0V
t _{rr}	Reverse Recovery Time ②	--	100	--	ns	T _A =25°C, I _F =1.5A, di _F /dt=100A/μs

Notes ;

- ① Repetitive Rating : Pulse Width Limited by Maximum Junction Temperature
- ② Pulse Test : Pulse Width = 250μs, Duty Cycle ≤ 2%
- ③ Essentially Independent of Operating Temperature

Fig 1. Output Characteristics

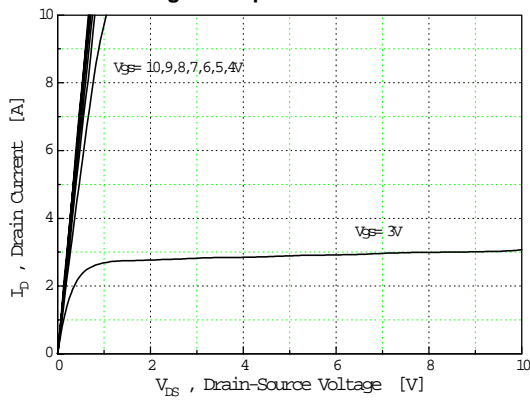

Fig 2. Transfer Characteristics

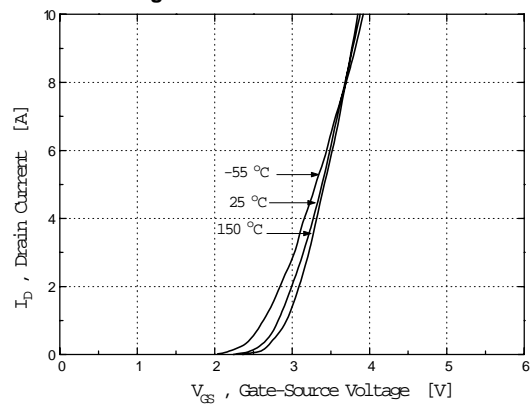

Fig 3. On-Resistance vs. Drain Current

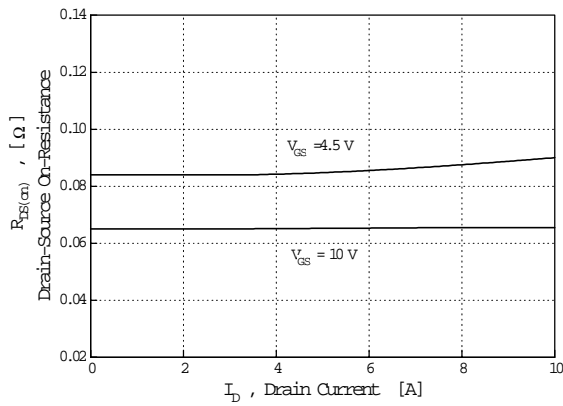

Fig 4. Source-Drain Forward Voltage

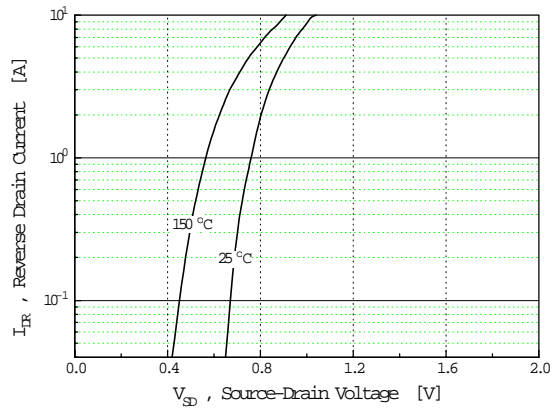

Fig 5. Capacitance vs. Drain-Source Voltage

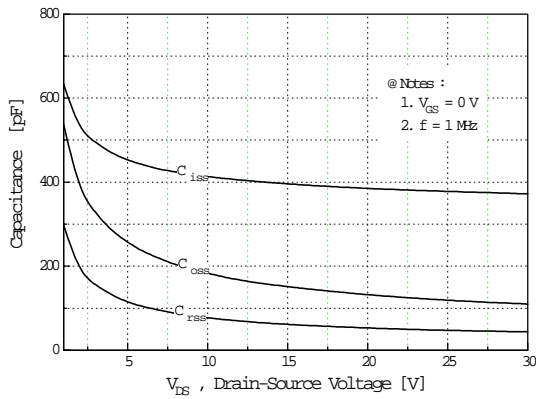

Fig 6. Gate Charge vs. Gate-Source Voltage

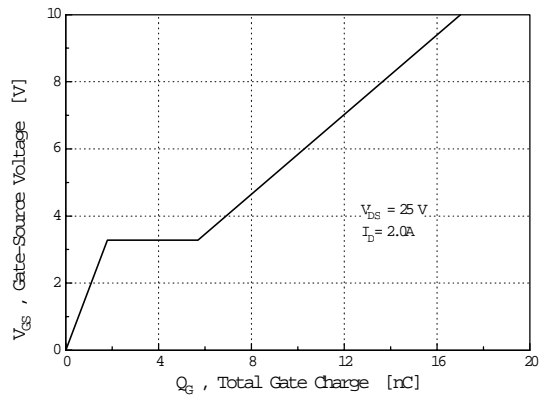

Fig 7. Breakdown Voltage vs. Temperature

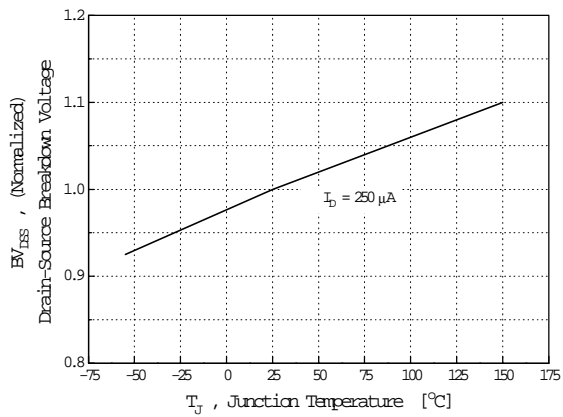

Fig 8. On-Resistance vs. Temperature

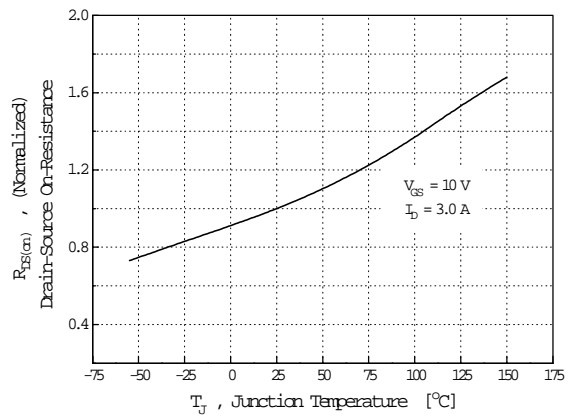
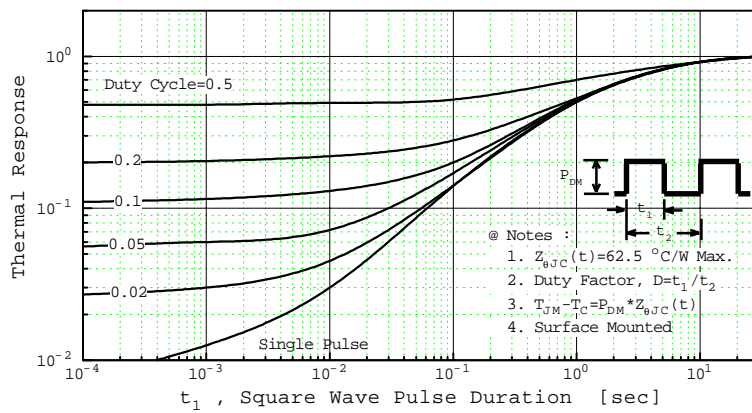

Fig 9. Normalized Effective Transient Thermal Impedance, Junction-to-Ambient



TRADEMARKS

The following are registered and unregistered trademarks Fairchild Semiconductor owns or is authorized to use and is not intended to be an exhaustive list of all such trademarks.

ACE _x [™]	FAST [®]	MICROWIRE [™]	SILENT SWITCHER [®]	UHC [™]
Bottomless [™]	FAST _r [™]	OPTOLOGIC [®]	SMART START [™]	UltraFET [®]
CoolFET [™]	FRFET [™]	OPTOPLANAR [™]	SPM [™]	VCX [™]
CROSSVOLT [™]	GlobalOptoisolator [™]	PACMAN [™]	STAR*POWER [™]	
DenseTrench [™]	GTO [™]	POP [™]	Stealth [™]	
DOME [™]	HiSeC [™]	Power247 [™]	SuperSOT [™] -3	
EcoSPARK [™]	I ² C [™]	PowerTrench [®]	SuperSOT [™] -6	
E ² CMOS [™]	ISOPLANAR [™]	QFET [™]	SuperSOT [™] -8	
EnSigna [™]	LittleFET [™]	QS [™]	SyncFET [™]	
FACT [™]	MicroFET [™]	QT Optoelectronics [™]	TinyLogic [™]	
FACT Quiet Series [™]	MicroPak [™]	Quiet Series [™]	TruTranslation [™]	

STAR*POWER is used under license

DISCLAIMER

FAIRCHILD SEMICONDUCTOR RESERVES THE RIGHT TO MAKE CHANGES WITHOUT FURTHER NOTICE TO ANY PRODUCTS HEREIN TO IMPROVE RELIABILITY, FUNCTION OR DESIGN. FAIRCHILD DOES NOT ASSUME ANY LIABILITY ARISING OUT OF THE APPLICATION OR USE OF ANY PRODUCT OR CIRCUIT DESCRIBED HEREIN; NEITHER DOES IT CONVEY ANY LICENSE UNDER ITS PATENT RIGHTS, NOR THE RIGHTS OF OTHERS.

LIFE SUPPORT POLICY

FAIRCHILD'S PRODUCTS ARE NOT AUTHORIZED FOR USE AS CRITICAL COMPONENTS IN LIFE SUPPORT DEVICES OR SYSTEMS WITHOUT THE EXPRESS WRITTEN APPROVAL OF FAIRCHILD SEMICONDUCTOR CORPORATION. As used herein:

1. Life support devices or systems are devices or systems which, (a) are intended for surgical implant into the body, or (b) support or sustain life, or (c) whose failure to perform when properly used in accordance with instructions for use provided in the labeling, can be reasonably expected to result in significant injury to the user.
2. A critical component is any component of a life support device or system whose failure to perform can be reasonably expected to cause the failure of the life support device or system, or to affect its safety or effectiveness.

PRODUCT STATUS DEFINITIONS

Definition of Terms

Datasheet Identification	Product Status	Definition
Advance Information	Formative or In Design	This datasheet contains the design specifications for product development. Specifications may change in any manner without notice.
Preliminary	First Production	This datasheet contains preliminary data, and supplementary data will be published at a later date. Fairchild Semiconductor reserves the right to make changes at any time without notice in order to improve design.
No Identification Needed	Full Production	This datasheet contains final specifications. Fairchild Semiconductor reserves the right to make changes at any time without notice in order to improve design.
Obsolete	Not In Production	This datasheet contains specifications on a product that has been discontinued by Fairchild semiconductor. The datasheet is printed for reference information only.