



# STGP10NB60SDFP

N-CHANNEL 10A - 600V - TO-220FP

PowerMesh™ IGBT

TYPE	V <sub>CES</sub>	V <sub>CE(sat)</sub>	I <sub>C</sub>
STGP10NB60SDFP	600	< 1.8 V	10 A

- HIGHT INPUT IMPEDANCE (VOLTAGE DRIVEN)
- LOW ON-VOLTAGE DROP
- HIGH CURRENT CAPABILITY
- OFF LOSSES INCLUDE TAIL CURRENT

## DESCRIPTION

Using the latest high voltage technology based on a patented strip layout, STMicroelectronics has designed an advanced family of IGBTs, the PowerMESH™ IGBTs, with outstanding performances. The suffix "S" identifies a family optimized achieve minimum on-voltage drop for low frequency applications (<1kHz).

## APPLICATIONS

- LIGHT DIMMER
- STATIC RELAYS
- MOTOR CONTROL

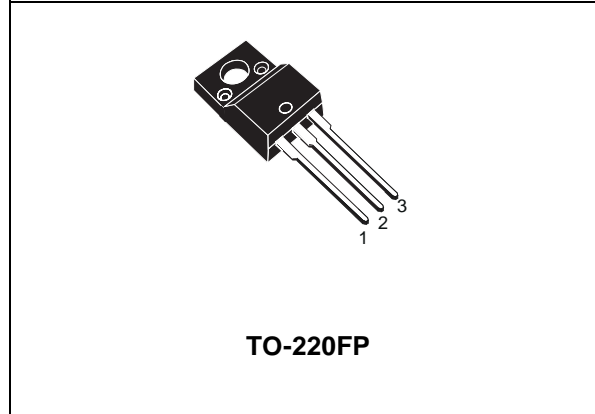

TO-220FP

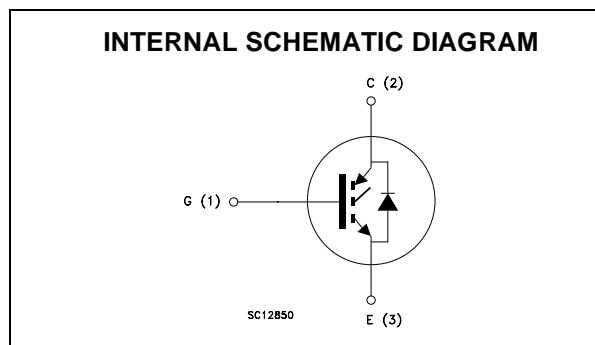

## ABSOLUTE MAXIMUM RATINGS

Symbol	Parameter	Value	Unit
V <sub>CES</sub>	Collector-Emitter Voltage (V <sub>GS</sub> = 0)	600	V
V <sub>ECR</sub>	Reverse Battery Protection	20	V
V <sub>GE</sub>	Gate-Emitter Voltage	± 20	V
I <sub>C</sub>	Collector Current (continuous) at T <sub>C</sub> = 25°C	20	A
I <sub>C</sub>	Collector Current (continuous) at T <sub>C</sub> = 100°C	10	A
I <sub>CM</sub> (■)	Collector Current (pulsed)	80	A
P <sub>TOT</sub>	Total Dissipation at T <sub>C</sub> = 25°C	30	W
	Derating Factor	0.2	W/°C
V <sub>ISO</sub>	Insulation Withstand Voltage A.C. (t = 1 sec; T <sub>C</sub> = 25°C)	2500	V
T <sub>stg</sub>	Storage Temperature	-65 to 150	°C
T <sub>j</sub>	Max. Operating Junction Temperature	175	°C

(●) Pulse width limited by safe operating area

## STGP10NB60SDFP

### THERMAL DATA

Rthj-case	Thermal Resistance Junction-case Max	5	°C/W
Rthj-amb	Thermal Resistance Junction-ambient Max	62.5	°C/W
Rthc-sink	Thermal Resistance Case-sink Typ	0.5	°C/W

### ELECTRICAL CHARACTERISTICS (T<sub>CASE</sub> = 25 °C UNLESS OTHERWISE SPECIFIED)

OFF

Symbol	Parameter	Test Conditions	Min.	Typ.	Max.	Unit
V <sub>BR(CES)</sub>	Collector-Emitter Break-down Voltage	I <sub>C</sub> = 250 μA, V <sub>GE</sub> = 0,	600			V
V <sub>BR(CES)</sub>	Emitter Collector Break-down Voltage	I <sub>C</sub> = 1 mA, V <sub>GE</sub> = 0,	20			V
I <sub>CES</sub>	Collector cut-off Current (V <sub>GE</sub> = 0)	V <sub>CE</sub> = Max Rating, T <sub>J</sub> = 25 °C V <sub>CE</sub> = Max Rating, T <sub>J</sub> = 125 °C			10 100	μA μA
I <sub>GES</sub>	Gate-Emitter Leakage Current (V <sub>CE</sub> = 0)	V <sub>GE</sub> = ± 20V, V <sub>CE</sub> = 0			± 100	nA

ON (1)

Symbol	Parameter	Test Conditions	Min.	Typ.	Max.	Unit
V <sub>GE(th)</sub>	Gate Threshold Voltage	V <sub>CE</sub> = V <sub>GE</sub> , I <sub>C</sub> = 250μA	2.5		5	V
V <sub>CE(SAT)</sub>	Collector-Emitter Saturation Voltage	V <sub>GE</sub> = 15V, I <sub>C</sub> = 5 A, T <sub>J</sub> = 25°C V <sub>GE</sub> = 15V, I <sub>C</sub> = 10 A, T <sub>J</sub> = 25°C V <sub>GE</sub> = 15V, I <sub>C</sub> = 10 A, T <sub>J</sub> = 125°C		1.15 1.35 1.25	1.8	V V V

### DYNAMIC

Symbol	Parameter	Test Conditions	Min.	Typ.	Max.	Unit
g <sub>fs</sub>	Forward Transconductance	V <sub>CE</sub> = 25 V, I <sub>C</sub> = 10 A	5			S
C <sub>ies</sub> C <sub>oes</sub> C <sub>res</sub>	Input Capacitance Output Capacitance Reverse Transfer Capacitance	V <sub>CE</sub> = 25V, f = 1 MHz, V <sub>GE</sub> = 0		610 65 12		pF pF pF
Q <sub>g</sub>	Gate Charge	V <sub>CE</sub> = 400V, I <sub>C</sub> = 10 A, V <sub>GE</sub> = 15V		33		nC
I <sub>CL</sub>	Latching Current	V <sub>clamp</sub> = 480V, R <sub>G</sub> = 1kΩ, T <sub>J</sub> = 125°C	20			A

SWITCHING ON

Symbol	Parameter	Test Conditions	Min.	Typ.	Max.	Unit
$t_{d(on)}$	Turn-on Delay Time	$V_{CC} = 480\text{ V}, I_C = 10\text{ A}$ $R_G = 1\text{ K}\Omega, V_{GE} = 15\text{ V}$		0.7		$\mu\text{s}$
$t_r$	Rise Time			0.46		$\mu\text{s}$
$(di/dt)_{on}$	Turn-on Current Slope	$V_{CC} = 480\text{ V}, I_C = 10\text{ A}$ $R_G = 1\text{ K}\Omega, V_{GE} = 15\text{ V}$		8		$\text{A}/\mu\text{s}$
$E_{on}$	Turn-on Switching Losses			0.6		mJ

SWITCHING OFF

Symbol	Parameter	Test Conditions	Min.	Typ.	Max.	Unit
$t_c$	Cross-over Time	$V_{clamp} = 480\text{ V}, I_C = 10\text{ A},$ $R_{GE} = 1\text{ K}\Omega, V_{GE} = 15\text{ V}$		2.2		$\mu\text{s}$
$t_r(V_{off})$	Off Voltage Rise Time			1.2		$\mu\text{s}$
$t_f$	Fall Time			1.2		$\mu\text{s}$
$E_{off(**)}$	Turn-off Switching Loss			5.0		mJ
$t_c$	Cross-over Time	$V_{clamp} = 480\text{ V}, I_C = 10\text{ A},$ $R_{GE} = 1\text{ K}\Omega, V_{GE} = 15\text{ V}$ $T_j = 125\text{ }^\circ\text{C}$		3.8		$\mu\text{s}$
$t_r(V_{off})$	Off Voltage Rise Time			1.2		$\mu\text{s}$
$t_f$	Fall Time			1.9		$\mu\text{s}$
$E_{off(**)}$	Turn-off Switching Loss			8.0		mJ

COLLECTOR-EMITTER DIODE

Symbol	Parameter	Test Conditions	Min.	Typ.	Max.	Unit
$I_f$	Forward Current				7	A
$I_{fm}$	Forward Current pulsed				56	A
$V_f$	Forward On-Voltage	$I_f = 3.5\text{ A}$ $I_f = 3.5\text{ A}, T_j = 125\text{ }^\circ\text{C}$		1.4 1.15	1.9	V V
$t_{rr}$	Reverse Recovery Time	$I_f = 7\text{ A}, V_R = 35\text{ V},$ $T_j = 125\text{ }^\circ\text{C}, di/dt = 100\text{ A}/\mu\text{s}$		50		ns
$Q_{rr}$	Reverse Recovery Charge			70		nC
$I_{rrm}$	Reverse Recovery Current			2.7		A

(●) Pulsed: Pulse duration = 300  $\mu\text{s}$ , duty cycle 1.5 %.

(1) Pulse width limited by max. junction temperature.

(\*\*) Losses Include Also the Tail

Switching Off Safe Operating Area

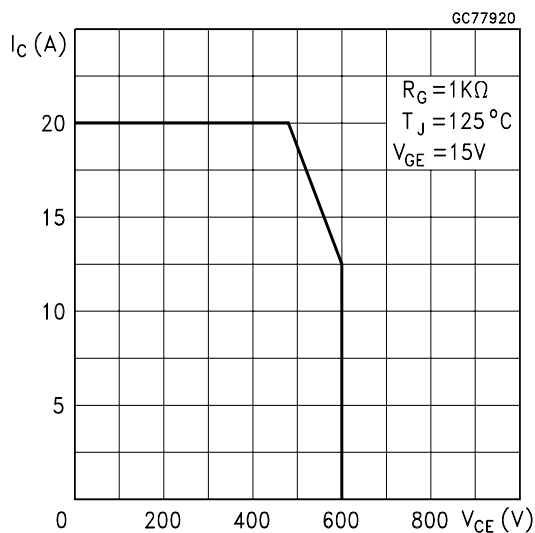

Thermal Impedance

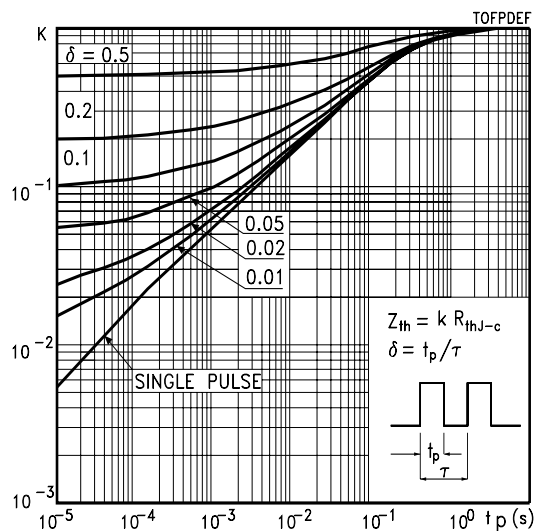

Output Characteristics

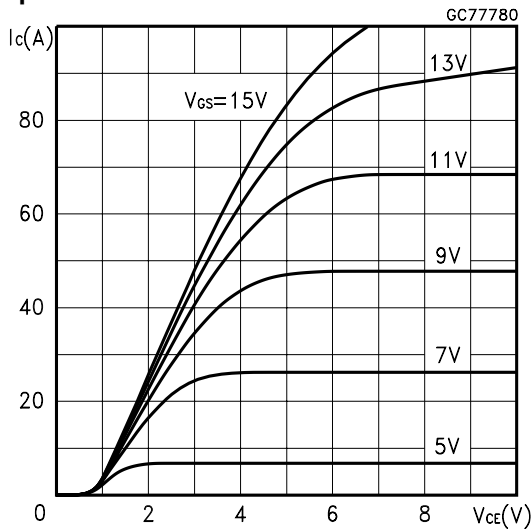

Transfer Characteristics

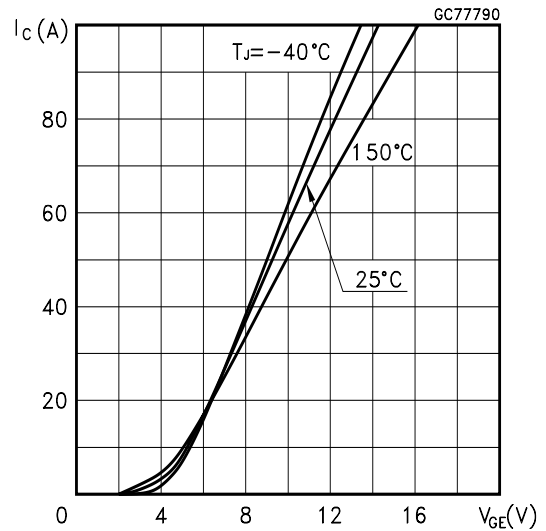

Transconductance

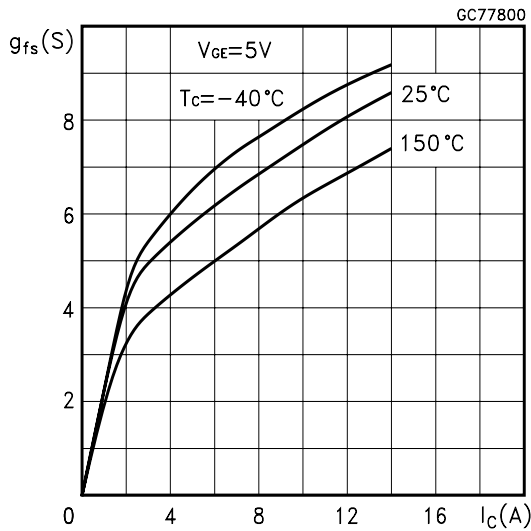

Collector-Emitter On Voltage vs Temperature

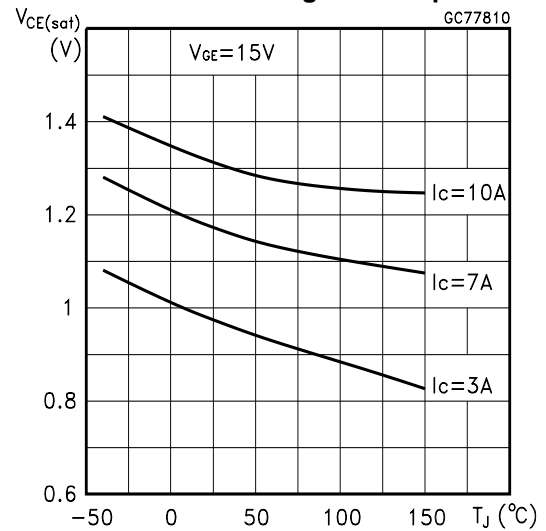

Collector-Emitter On Voltage vs Collector Current

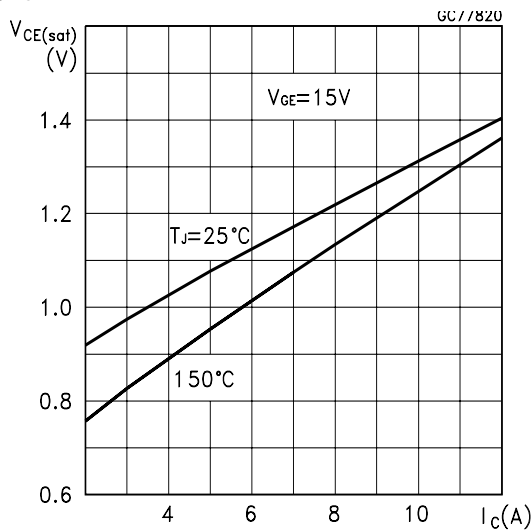

Gate Threshold Voltage vs Temperature

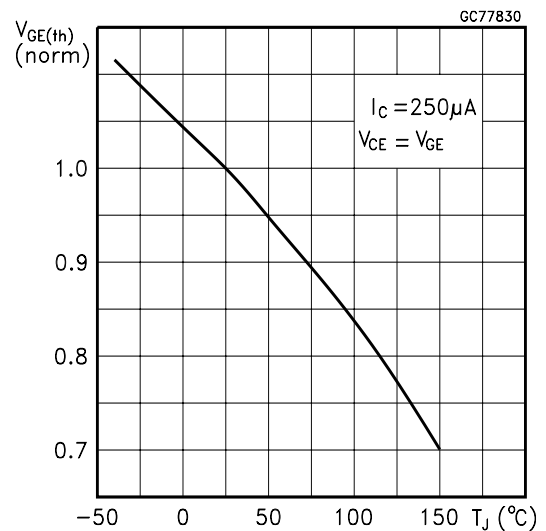

Capacitance Variations

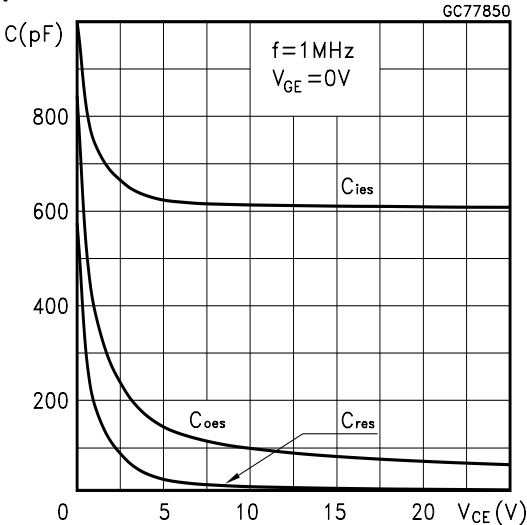

Gate Charge vs Gate-Emitter Voltage

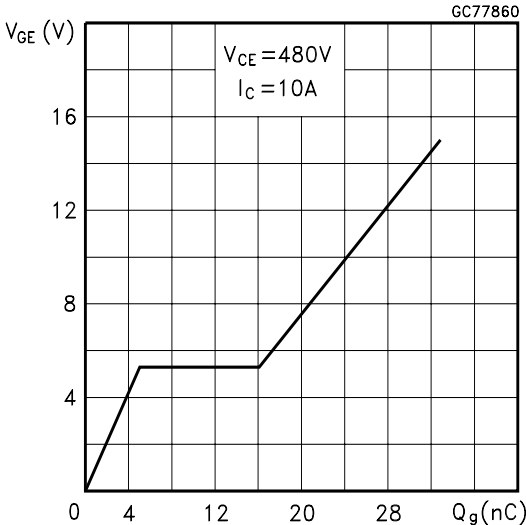

Off Losses vs Gate Resistance

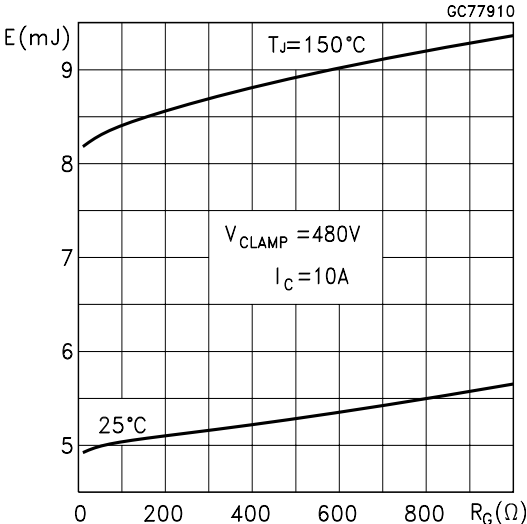

Off Losses vs Collector Current

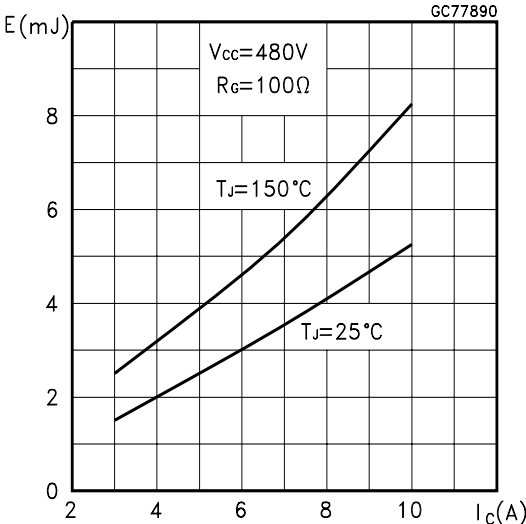

Normalized Break-down Voltage vs Temp.

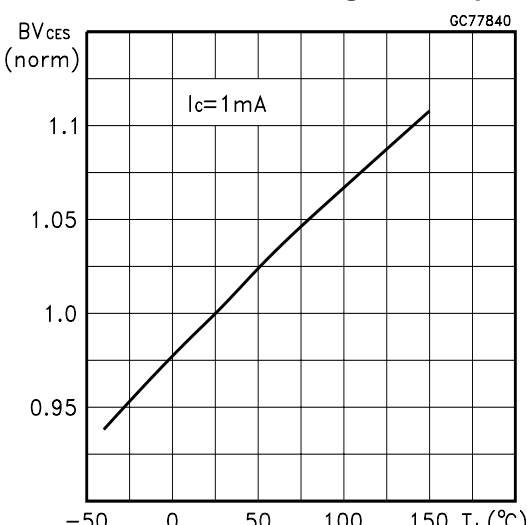

Off Losses vs Temperature

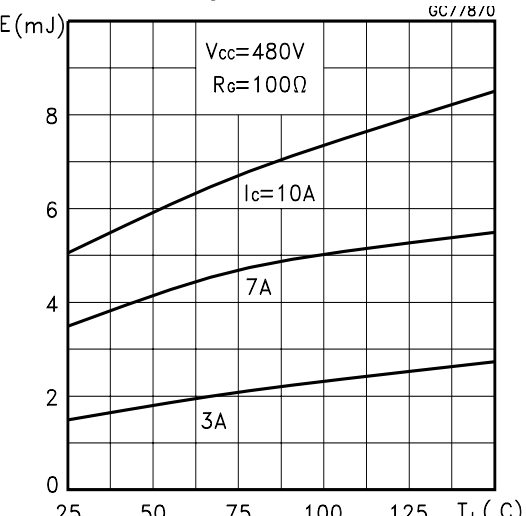

Emitter-Collector Diode Characteristics

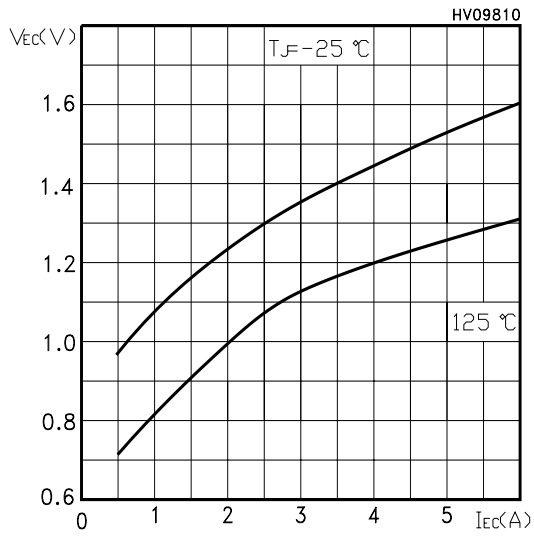

Fig. 1: Gate Charge test Circuit

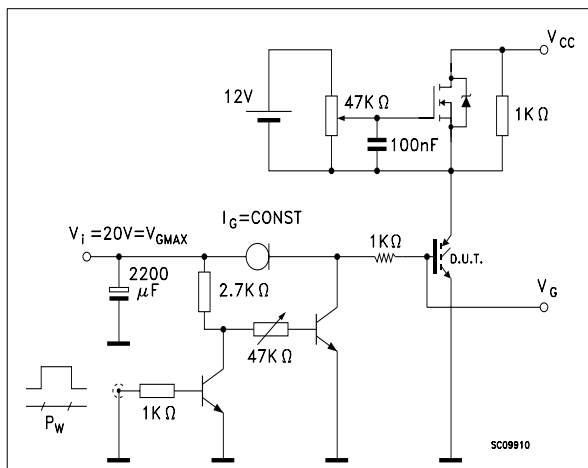
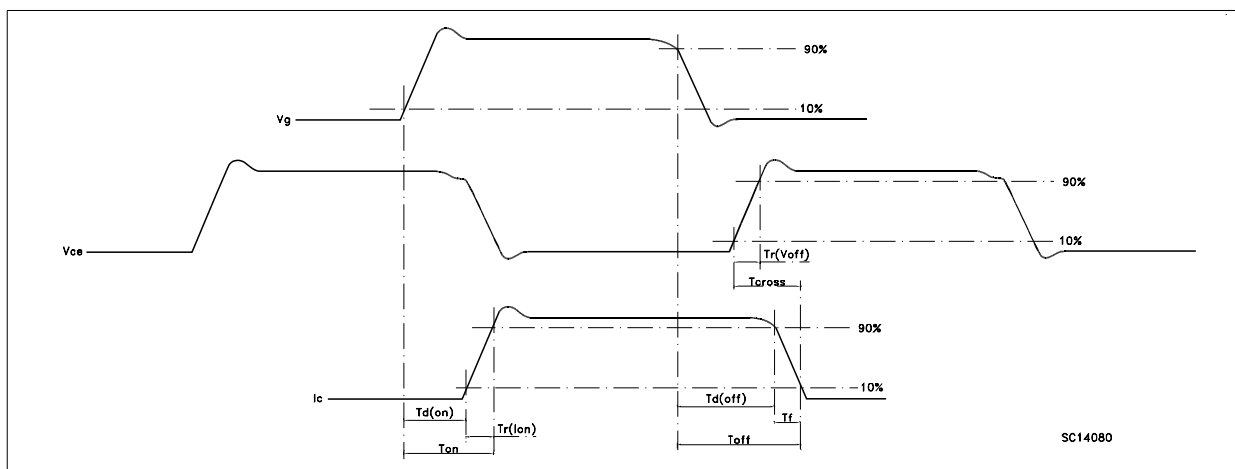
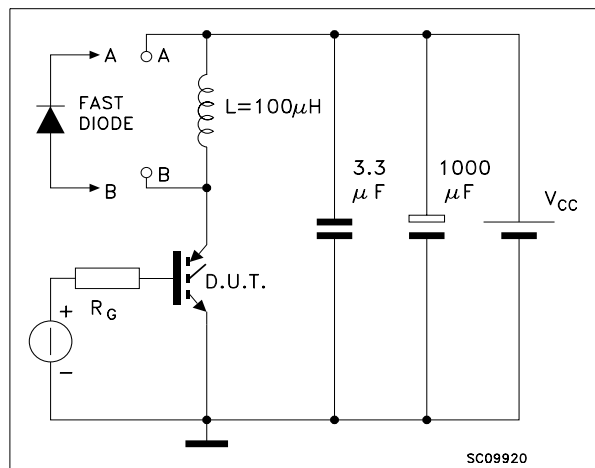
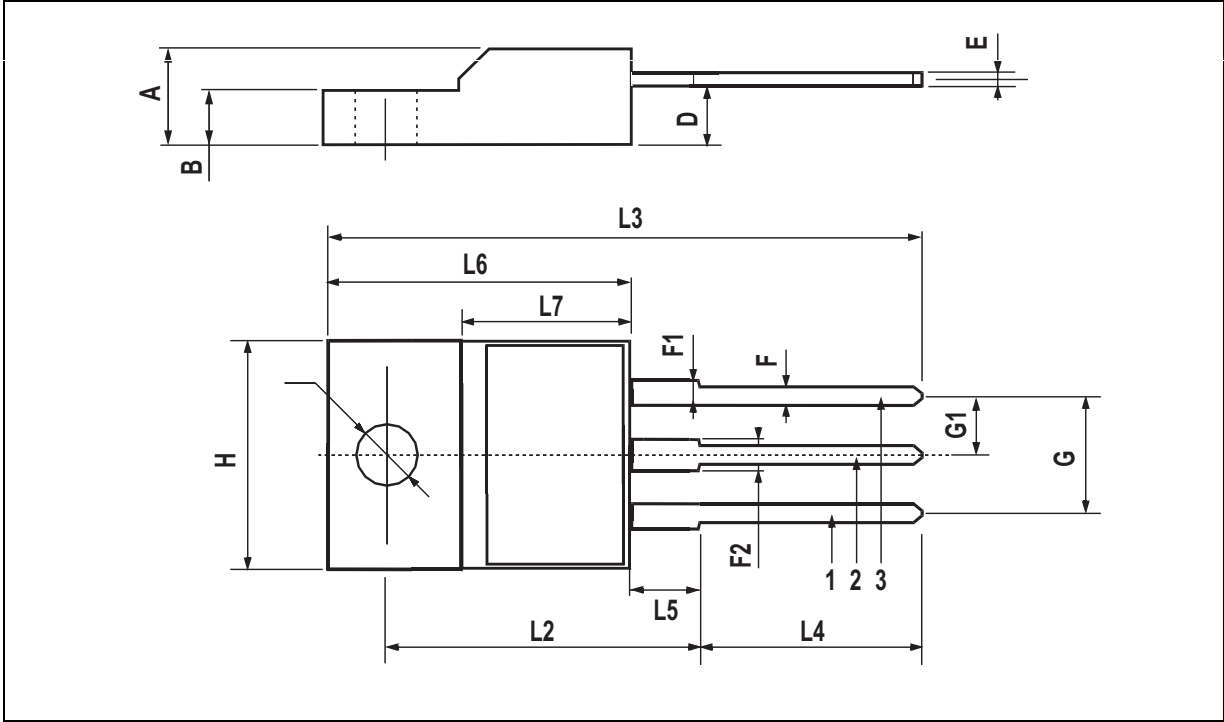

Fig. 2: Test Circuit For Inductive Load Switching (SC09920)



**TO-220FP MECHANICAL DATA**

DIM.	mm.			inch		
	MIN.	TYP	MAX.	MIN.	TYP.	MAX.
A	4.4		4.6	0.173		0.181
B	2.5		2.7	0.098		0.106
D	2.5		2.75	0.098		0.108
E	0.45		0.7	0.017		0.027
F	0.75		1	0.030		0.039
F1	1.15		1.5	0.045		0.067
F2	1.15		1.5	0.045		0.067
G	4.95		5.2	0.195		0.204
G1	2.4		2.7	0.094		0.106
H	10		10.4	0.393		0.409
L2		16			0.630	
L3	28.6		30.6	1.126		1.204
L4	9.8		10.6	.0385		0.417
L5	2.9		3.6	0.114		0.141
L6	15.9		16.4	0.626		0.645
L7	9		9.3	0.354		0.366
Ø	3		3.2	0.118		0.126



Information furnished is believed to be accurate and reliable. However, STMicroelectronics assumes no responsibility for the consequences of use of such information nor for any infringement of patents or other rights of third parties which may result from its use. No license is granted by implication or otherwise under any patent or patent rights of STMicroelectronics. Specifications mentioned in this publication are subject to change without notice. This publication supersedes and replaces all information previously supplied. STMicroelectronics products are not authorized for use as critical components in life support devices or systems without express written approval of STMicroelectronics.

© The ST logo is a registered trademark of STMicroelectronics

© 2002 STMicroelectronics - Printed in Italy - All Rights Reserved  
STMicroelectronics GROUP OF COMPANIES

Australia - Brazil - Canada - China - Finland - France - Germany - Hong Kong - India - Israel - Italy - Japan - Malaysia - Malta - Morocco  
Singapore - Spain - Sweden - Switzerland - United Kingdom - United States.

© <http://www.st.com>