



STP4NB100 STP4NB100FP

N - CHANNEL 1000V - 4Ω - 3.8A - TO-220/TO-220FP PowerMESH™ MOSFET

TYPE	V _{DSS}	R _{DS(on)}	I _D
STP4NB100	1000 V	< 4.4 Ω	3.8 A
STP4NB100FP	1000 V	< 4.4 Ω	3.8 A

- TYPICAL R_{DS(on)} = 4 Ω
- EXTREMELY HIGH dv/dt CAPABILITY
- 100% AVALANCHE TESTED
- VERY LOW INTRINSIC CAPACITANCES
- GATE CHARGE MINIMIZED

DESCRIPTION

Using the latest high voltage MESH OVERLAY™ process, STMicroelectronics has designed an advanced family of power MOSFETs with outstanding performances. The new patent pending strip layout coupled with the Company's proprietary edge termination structure, gives the lowest R_{DS(on)} per area, exceptional avalanche and dv/dt capabilities and unrivalled gate charge and switching characteristics.

APPLICATIONS

- HIGH CURRENT, HIGH SPEED SWITCHING
- SWITCH MODE POWER SUPPLIES (SMPS)
- DC-AC CONVERTERS FOR WELDING EQUIPMENT AND UNINTERRUPTIBLE POWER SUPPLIES AND MOTOR DRIVE

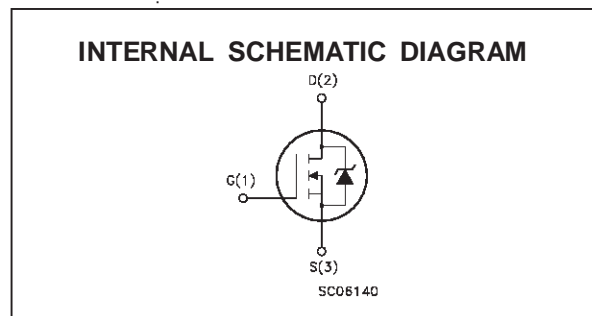
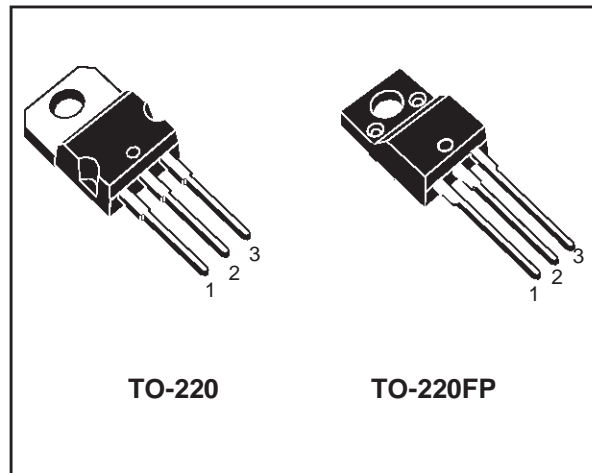

ABSOLUTE MAXIMUM RATINGS

Symbol	Parameter	Value		Unit
		STP4NB100	STP4NB100FP	
V _{DS}	Drain-source Voltage (V _{GS} = 0)	1000		V
V _{DGR}	Drain- gate Voltage (R _{GS} = 20 kΩ)	1000		V
V _{GS}	Gate-source Voltage	± 30		V
I _D	Drain Current (continuous) at T _c = 25 °C	3.8	3.8(*)	A
I _D	Drain Current (continuous) at T _c = 100 °C	2.4	2.4(*)	A
I _{DM} (●)	Drain Current (pulsed)	15.2	15.2	A
P _{tot}	Total Dissipation at T _c = 25 °C	125	40	W
	Derating Factor	1	0.32	W/°C
dv/dt(1)	Peak Diode Recovery voltage slope	4	4	V/ns
V _{ISO}	Insulation Withstand Voltage (DC)	—	2000	V
T _{stg}	Storage Temperature	-65 to 150		°C
T _j	Max. Operating Junction Temperature	150		°C

(●) Pulse width limited by safe operating area

(*) Limited only by maximum temperature allowed

(1) I_{SD} ≤ 3.8A, di/dt ≤ 200 A/μs, V_{DD} ≤ V_{(BR)DSS}, T_j ≤ T_{JMAX}

STP4NB100/STP4NB100FP

THERMAL DATA

			TO-220	TO-220FP	
R _{thj-case}	Thermal Resistance Junction-case	Max	1	3.12	°C/W
R _{thj-amb}	Thermal Resistance Junction-ambient	Max	62.5		°C/W
R _{thc-sink}	Thermal Resistance Case-sink	Typ	0.5		°C/W
T _l	Maximum Lead Temperature For Soldering Purpose		300		°C

AVALANCHE CHARACTERISTICS

Symbol	Parameter	Max Value	Unit
I _{AR}	Avalanche Current, Repetitive or Not-Repetitive (pulse width limited by T _j max)	3.8	A
E _{AS}	Single Pulse Avalanche Energy (starting T _j = 25 °C, I _D = I _{AR} , V _{DD} = 50 V)	360	mJ

ELECTRICAL CHARACTERISTICS (T_{case} = 25 °C unless otherwise specified)

OFF

Symbol	Parameter	Test Conditions	Min.	Typ.	Max.	Unit
V _{(BR)DSS}	Drain-source Breakdown Voltage	I _D = 250 μA V _{GS} = 0	1000			V
I _{DSS}	Zero Gate Voltage Drain Current (V _{GS} = 0)	V _{DS} = Max Rating V _{DS} = Max Rating T _c = 125 °C			1 50	μA μA
I _{GSS}	Gate-body Leakage Current (V _{DS} = 0)	V _{GS} = ± 30 V			± 100	nA

ON (*)

Symbol	Parameter	Test Conditions	Min.	Typ.	Max.	Unit
V _{GS(th)}	Gate Threshold Voltage	V _{DS} = V _{GS} I _D = 250 μA	3	4	5	V
R _{DS(on)}	Static Drain-source On Resistance	V _{GS} = 10 V I _D = 2 A		4	4.4	Ω
I _{D(on)}	On State Drain Current	V _{DS} > I _{D(on)} × R _{DS(on)max} V _{GS} = 10 V	3.8			A

DYNAMIC

Symbol	Parameter	Test Conditions	Min.	Typ.	Max.	Unit
g _{fs} (*)	Forward Transconductance	V _{DS} > I _{D(on)} × R _{DS(on)max} I _D = 2 A	1.5	3		S
C _{iss}	Input Capacitance	V _{DS} = 25 V f = 1 MHz V _{GS} = 0		1400		pF
C _{oss}	Output Capacitance			117		pF
C _{rss}	Reverse Transfer Capacitance			7		pF

ELECTRICAL CHARACTERISTICS (continued)

SWITCHING ON

Symbol	Parameter	Test Conditions	Min.	Typ.	Max.	Unit
$t_{d(on)}$	Turn-on Time	$V_{DD} = 500\text{ V}$ $I_D = 2\text{ A}$ $R_G = 4.7\ \Omega$ $V_{GS} = 10\text{ V}$ (see test circuit, figure 3)		20		ns
t_r	Rise Time			9		ns
Q_g	Total Gate Charge	$V_{DD} = 800\text{ V}$ $I_D = 4\text{ A}$ $V_{GS} = 10\text{ V}$		32	45	nC
Q_{gs}	Gate-Source Charge			12		nC
Q_{gd}	Gate-Drain Charge			11		nC

SWITCHING OFF

Symbol	Parameter	Test Conditions	Min.	Typ.	Max.	Unit
$t_r(V_{off})$	Off-voltage Rise Time	$V_{DD} = 800\text{ V}$ $I_D = 4\text{ A}$ $R_G = 4.7\ \Omega$ $V_{GS} = 10\text{ V}$ (see test circuit, figure 5)		15		ns
t_f	Fall Time			12		ns
t_c	Cross-over Time			20		ns

SOURCE DRAIN DIODE

Symbol	Parameter	Test Conditions	Min.	Typ.	Max.	Unit
I_{SD}	Source-drain Current				3.8	A
$I_{SDM}(\bullet)$	Source-drain Current (pulsed)				15.2	A
$V_{SD}(\ast)$	Forward On Voltage	$I_{SD} = 3.8\text{ A}$ $V_{GS} = 0$			1.6	V
t_{rr}	Reverse Recovery Time	$I_{SD} = 4\text{ A}$ $di/dt = 100\text{ A}/\mu\text{s}$ $V_{DD} = 100\text{ V}$ $T_j = 150\text{ }^\circ\text{C}$ (see test circuit, figure 5)		750		ns
Q_{rr}	Reverse Recovery Charge			5.4		μC
I_{RRM}	Reverse Recovery Current			14.5		A

(*) Pulsed: Pulse duration = 300 μs , duty cycle 1.5 %

(•) Pulse width limited by safe operating area

Safe Operating Area for TO-220

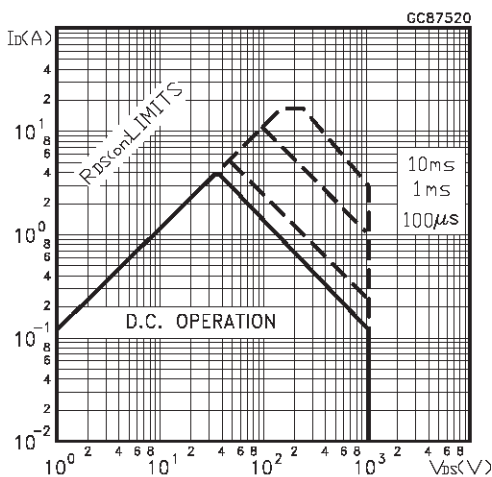

Safe Operating Area for TO-220FP

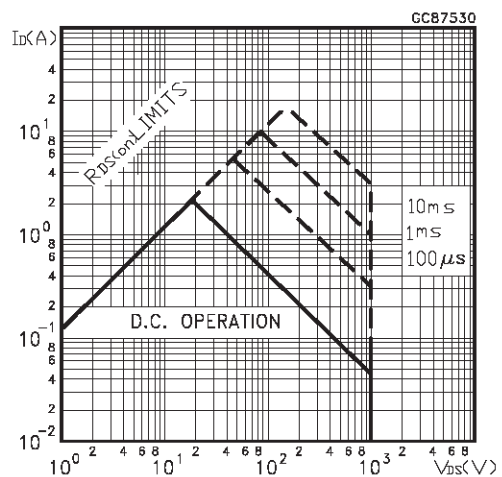

STP4NB100/STP4NB100FP

Thermal Impedance for TO-220

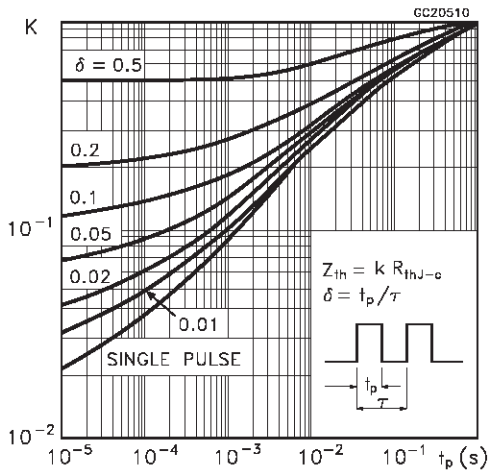

Thermal Impedance for TO-220FP

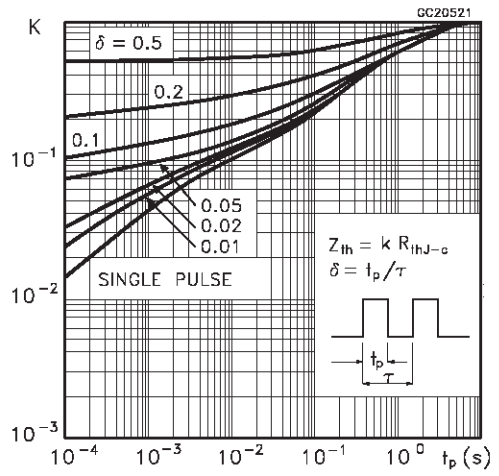

Output Characteristics

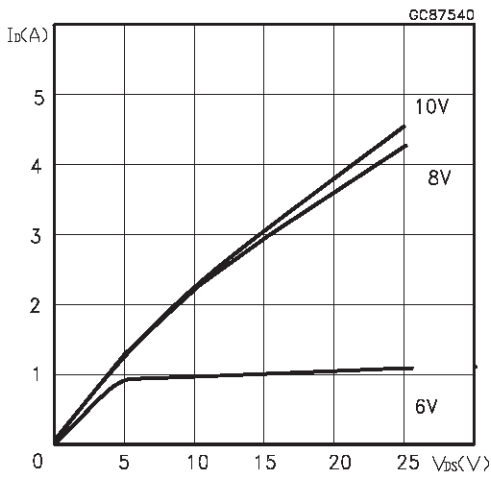

Transfer Characteristics

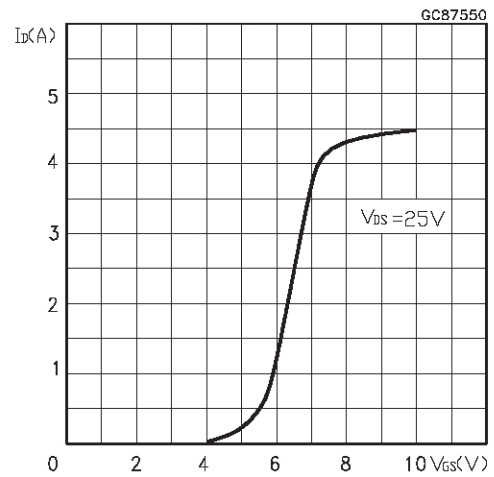

Transconductance

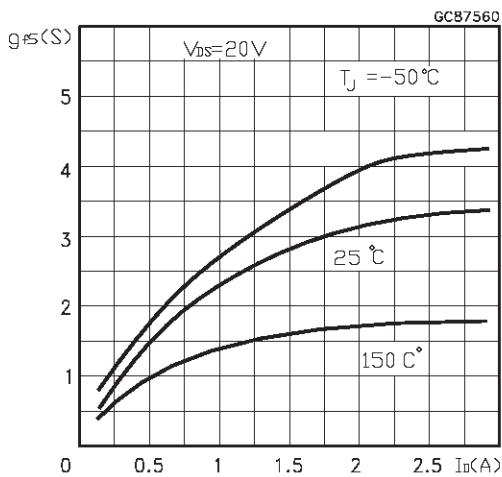

Static Drain-source On Resistance

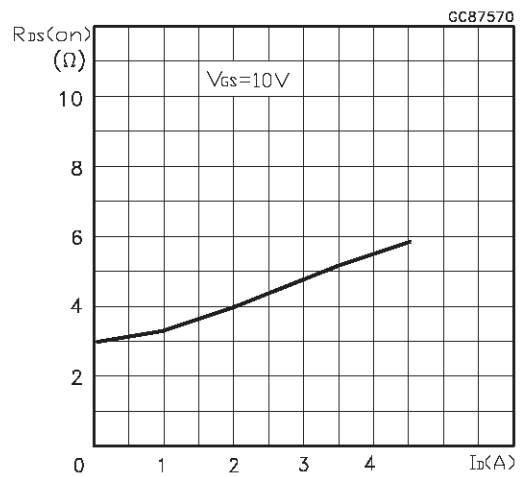

Gate Charge vs Gate-source Voltage

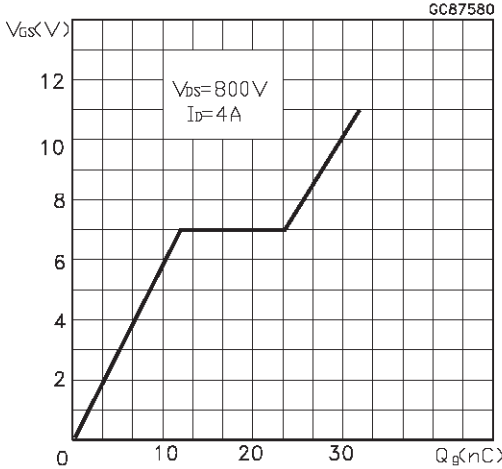

Capacitance Variations

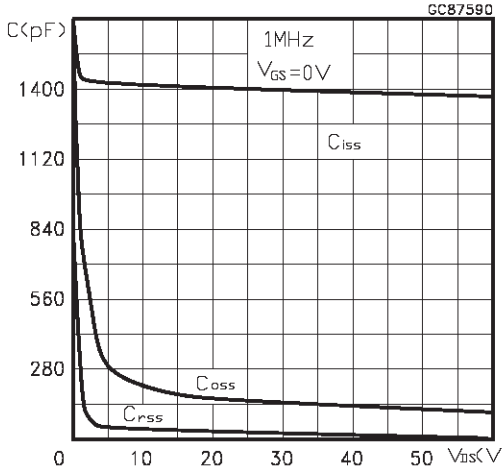

Normalized Gate Threshold Voltage vs Temperature

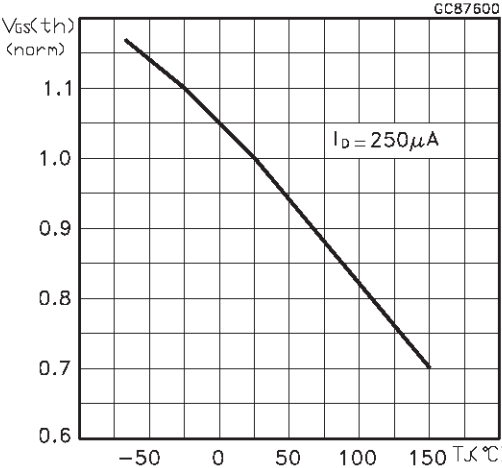

Normalized On Resistance vs Temperature

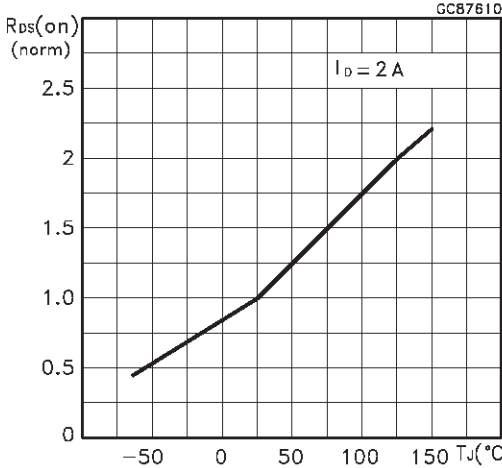

Source-drain Diode Forward Characteristics

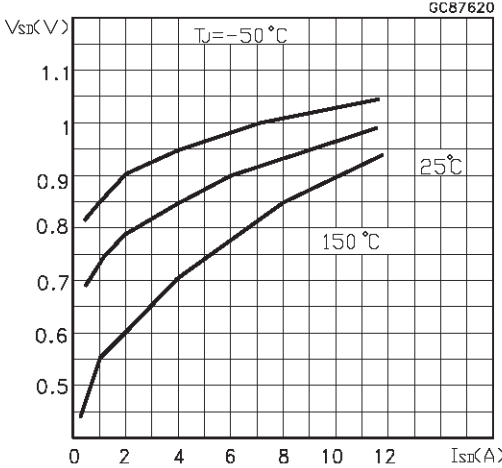

Fig. 1: Unclamped Inductive Load Test Circuit



Fig. 2: Unclamped Inductive Waveform



Fig. 3: Switching Times Test Circuits For Resistive Load



Fig. 4: Gate Charge test Circuit

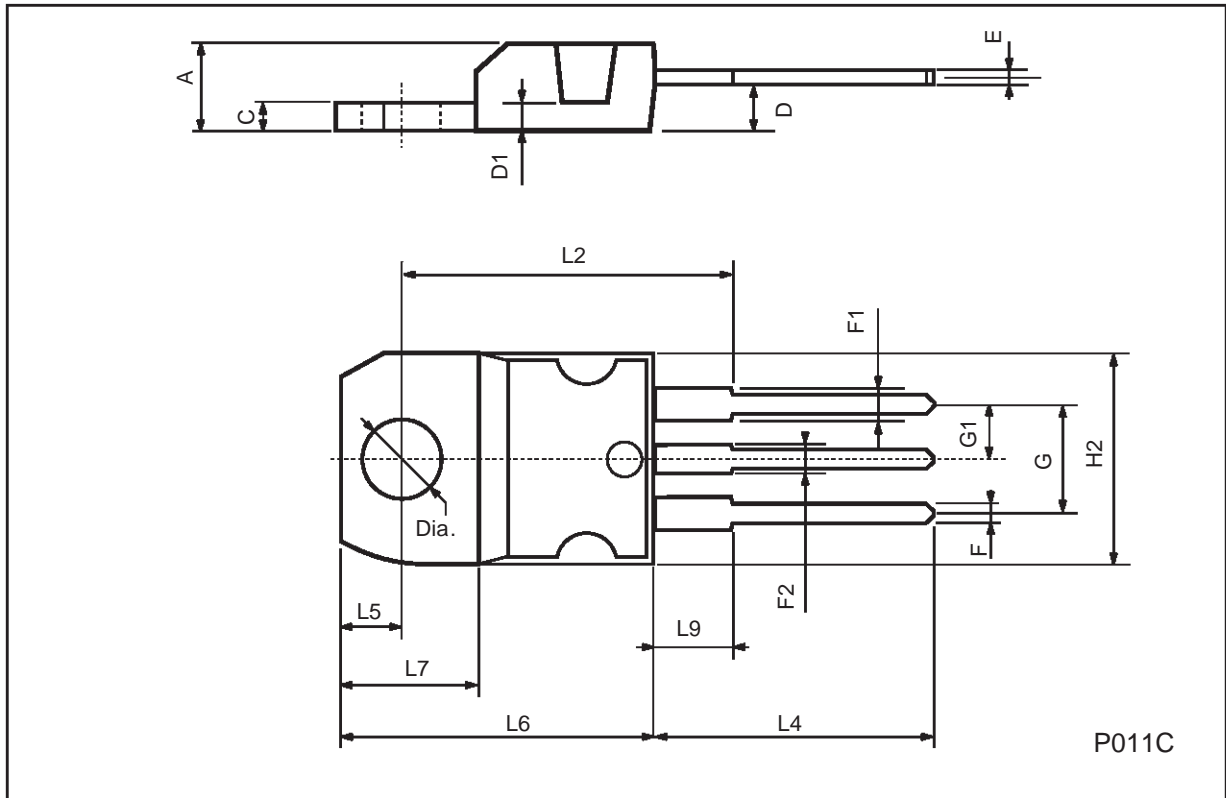

Fig. 5: Test Circuit For Inductive Load Switching And Diode Recovery Times



TO-220 MECHANICAL DATA

DIM.	mm			inch		
	MIN.	TYP.	MAX.	MIN.	TYP.	MAX.
A	4.40		4.60	0.173		0.181
C	1.23		1.32	0.048		0.051
D	2.40		2.72	0.094		0.107
D1		1.27			0.050	
E	0.49		0.70	0.019		0.027
F	0.61		0.88	0.024		0.034
F1	1.14		1.70	0.044		0.067
F2	1.14		1.70	0.044		0.067
G	4.95		5.15	0.194		0.203
G1	2.4		2.7	0.094		0.106
H2	10.0		10.40	0.393		0.409
L2		16.4			0.645	
L4	13.0		14.0	0.511		0.551
L5	2.65		2.95	0.104		0.116
L6	15.25		15.75	0.600		0.620
L7	6.2		6.6	0.244		0.260
L9	3.5		3.93	0.137		0.154
DIA.	3.75		3.85	0.147		0.151



TO-220FP MECHANICAL DATA

DIM.	mm			inch		
	MIN.	TYP.	MAX.	MIN.	TYP.	MAX.
A	4.4		4.6	0.173		0.181
B	2.5		2.7	0.098		0.106
D	2.5		2.75	0.098		0.108
E	0.45		0.7	0.017		0.027
F	0.75		1	0.030		0.039
F1	1.15		1.7	0.045		0.067
F2	1.15		1.7	0.045		0.067
G	4.95		5.2	0.195		0.204
G1	2.4		2.7	0.094		0.106
H	10		10.4	0.393		0.409
L2		16			0.630	
L3	28.6		30.6	1.126		1.204
L4	9.8		10.6	0.385		0.417
L6	15.9		16.4	0.626		0.645
L7	9		9.3	0.354		0.366
Ø	3		3.2	0.118		0.126

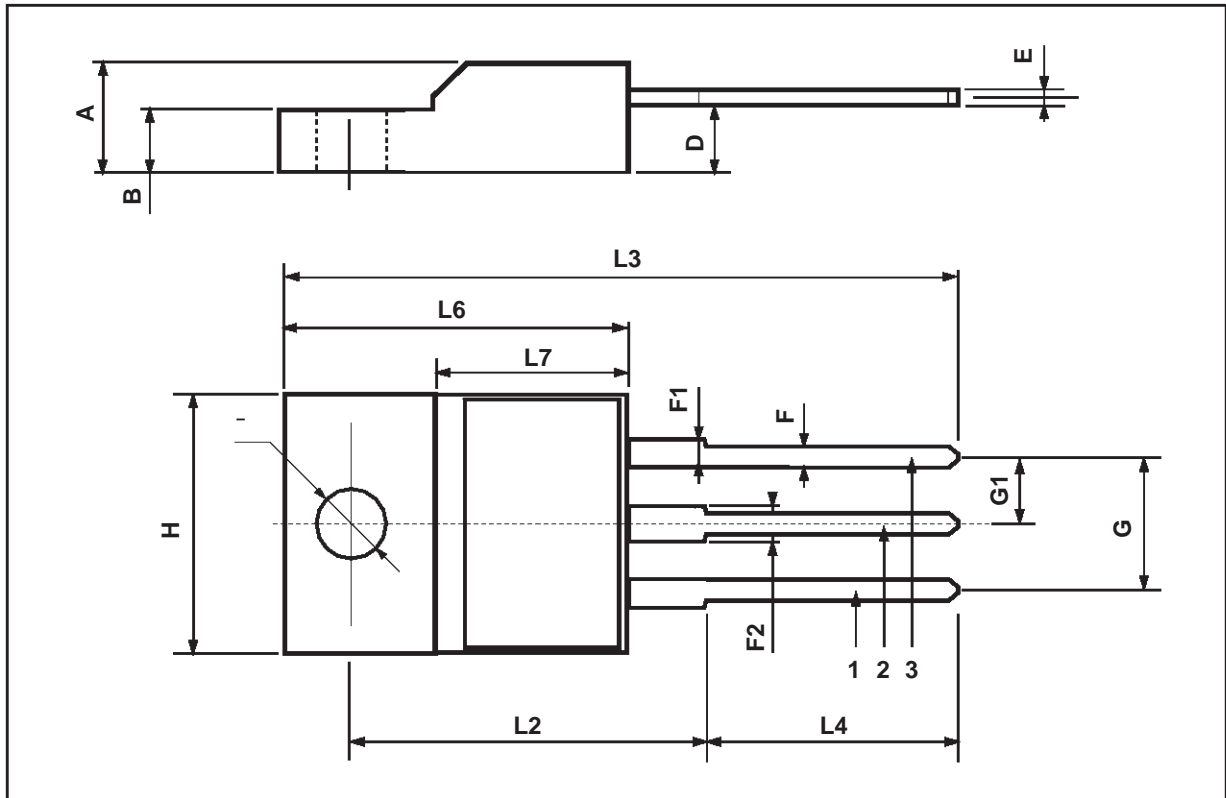

Information furnished is believed to be accurate and reliable. However, STMicroelectronics assumes no responsibility for the consequences of use of such information nor for any infringement of patents or other rights of third parties which may result from its use. No license is granted by implication or otherwise under any patent or patent rights of STMicroelectronics. Specification mentioned in this publication are subject to change without notice. This publication supersedes and replaces all information previously supplied. STMicroelectronics products are not authorized for use as critical components in life support devices or systems without express written approval of STMicroelectronics.

The ST logo is a trademark of STMicroelectronics

© 1999 STMicroelectronics – Printed in Italy – All Rights Reserved
STMicroelectronics GROUP OF COMPANIES

Australia - Brazil - China - Finland - France - Germany - Hong Kong - India - Italy - Japan - Malaysia - Malta - Morocco -
Singapore - Spain - Sweden - Switzerland - United Kingdom - U.S.A.

<http://www.st.com>

