

$I_{F(AV)} = 40\text{Amp}$
 $V_R = 15\text{V}$

Major Ratings and Characteristics

Characteristics	Values	Units
$I_{F(AV)}$ Rectangular waveform	40	A
V_{RRM}	15	V
I_{FSM} @tp = 5 μ s sine	700	A
V_F @ 19 Apk, $T_J = 125^\circ\text{C}$ (per leg, Typical)	0.25	V
T_J	-55 to 125	$^\circ\text{C}$

Description/ Features

The center tap Schottky rectifier module has been optimized for ultra low forward voltage drop specifically for the OR-ing of parallel power supplies. The proprietary barrier technology allows for reliable operation up to 125 $^\circ\text{C}$ junction temperature. Typical applications are in parallel switching power supplies, converters, reverse battery protection, and redundant power subsystems.

- 125 $^\circ\text{C}$ T_J operation ($V_R < 5\text{V}$)
- Center tap module
- Optimized for OR-ing applications
- Ultra low forward voltage drop
- High frequency operation
- Guard ring for enhanced ruggedness and long term reliability
- High purity, high temperature epoxy encapsulation for enhanced mechanical strength and moisture resistance
- Lead-Free ("PbF" suffix)

Case Styles



TO-220

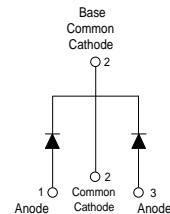

Voltage Ratings

Part number	Values
V_R Max. DC Reverse Voltage (V) @ $T_J = 100^\circ\text{C}$	15
V_{RWM} Max. Working Peak Reverse Voltage (V) @ $T_J = 100^\circ\text{C}$	

Absolute Maximum Ratings

Parameters	Values	Units	Conditions
$I_{F(AV)}$ Max. Average Forward (Per Leg) Current * See Fig. 5 (Per Device)	20	A	50% duty cycle @ $T_C = 85^\circ\text{C}$, rectangular wave form
	40		
I_{FSM} Max. Peak One Cycle Non-Repetitive Surge Current (Per Leg) * See Fig. 7	700	A	5 μs Sine or 3 μs Rect. pulse 10ms Sine or 6ms Rect. pulse Following any rated load condition and with rated V_{RWM} applied
	330		
E_{AS} Non-Repetitive Avalanche Energy (Per Leg)	10	mJ	$T_J = 25^\circ\text{C}$, $I_{AS} = 2\text{ Amps}$, $L = 6\text{ mH}$
I_{AR} Repetitive Avalanche Current (Per Leg)	2	A	Current decaying linearly to zero in 1 μsec Frequency limited by T_J max. $V_A = 1.5 \times V_R$ typical

Electrical Specifications

Parameters	Values		Units	Conditions	
	Typ.	Max.			
V_{FM} Forward Voltage Drop (Per Leg) * See Fig. 1 (1)	-	0.41	V	@ 19A	$T_J = 25^\circ\text{C}$
	-	0.52	V	@ 40A	
	0.25	0.33	V	@ 19A	$T_J = 125^\circ\text{C}$
	0.37	0.50	V	@ 40A	
I_{RM} Reverse Leakage Current (Per Leg) * See Fig. 2 (1)	-	10	mA	$T_J = 25^\circ\text{C}$	$V_R = \text{rated } V_R$
	-	600	mA	$T_J = 100^\circ\text{C}$	
$V_{F(TO)}$ Threshold Voltage	0.182		V	$T_J = T_J \text{ max.}$	
r_t Forward Slope Resistance	7.6		m Ω		
C_T Max. Junction Capacitance (Per Leg)	-	2000	pF	$V_R = 5V_{DC}$ (test signal range 100Khz to 1Mhz) 25°C	
L_S Typical Series Inductance (Per Leg)	8	-	nH	Measured lead to lead 5mm from package body	
dv/dt Max. Voltage Rate of Change (Rated V_R)	10000		V/ μs		

(1) Pulse Width < 300 μs , Duty Cycle <2%

Thermal-Mechanical Specifications

Parameters	Values	Units	Conditions
T_J Max. Junction Temperature Range	-55 to 125	$^\circ\text{C}$	
T_{stg} Max. Storage Temperature Range	-55 to 150	$^\circ\text{C}$	
R_{thJC} Max. Thermal Resistance Junction to Case (Per Leg)	1.5	$^\circ\text{C/W}$	DC operation * See Fig. 4
R_{thCS} Typical Thermal Resistance Case to Heatsink	0.50	$^\circ\text{C/W}$	Mounting surface, smooth and greased Only for TO-220
R_{thJA} Max. Thermal Resistance Junction to Ambient	40	$^\circ\text{C/W}$	DC operation For D ² Pak and TO-262
wt Approximate Weight	2 (0.07)	g (oz.)	
T Mounting Torque	Min.	6 (5)	Non-lubricated threads
	Max.	12 (10)	
Marking Device	STPS40L15CT		

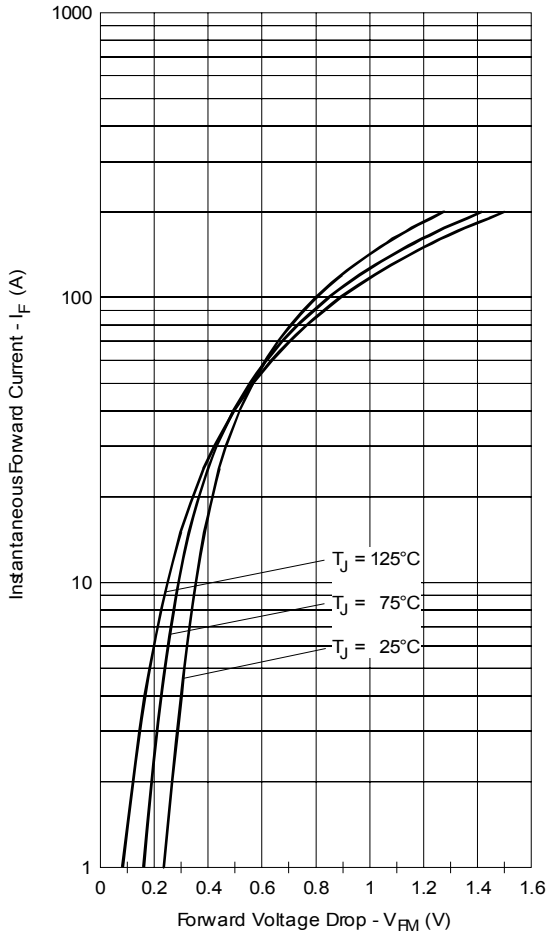

Fig. 1 - Maximum Forward Voltage Drop Characteristics

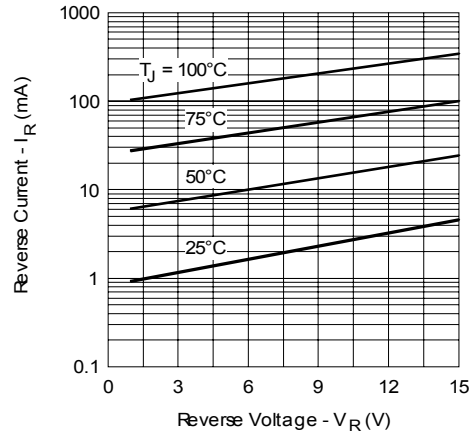

Fig. 2 - Typical Values of Reverse Current Vs. Reverse Voltage

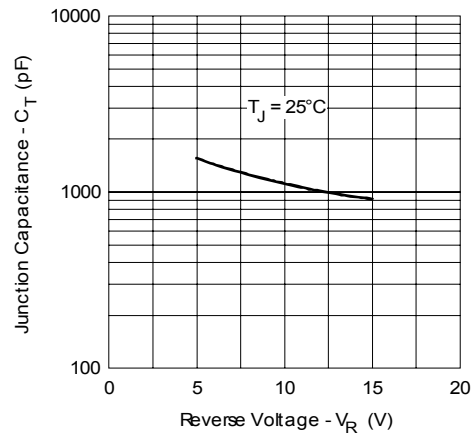

Fig. 3 - Typical Junction Capacitance Vs. Reverse Voltage

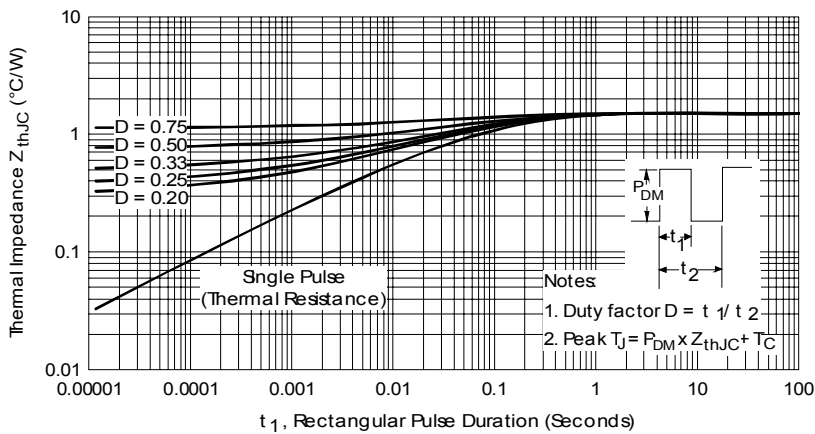

Fig. 4 - Maximum Thermal Impedance Z_{thJC} Characteristics

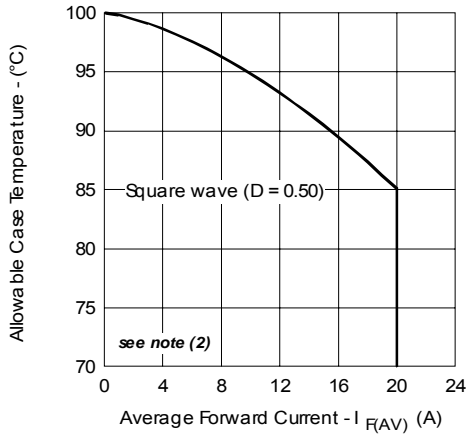

Fig. 5 - Maximum Allowable Case Temperature Vs. Average Forward Current

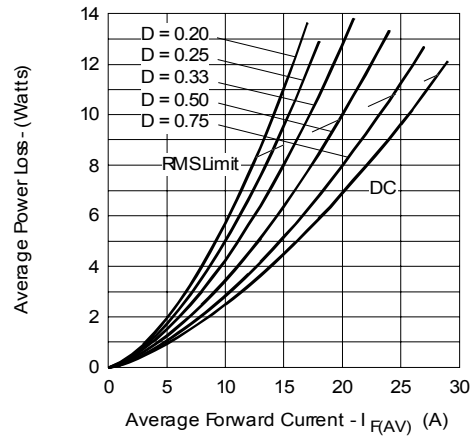

Fig. 6 - Forward Power Loss Characteristics

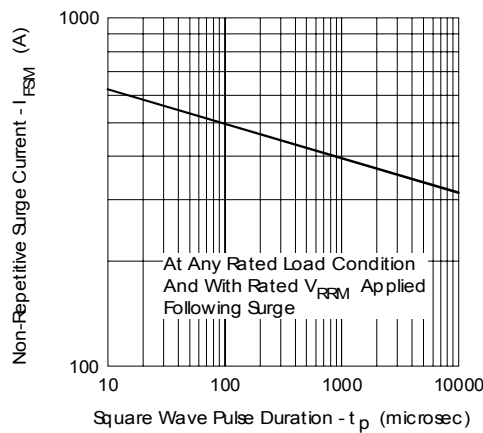

Fig. 7 - Maximum Non-Repetitive Surge Current

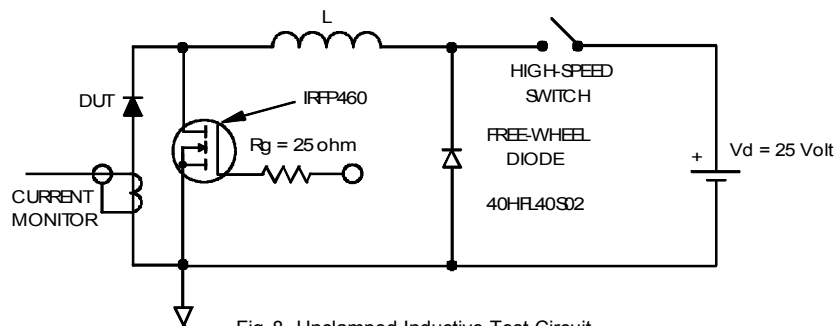

Fig. 8 - Unclamped Inductive Test Circuit

(2) Formula used: $T_c = T_j - (Pd + Pd_{REV}) \times R_{thJC}$

Pd = Forward Power Loss = $I_{F(AV)} \times V_{FM} @ (I_{F(AV)} / D)$ (see Fig. 6);

Pd_{REV} = Inverse Power Loss = $V_{R1} \times I_{R1} (1 - D)$; $I_{R1} @ V_{R1} = 80\%$ rated V_R

Outline Table

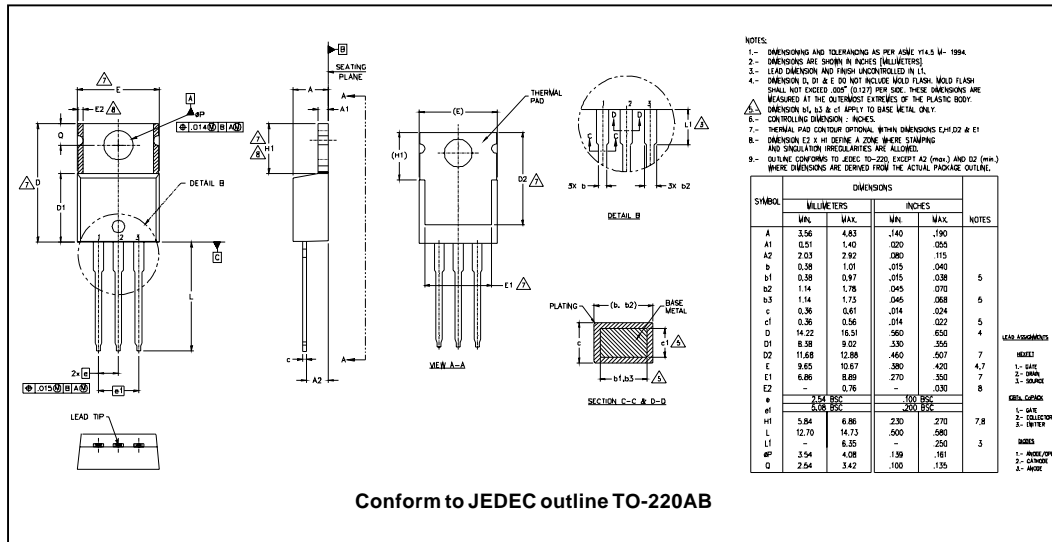

Part Marking Information

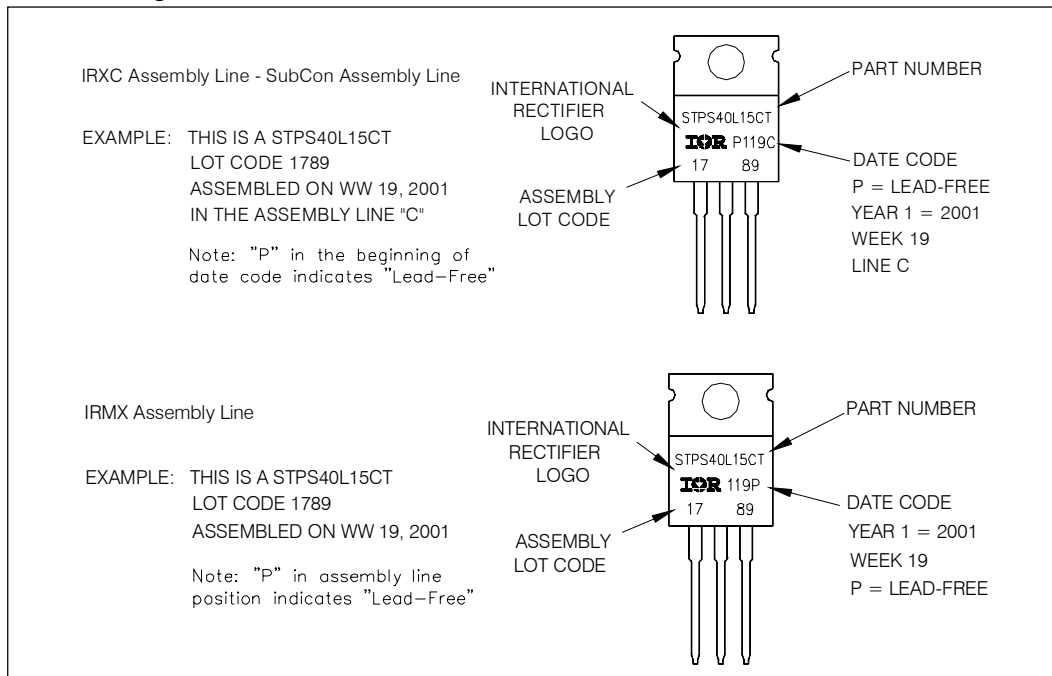

Ordering Information Table

Device Code													
	<table border="1"> <tr> <td>STPS</td> <td>40</td> <td>L</td> <td>15</td> <td>CT</td> <td>PbF</td> </tr> <tr> <td>①</td> <td>②</td> <td>③</td> <td>④</td> <td>⑤</td> <td>⑥</td> </tr> </table>	STPS	40	L	15	CT	PbF	①	②	③	④	⑤	⑥
STPS	40	L	15	CT	PbF								
①	②	③	④	⑤	⑥								
1	- Schottky STPS Series												
2	- Current Rating (40 = 40A)												
3	- L = Low Voltage Drop												
4	- Voltage Rating (15 = 15V)												
5	- CT = Essential Part Number												
6	<ul style="list-style-type: none"> • none = Standard Production • PbF = Lead-Free 												

Data and specifications subject to change without notice.
 This product has been designed and qualified for Industrial Level and Lead-Free.
 Qualification Standards can be found on IR's Web site.

International
IR Rectifier

IR WORLD HEADQUARTERS: 233 Kansas St., El Segundo, California 90245, USA Tel: (310) 252-7105
 TAC Fax: (310) 252-7309
 Visit us at www.irf.com for sales contact information. 02/07