



STS 2302S

SamHop Microelectronics Corp.

Sep. 3 2005

N-Channel Enhancement Mode Field Effect Transistor

PRODUCT SUMMARY		
V _{DSS}	I _D	R _{DS(ON)} (mΩ) Max
20V	4A	47 @ V _{GS} = 4.5V 60 @ V _{GS} = 2.5V

FEATURES

- Super high dense cell design for low R_{DS(ON)}.
- Rugged and reliable.
- SOT-23 package.

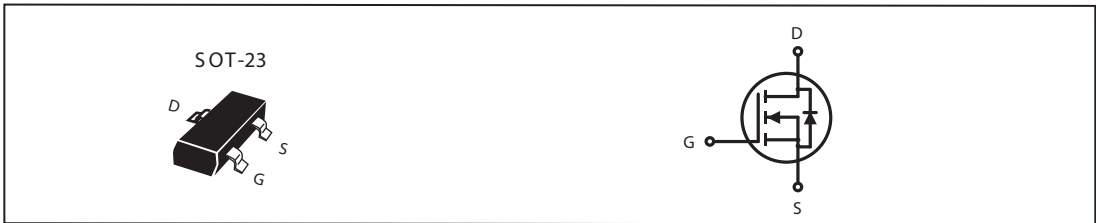

ABSOLUTE MAXIMUM RATING (T_A=25°C unless otherwise noted)

Parameter	Symbol	Limit	Unit
Drain-Source Voltage	V _{DS}	20	V
Gate-Source Voltage	V _{GS}	± 12	V
Drain Current-Continuous @ T _J =25°C -Pulsed ^b	I _D	4	A
	I _{DM}	15	A
Drain-Source Diode Forward Current	I _S	1.25	A
Maximum Power Dissipation ^a	P _D	1.25	W
Operating Junction and Storage Temperature Range	T _J , T _{STG}	-55 to 150	°C

THERMAL CHARACTERISTICS

Thermal Resistance, Junction-to-Ambient ^a	R _{thJA}	100	°C/W
--	-------------------	-----	------

STS 2302S

ELECTRICAL CHARACTERISTICS ($T_A = 25^\circ\text{C}$ unless otherwise noted)

Parameter	Symbol	Condition	Min	Typ ^c	Max	Unit
OFF CHARACTERISTICS						
Drain-Source Breakdown Voltage	BV_{DSS}	$V_{GS} = 0V, I_D = 250\mu A$	20			V
Zero Gate Voltage Drain Current	I_{DSS}	$V_{DS} = 16V, V_{GS} = 0V$			1	μA
Gate-Body Leakage	I_{GSS}	$V_{GS} = \pm 12V, V_{DS} = 0V$			± 100	nA
ON CHARACTERISTICS^b						
Gate Threshold Voltage	$V_{GS(th)}$	$V_{DS} = V_{GS}, I_D = 250\mu A$	0.5	0.8	1.3	V
Drain-Source On-State Resistance	$R_{DS(on)}$	$V_{GS} = 4.5V, I_D = 4A$		40	47	m-ohm
		$V_{GS} = 2.5V, I_D = 2A$		55	60	m-ohm
On-State Drain Current	$I_{D(on)}$	$V_{DS} = 5V, V_{GS} = 4.5V$	6			A
Forward Transconductance	g_{FS}	$V_{DS} = 5V, I_D = 3.8A$		19		S
DYNAMIC CHARACTERISTICS^c						
Input Capacitance	C_{ISS}	$V_{DS} = 15V, V_{GS} = 0V$ $f = 1.0MHz$		495		pF
Output Capacitance	C_{OSS}			88		pF
Reverse Transfer Capacitance	C_{RSS}			65		pF
SWITCHING CHARACTERISTICS^c						
Turn-On Delay Time	$t_{D(on)}$	$V_{DD} = 10V,$ $I_D = 1A,$ $V_{GS} = 4.5V,$ $R_{GEN} = 6\text{ ohm}$		12		ns
Rise Time	t_r			13		ns
Turn-Off Delay Time	$t_{D(off)}$			44		ns
Fall Time	t_f			18		ns
Total Gate Charge	Q_g	$V_{DS} = 10V, I_D = 4A,$ $V_{GS} = 4.5V$		6.8		nC
Gate-Source Charge	Q_{gs}			1.5		nC
Gate-Drain Charge	Q_{gd}			3		nC

STS 2302S

ELECTRICAL CHARACTERISTICS ($T_A=25^{\circ}\text{C}$ unless otherwise noted)

Parameter	Symbol	Condition	Min	Typ	Max	Unit
DRAIN-SOURCE DIODE CHARACTERISTICS^b						
Diode Forward Voltage	V_{SD}	$V_{GS} = 0V, I_s = 1.25A$		0.87	1.2	V

Notes

a. Surface mounted on FR-4 board, $t \leq 10$ sec

b. Pulse Test: Pulse Width $\leq 300\mu s$, Duty Cycle $\leq 2\%$.

c. Guaranteed by design, not subject to production testing.

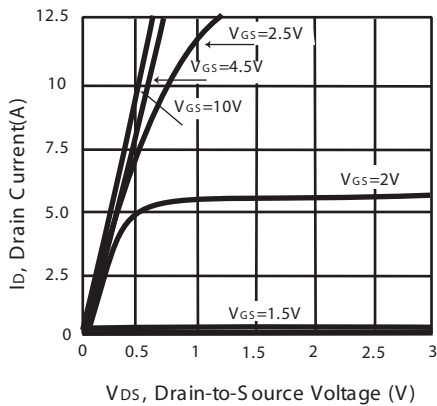

Figure 1. Output Characteristics

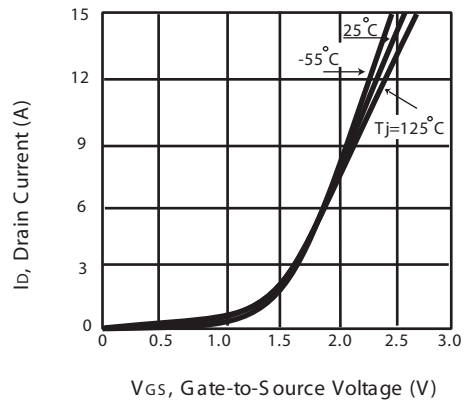

Figure 2. Transfer Characteristics

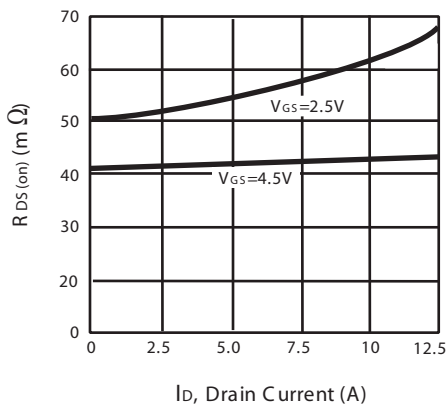

Figure 3. On-Resistance vs. Drain Current and Gate Voltage

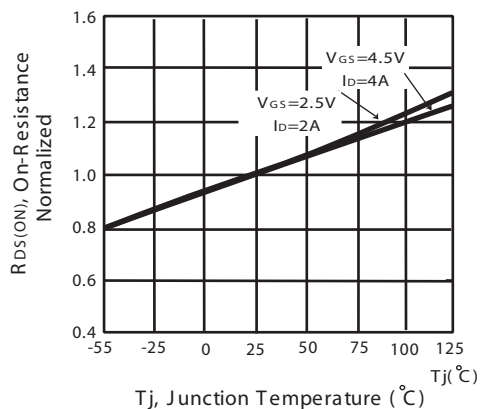

Figure 4. On-Resistance Variation with Drain Current and Temperature

STS 2302S

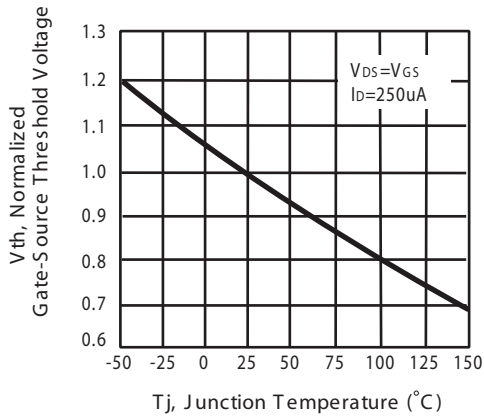

Figure 5. Gate Threshold Variation with Temperature

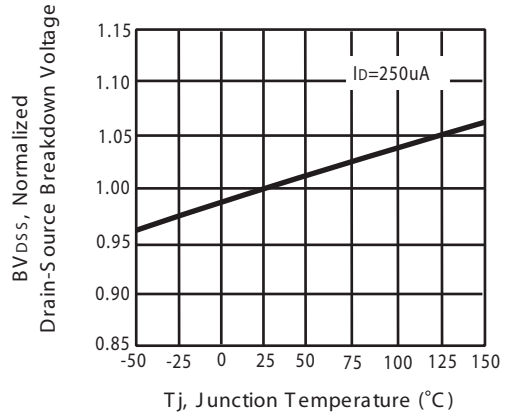

Figure 6. Breakdown Voltage Variation with Temperature

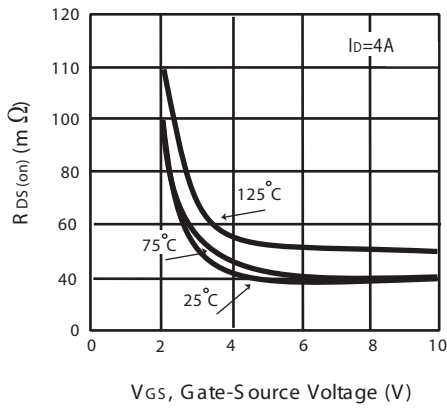

Figure 7. On-Resistance vs. Gate-Source Voltage

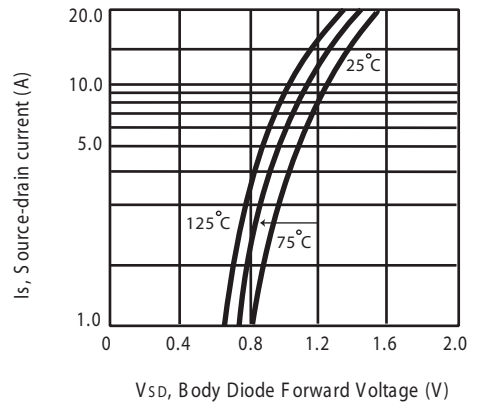

Figure 8. Body Diode Forward Voltage Variation with Source Current

STS 2302S

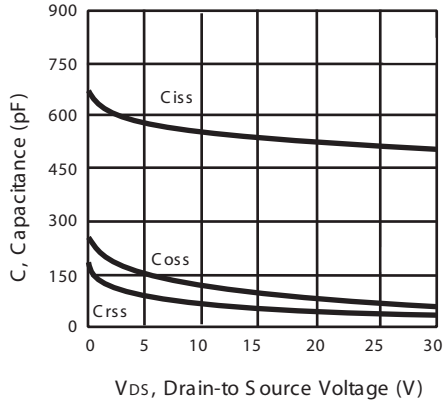

Figure 9. Capacitance

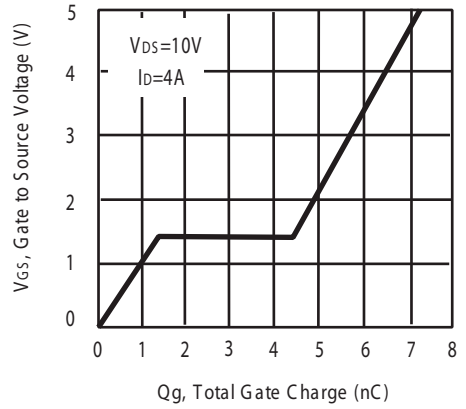

Figure 10. Gate Charge

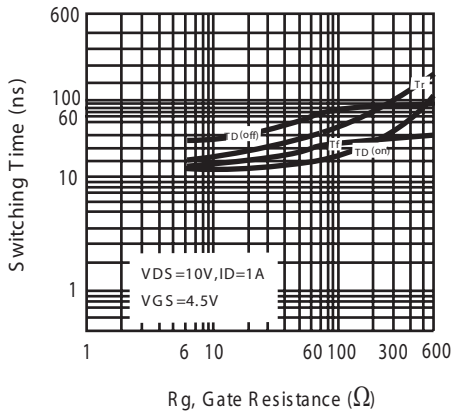

Figure 11. switching characteristics

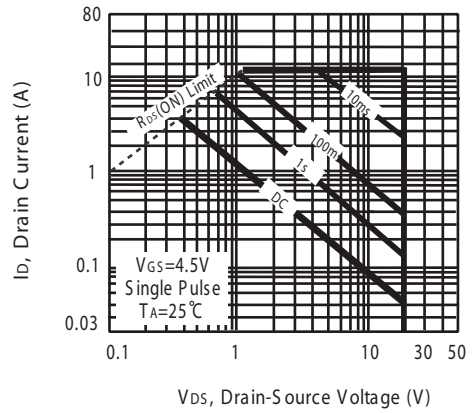

Figure 12. Maximum Safe Operating Area

STS 2302S

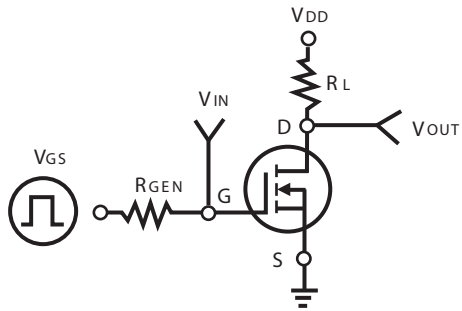

Figure 11. Switching Test Circuit

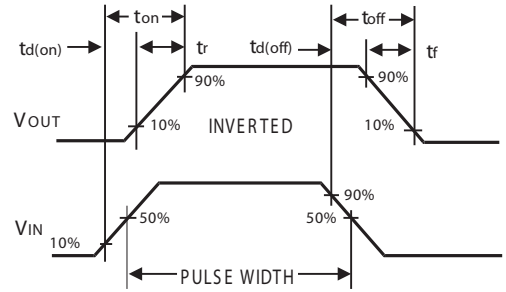
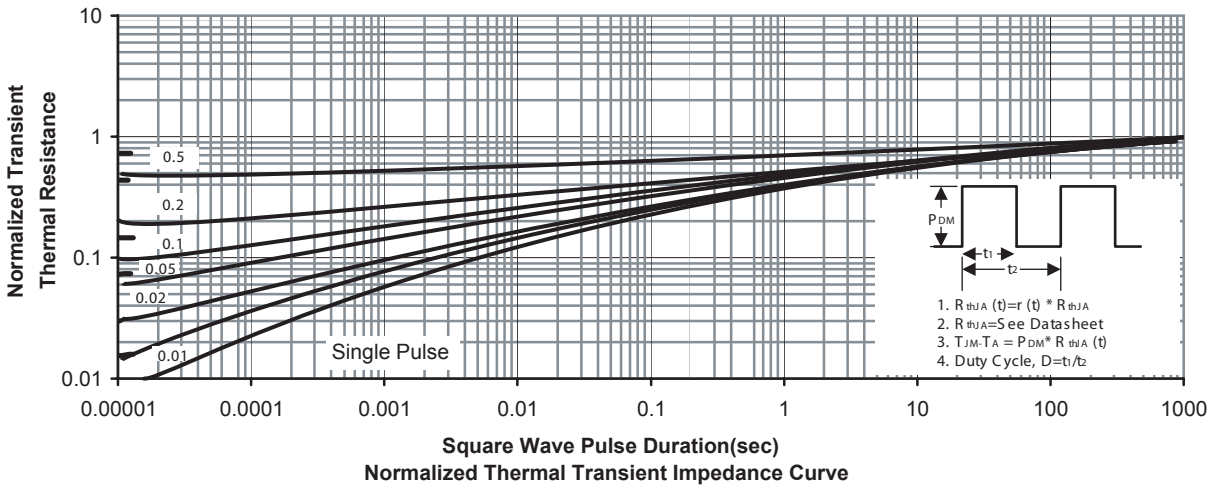

Figure 12. Switching Waveforms



STS 2302S

PACKAGE OUTLINE DIMENSIONS

SOT-23

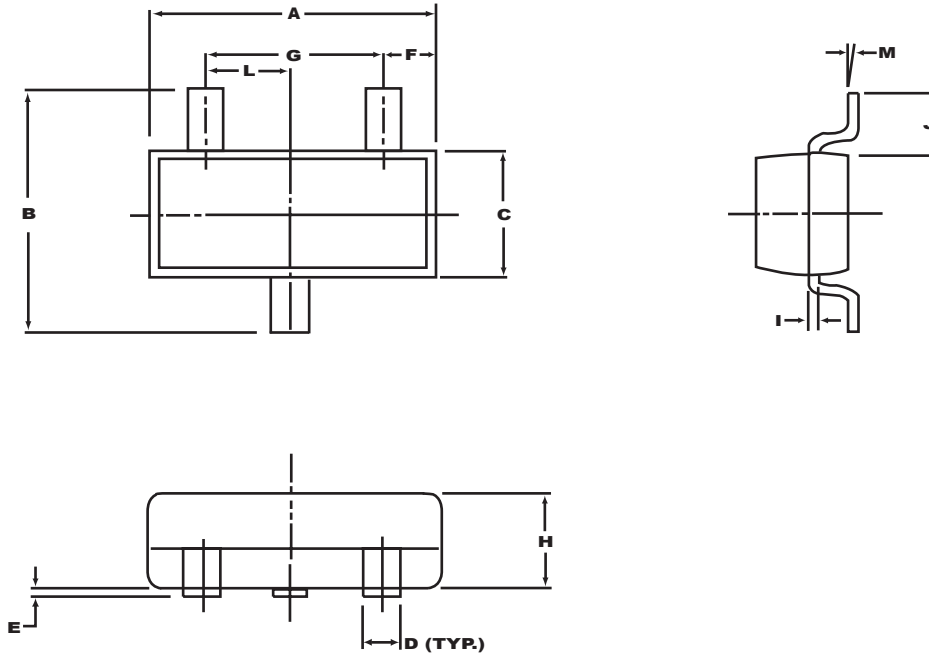

SYMBOLS	MILLIMETERS		INCHES	
	MIN	MAX	MIN	MAX
A	2.70	3.10	0.106	0.122
B	2.40	2.80	0.094	0.110
C	1.40	1.60	0.055	0.063
D	0.35	0.50	0.014	0.020
E	0	0.10	0	0.004
F	0.45	0.55	0.018	0.022
G	1.90 REF.		0.075 REF.	
H	1.00	1.30	0.039	0.051
I	0.10	0.20	0.004	0.008
J	0.40	-	0.016	-
L	0.45	1.15	0.033	0.045
M	0°	10°	0°	10°

STS 2302S

SOT-23 Tape and Reel Data

SOT-23 Carrier Tape

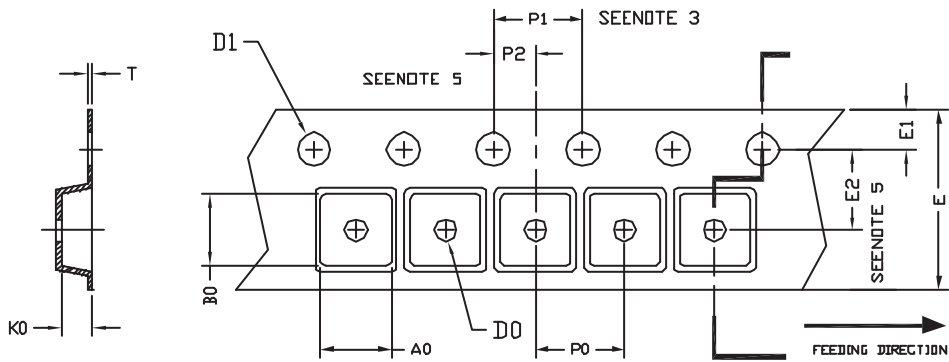

UNIT:mm

PACKAGE	A0	B0	K0	D0	D1	E	E1	E2	P0	P1	P2	T
SOT-23	3.20 ± 0.10	3.00 ± 0.10	1.33 ± 0.10	\varnothing 1.00 $+0.25$	\varnothing 1.50 $+0.10$	8.00 $+0.30$ -0.10	1.75 ± 0.10	3.50 ± 0.05	4.00 ± 0.10	4.00 ± 0.10	2.00 ± 0.05	0.20 ± 0.02

SOT-23 Reel

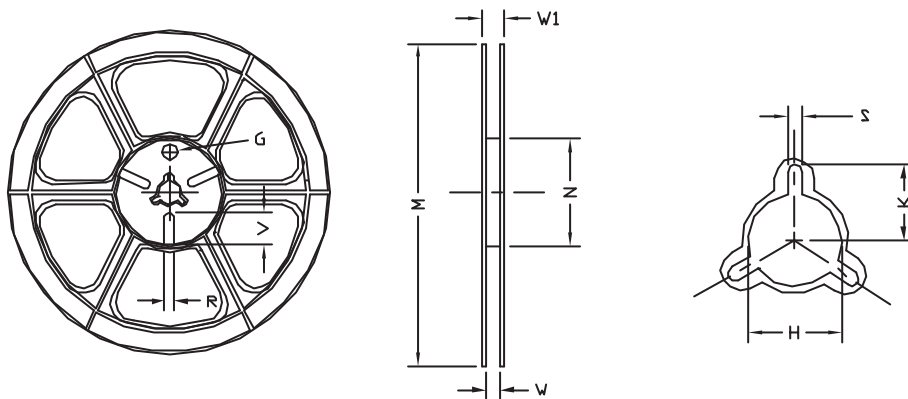

UNIT:mm

TAPE SIZE	REEL SIZE	M	N	W	W1	H	K	S	G	R	V
8mm	\varnothing 178	\varnothing 178 ± 1	\varnothing 60 ± 1	9.00 ± 0.5	12.00 ± 0.5	\varnothing 13.5 ± 0.5	10.5	2.00 ± 0.5	\varnothing 10.0	5.00	18.00