

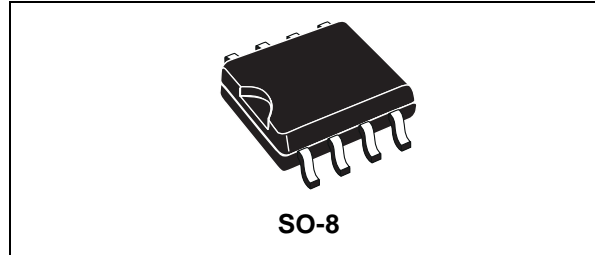

STS4DPFS2LS

P-CHANNEL 20V - 0.06Ω - 4A SO-8 STripFET™ MOSFET PLUS SCHOTTKY RECTIFIER

MAIN PRODUCT CHARACTERISTICS			
MOSFET	V_{DSS}	R_{DS(on)}	I_D
	20 V	< 0.07 Ω	4 A
SCHOTTKY	I_{F(AV)}	V_{RRM}	V_{F(MAX)}
	3 A	40 V	0.44 V



DESCRIPTION

This product associates the latest low voltage STripFET™ in p-channel version to a low drop Schottky diode. Such configuration is extremely versatile in implementing, a large variety of DC-DC converters for printers, portable equipment, and cellular phones.

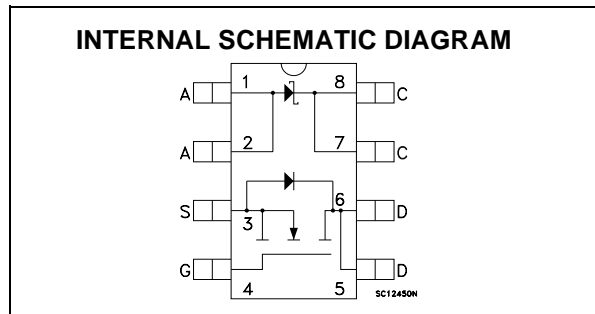

MOSFET ABSOLUTE MAXIMUM RATINGS

Symbol	Parameter	Value	Unit
V _{DS}	Drain-source Voltage (V _{GS} = 0)	20	V
V _{DGR}	Drain-gate Voltage (R _{GS} = 20 kΩ)	20	V
V _{GS}	Gate- source Voltage	± 20	V
I _D	Drain Current (continuous) at T _C = 25°C	4	A
I _D	Drain Current (continuous) at T _C = 100°C	3.4	A
I _{DM} (●)	Drain Current (pulsed)	16	A
P _{TOT}	Total Dissipation at T _C = 25°C	2	W
E _{AS} (1)	Single Pulse Avalanche Energy	20	mJ

SCHOTTKY ABSOLUTE MAXIMUM RATINGS

Symbol	Parameter	Value	Unit
V _{RRM}	Repetitive Peak Reverse Voltage	40	V
I _{F(RMS)}	RMS Forward Current	10	A
I _{F(AV)}	Average Forward Current	3	A
I _{FSM}	Surge Non Repetitive Forward Current	75	A
I _{RRM}	Repetitive Peak Reverse Current	1	A
dv/dt	Critical Rate Of Rise Of Reverse Voltage	10000	V/μs

(*) Pulse width limited by safe operating area
 (1) Starting T_j = 25°C, I_D = 2.5 A, V_{DD} = 20 V

Note: For the P-CHANNEL MOSFET actual polarity of Voltages and current has to be reversed

STS4DPFS2LS

THERMAL DATA

Rthj-amb	(*)Thermal Resistance Junction-ambient MOSFET	62.5	°C/W
Rthj-amb	(*)Thermal Resistance Junction-ambient SCHOTTKY	100	°C/W
T _{stg}	Storage Temperature Range	-55 to 150	°C
T _J	Junction Temperature	150	°C
(*) Mounted on FR-4 board (Steady State)			

MOSFET ELECTRICAL CHARACTERISTICS (TCASE = 25 °C UNLESS OTHERWISE SPECIFIED) OFF

Symbol	Parameter	Test Conditions	Min.	Typ.	Max.	Unit
V _{(BR)DSS}	Drain-source Breakdown Voltage	I _D = 250 μA, V _{GS} = 0	20			V
I _{DSS}	Zero Gate Voltage Drain Current (V _{GS} = 0)	V _{DS} = Max Rating V _{DS} = Max Rating, T _C = 125 °C			1 10	μA μA
I _{GSS}	Gate-body Leakage Current (V _{DS} = 0)	V _{GS} = ± 20 V			±100	nA

ON (1)

Symbol	Parameter	Test Conditions	Min.	Typ.	Max.	Unit
V _{GS(th)}	Gate Threshold Voltage	V _{DS} = V _{GS} , I _D = 250μA	1	1.6	2.5	V
R _{DS(on)}	Static Drain-source On Resistance	V _{GS} = 10V, I _D = 2.5 A V _{GS} = 4.5V, I _D = 2.5 A		0.06 0.07	0.07 0.085	Ω
I _{D(on)}	On State Drain Current	V _{DS} > I _{D(on)} × R _{DS(on)max} , V _{GS} = 10V	16			A

DYNAMIC

Symbol	Parameter	Test Conditions	Min.	Typ.	Max.	Unit
g _{fs} (1)	Forward Transconductance	V _{DS} > I _{D(on)} × R _{DS(on)max} , I _D = 2 A		5		S
C _{iss}	Input Capacitance	V _{DS} = 25V, f = 1 MHz, V _{GS} = 0		1350		pF
C _{oss}	Output Capacitance			490		pF
C _{rss}	Reverse Transfer Capacitance			130		pF

ELECTRICAL CHARACTERISTICS (CONTINUED)

SWITCHING ON

Symbol	Parameter	Test Conditions	Min.	Typ.	Max.	Unit
$t_{d(on)}$	Turn-on Delay Time	$V_{DD} = 15V, I_D = 3A, R_G = 4.7\Omega$ $V_{GS} = 10V$ (see test circuit, Figure 3)		25		ns
t_r	Rise Time			35		ns
Q_g	Total Gate Charge	$V_{DD} = 24V, I_D = 6A,$ $V_{GS} = 4.5 V$		12.5	16	nC
Q_{gs}	Gate-Source Charge			5		nC
Q_{gd}	Gate-Drain Charge			3		nC

SWITCHING OFF

Symbol	Parameter	Test Conditions	Min.	Typ.	Max.	Unit
$t_{d(off)}$	Turn-off Delay Time	$V_{DD} = 15 V, I_D = 2A,$ $R_G = 4.7\Omega, V_{GS} = 4.5 V$ (see test circuit, Figure 3)		125		ns
t_f	Fall Time			30		ns
$t_r(V_{off})$	Off-voltage Rise Time	$V_{clamp} = 24 V, I_D = 6 A,$ $R_G = 4.7\Omega, V_{GS} = 4.5 V$ (see test circuit, Figure 5)		83		ns
t_f	Fall Time			40		ns
t_c	Cross-over Time			75		ns

SOURCE DRAIN DIODE

Symbol	Parameter	Test Conditions	Min.	Typ.	Max.	Unit
I_{SD}	Source-drain Current				4	A
$I_{SDM(2)}$	Source-drain Current (pulsed)				16	A
$V_{SD(1)}$	Forward On Voltage	$I_{SD} = 4 A, V_{GS} = 0$			1.2	V
t_{rr}	Reverse Recovery Time	$I_{SD} = 4 A, di/dt = 100A/\mu s,$ $V_{DD} = 15 V, T_J = 150^\circ C$ (see test circuit, Figure 5)		45		ns
Q_{rr}	Reverse Recovery Charge			36		nC
I_{RRM}	Reverse Recovery Current			1.6		A

Note: 1. Pulsed: Pulse duration = 300 μs , duty cycle 1.5 %.
2. Pulse width limited by safe operating area.

SCHOTTCKY STATIC ELECTRICAL CHARACTERISTICS

Symbol	Parameter	Test Conditions	Min.	Typ.	Max.	Unit
$I_R(^*)$	Reversed Leakage Current	$T_J = 25^\circ C, V_R = 30 V$ $T_J = 125^\circ C, V_R = 30 V$		14 8	50 18	μA mA
$V_F(^*)$	Forward Voltage Drop	$T_J = 25^\circ C, I_F = 1 A$ $T_J = 125^\circ C, I_F = 1 A$ $T_J = 25^\circ C, I_F = 2 A$ $T_J = 125^\circ C, I_F = 2 A$ $T_J = 25^\circ C, I_F = 3 A$ $T_J = 125^\circ C, I_F = 3 A$		0.37 0.28 0.41 0.34 0.4	0.42 0.32 0.46 0.39 0.5 0.44	V V V V V V

STS4DPFS2LS

Safe Operating Area

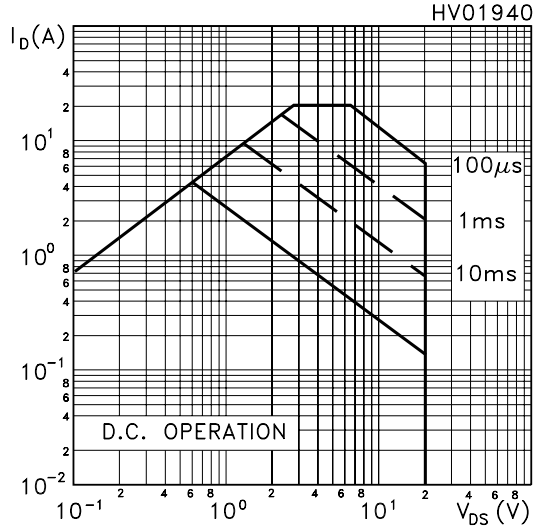

Thermal Impedance

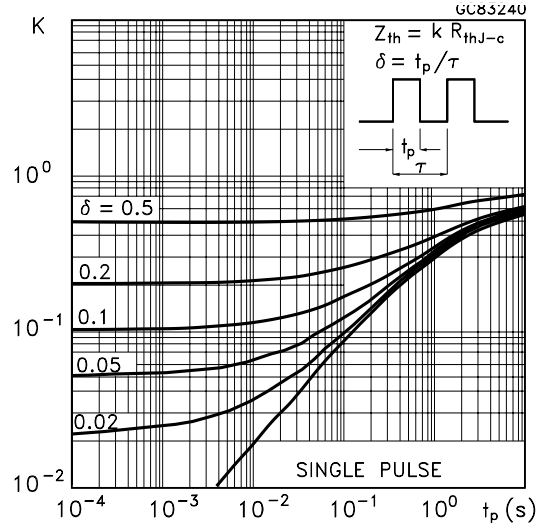

Output Characteristics

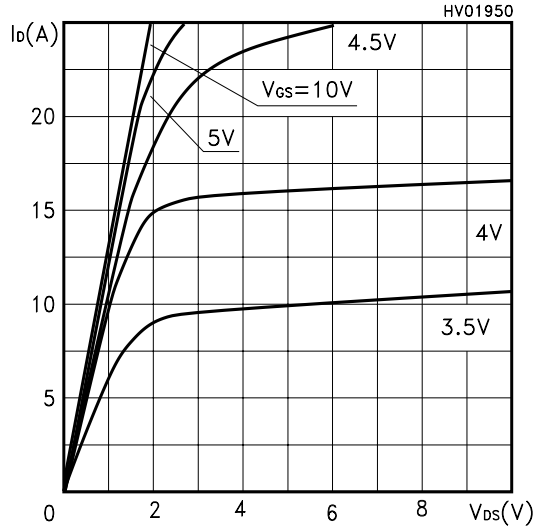

Transfer Characteristics

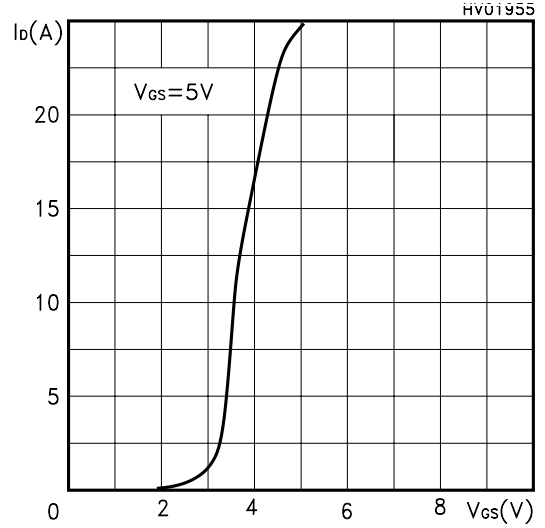

Transconductance

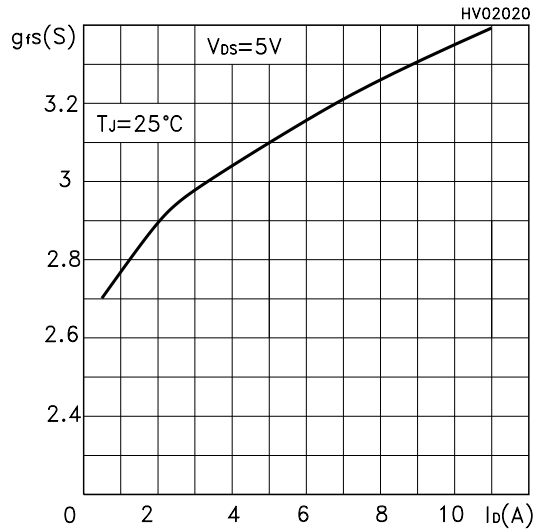

Static Drain-source On Resistance

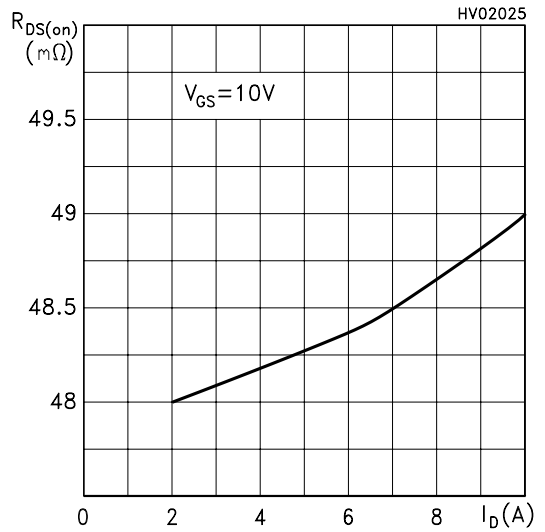

Gate Charge vs Gate-source Voltage

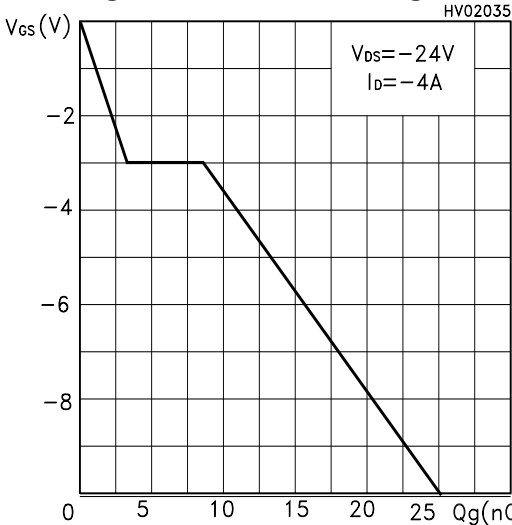

Capacitance Variations

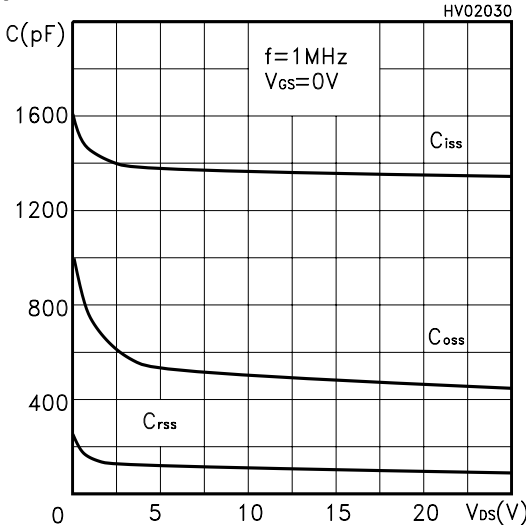

Normalized Gate Threshold Voltage vs Temp.

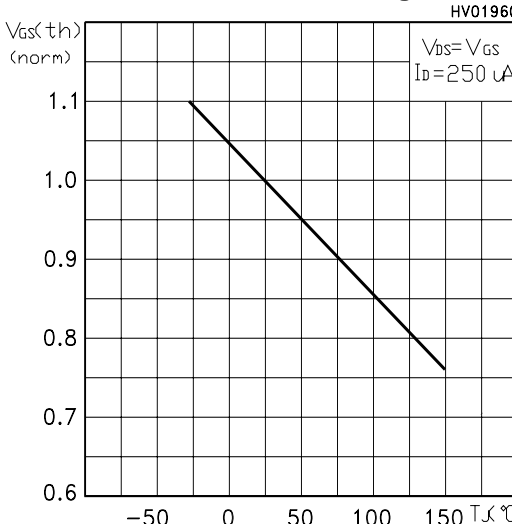

Normalized On Resistance vs Temperature

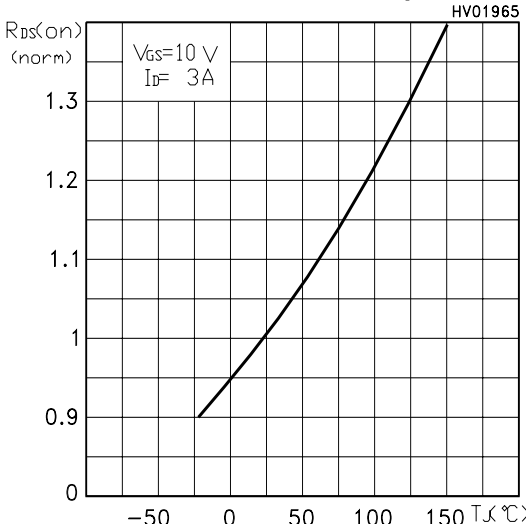

Source-drain Diode Forward Characteristics

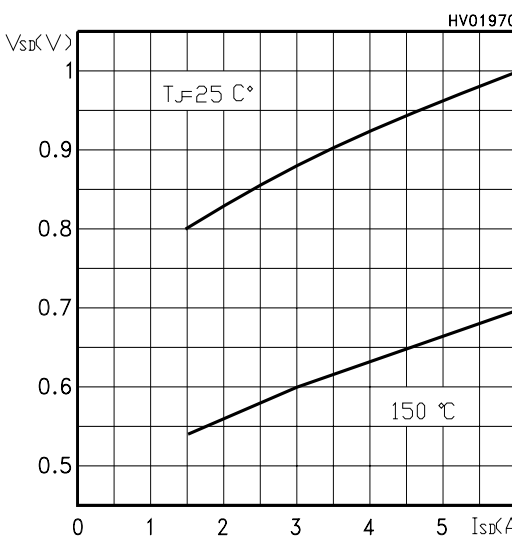

Fig. 1: Unclamped Inductive Load Test Circuit



Fig. 2: Unclamped Inductive Waveform



Fig. 3: Switching Times Test Circuits For Resistive Load



Fig. 4: Gate Charge test Circuit

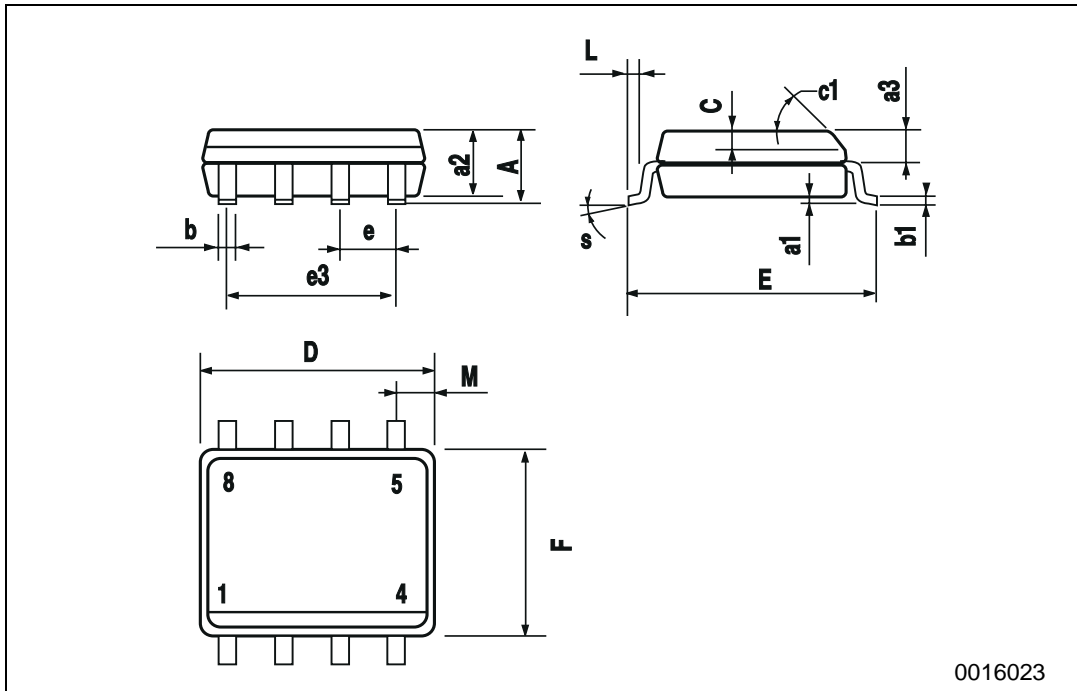

Fig. 5: Test Circuit For Inductive Load Switching And Diode Recovery Times



SO-8 MECHANICAL DATA

DIM.	mm			inch		
	MIN.	TYP.	MAX.	MIN.	TYP.	MAX.
A			1.75			0.068
a1	0.1		0.25	0.003		0.009
a2			1.65			0.064
a3	0.65		0.85	0.025		0.033
b	0.35		0.48	0.013		0.018
b1	0.19		0.25	0.007		0.010
C	0.25		0.5	0.010		0.019
c1	45 (typ.)					
D	4.8		5.0	0.188		0.196
E	5.8		6.2	0.228		0.244
e		1.27			0.050	
e3		3.81			0.150	
F	3.8		4.0	0.14		0.157
L	0.4		1.27	0.015		0.050
M			0.6			0.023
S	8 (max.)					



Information furnished is believed to be accurate and reliable. However, STMicroelectronics assumes no responsibility for the consequences of use of such information nor for any infringement of patents or other rights of third parties which may result from its use. No license is granted by implication or otherwise under any patent or patent rights of STMicroelectronics. Specification mentioned in this publication are subject to change without notice. This publication supersedes and replaces all information previously supplied. STMicroelectronics products are not authorized for use as critical components in life support devices or systems without express written approval of STMicroelectronics.

The ST logo is a trademark of STMicroelectronics

© 2000 STMicroelectronics – Printed in Italy – All Rights Reserved
STMicroelectronics GROUP OF COMPANIES

Australia - Brazil - China - Finland - France - Germany - Hong Kong - India - Italy - Japan - Malaysia - Malta - Morocco -
Singapore - Spain - Sweden - Switzerland - United Kingdom - U.S.A.

<http://www.st.com>