

Features

- Typical Isolation: 35 dB (2.0 GHz)
- Typical Insertion Loss: 1.2 dB (2.0 GHz)
- Integral ASIC/CMOS Driver
- 50 Ohm Nominal Impedance
- Low DC Power Consumption
- Test Boards Available

Description

M/A-COM's SW65-0440 is a GaAs MMIC absorptive SP4T switch with an integral silicon ASIC driver. This device is in a 24-lead plastic package. This switch offers excellent broadband performance and repeatability from DC to 3 GHz, while maintaining low DC power dissipation. The SW65-0440 is ideally suited for wireless infrastructure applications.

QSOP-24

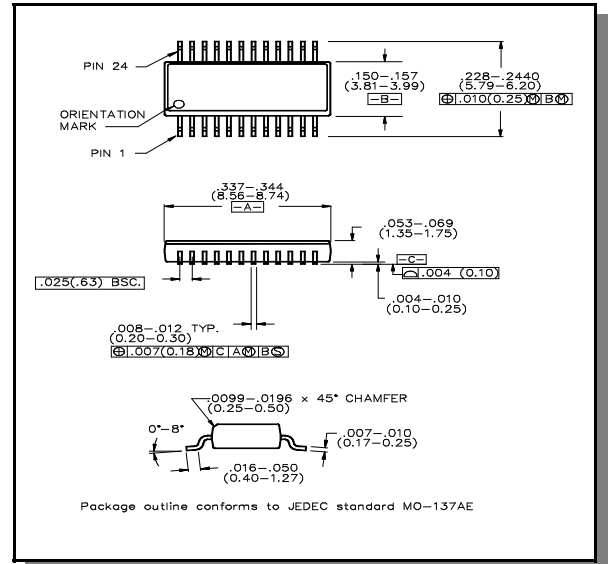

Electrical Specifications: $T_A = 25^\circ\text{C}$

Parameter	Test Conditions	Units	Min.	Typ.	Max.
Insertion Loss	DC - 2.0 GHz	dB	—	1.2	1.8
	DC - 3.0 GHz	dB	—	1.3	2.5
Isolation (All arms off)	DC - 2.0 GHz	dB	32	35	—
	DC - 3.0 GHz	dB	25	29	—
VSWR	RF1-RF4 On	Ratio	—	1.2:1	1.6:1
	RF1- RF4 Off	Ratio	—	1.4:1	1.8:1
	RFC	Ratio	—	1.2:1	1.5:1
	RFC	Ratio	—	1.6:1	2.2:1
Switching Speed ¹	T_{rise} T_{fall}	nS	-	15	50
	T_{on} T_{off}	nS	-	50	150
	Transients	mV	-	50	150
1 dB Compression	.05 GHz	dBm	-	+20	-
	.5 - 3.0 GHz	dBm	-	+27	-
Input IP_3	Two tone inputs 0.05 GHz	dBm	-	+35	-
	up to +5 dBm 0.5 - 3.0 GHz	dBm	-	+46	-
V_{CC}	-	V	+4.5	+5.0	+5.5
V_{EE}	-	V	-8.0	-5.0	-4.75
I_{CC}	$V_{CC} = +5.0\text{V}$	mA	-	-	4
I_{EE}	$V_{EE} = -5.0\text{V}$	mA	-	-	-1
Logic "0"	$I_{\text{in}} = 20\mu\text{A max}$	V	0.0	-	0.8
Logic "1"	$I_{\text{in}} = 20\mu\text{A max}$	V	2.0	-	5.0

1. Decoupling capacitors (.01 μF) are required on the power supply lines.

Recommended PCB Layout—SP4T

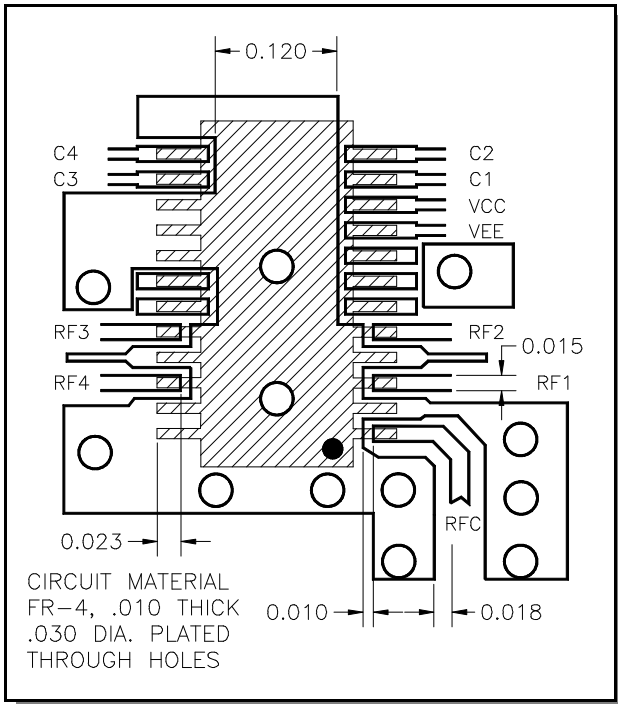

Recommended PCB Layout—SP2T

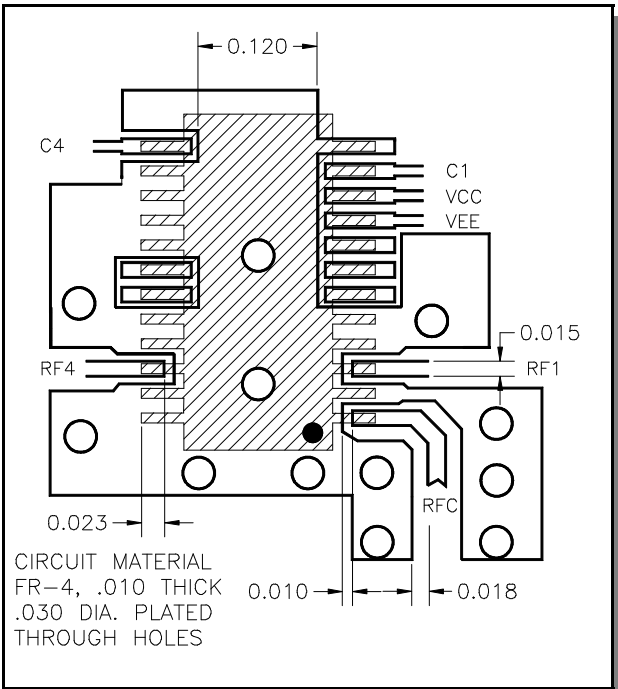

Pin Configuration

Pin No.	Function	Pin No.	Function
1	RFC	13	C4
2	GND	14	C3
3	RF1	15	GND
4	GND	16	GND
5	RF2	17	GND
6	N/C	18	N/C
7	N/C	19	N/C
8	N/C	20	RF3
9	V _{EE}	21	GND
10	V _{CC}	22	RF4
11	C1	23	GND
12	C2	24	GND

N/C = No Connection

Absolute Maximum Ratings^{2,3}

Parameter	Absolute Maximum
Max. Input Power 0.05 GHz 0.5 - 4.0 GHz	+27 dBm +34 dBm
Bias Voltages V _{EE} V _{CC} Control Voltage ⁴	-8.5V +5.5V -0.5V to V _{CC} +0.5V
Storage Temperature	-65°C to +125°C
Operating Temperature	-40°C to +85°C

2. Operation of this device above any one of these parameters may cause permanent damage.
3. When the RF input is applied to the terminated port, the absolute maximum power is +30 dBm.
4. Standard CMOS TTL interface, latch-up will occur if logic signal is applied prior to power supply.

Truth Table

TTL				RF Common To:			
C1	C2	C3	C4	RF1	RF2	RF3	RF4
1	0	0	0	On	Off	Off	Off
0	1	0	0	Off	On	Off	Off
0	0	1	0	Off	Off	On	Off
0	0	0	1	Off	Off	Off	On

Specifications subject to change without notice.

- North America: Tel. (800) 366-2266
- Asia/Pacific: Tel.+81-44-844-8296, Fax +81-44-844-8298
- Europe: Tel. +44 (1344) 869 595, Fax+44 (1344) 300 020

Visit www.macom.com for additional data sheets and product information.

Typical Performance Curves

Insertion Loss (dB) @ +25°C

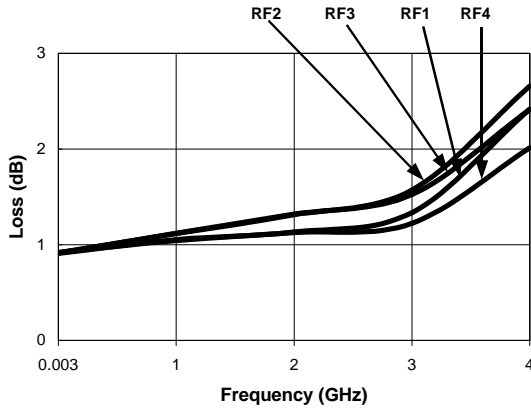

Loss Variation Over Temp. (dB)

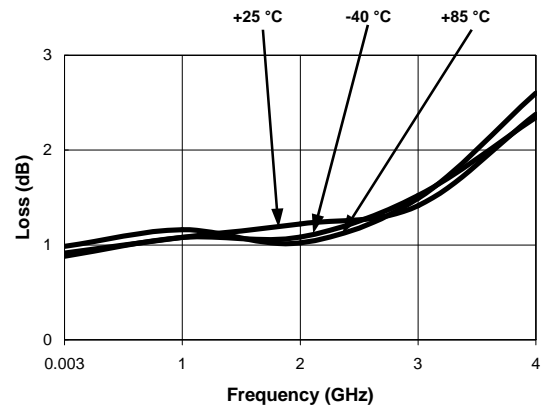

RF1 - RF4 On VSWR @ +25°C

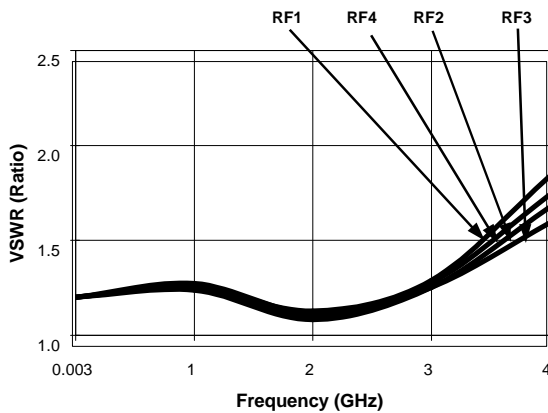

RF1 - RF4 On VSWR Temp. Variation

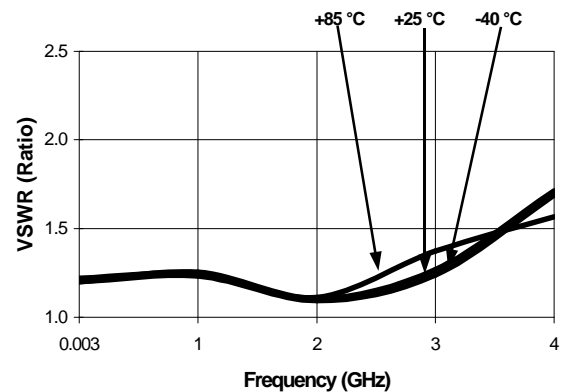

RFC On VSWR @ +25°C

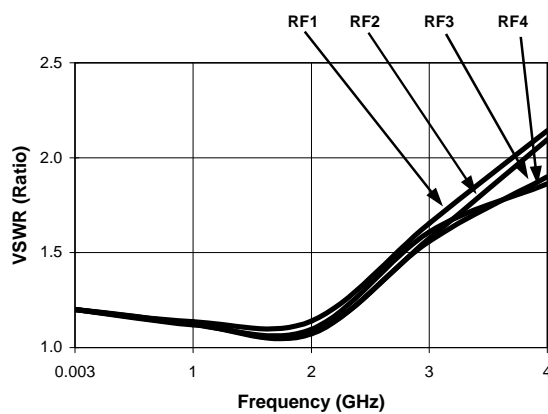

RFC On VSWR Temp. Variation

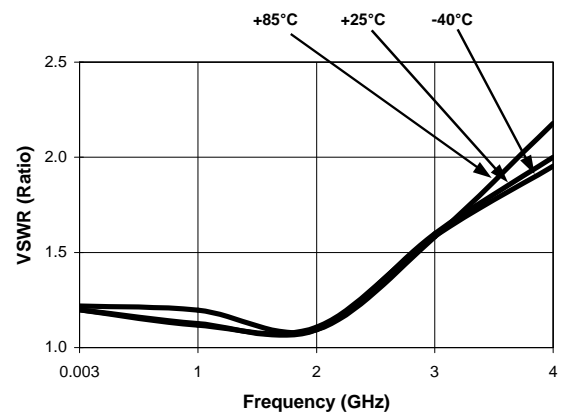

Specifications subject to change without notice.

- North America: Tel. (800) 366-2266
- Asia/Pacific: Tel.+81-44-844-8296, Fax +81-44-844-8298
- Europe: Tel. +44 (1344) 869 595, Fax+44 (1344) 300 020

Visit www.macom.com for additional data sheets and product information.

Typical Performance Curves

RF1 - RF4 Off VSWR @ +25°C

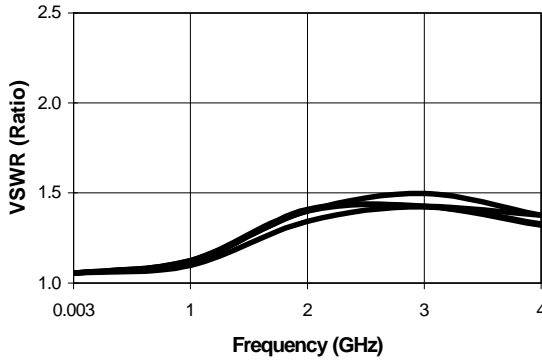

RF1 - RF4 Off VSWR Temp. Variation

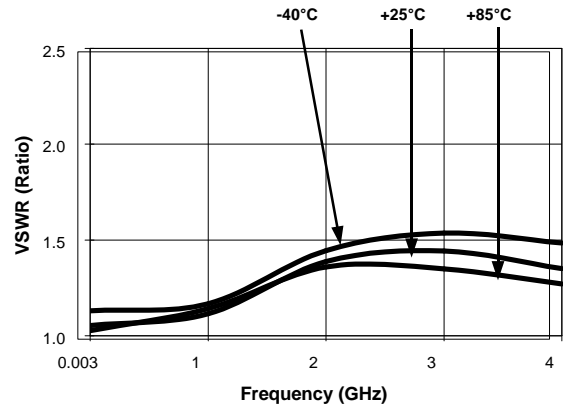

Isolation (dB) @ +25°C

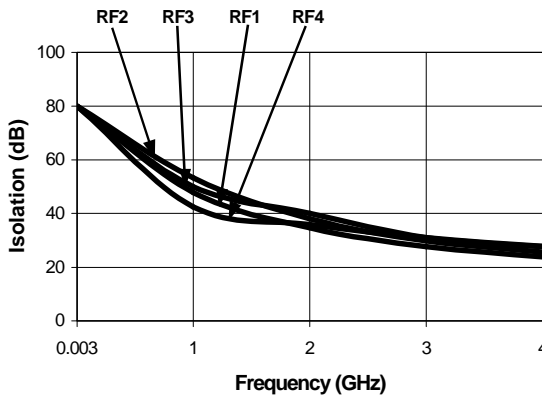

Isolation Temp. Variation (dB)

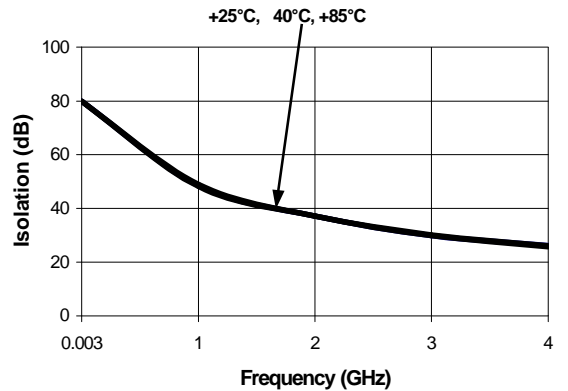

Evaluation Board
P/N SW65-0440-TB

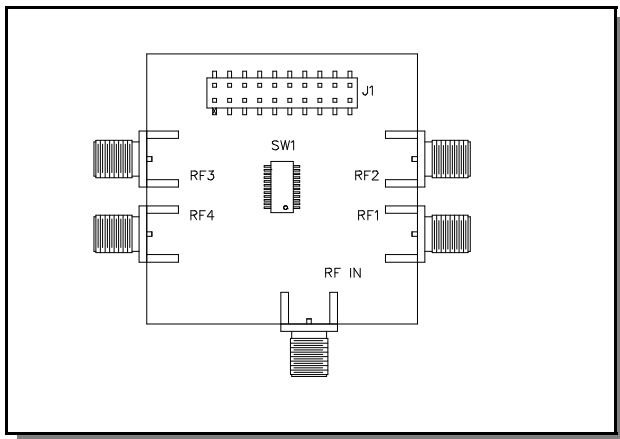

Ordering Information

Part Number	Package
SW65-0440	Bulk Packaging
SW65-0440TR	Tape and Reel (1K Reel)
SW65-0440-TB	Unit Mounted on Test Board

Specifications subject to change without notice.

- North America: Tel. (800) 366-2266
- Asia/Pacific: Tel.+81-44-844-8296, Fax +81-44-844-8298
- Europe: Tel. +44 (1344) 869 595, Fax+44 (1344) 300 020

Visit www.macom.com for additional data sheets and product information.