

P-Channel 12-V (D-S) MOSFET

PRODUCT SUMMARY		
V_{DS} (V)	$r_{DS(on)}$ (Ω)	I_D (A)
-12	0.016 @ $V_{GS} = -4.5$ V	-13
	0.022 @ $V_{GS} = -2.5$ V	-11
	0.028 @ $V_{GS} = -1.8$ V	-9.8

FEATURES

- TrenchFET® Power MOSFETS: 1.8-V Rated
- New PowerPAK® Package
 - Low Thermal Resistance, R_{thJC}
 - Low 1.07-mm Profile

APPLICATIONS

- Load Switch
- Power Switch
- PA Switch

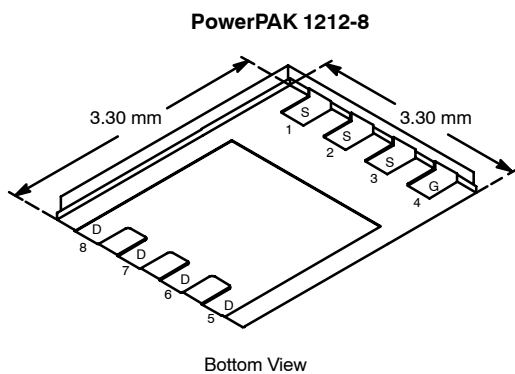

Ordering Information: Si7405DN-T1

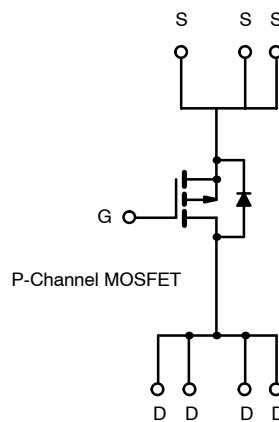

ABSOLUTE MAXIMUM RATINGS ($T_A = 25^\circ\text{C}$ UNLESS OTHERWISE NOTED)				
Parameter	Symbol	10 secs	Steady State	Unit
Drain-Source Voltage	V_{DS}	-12		V
Gate-Source Voltage	V_{GS}	± 8		
Continuous Drain Current ($T_J = 150^\circ\text{C}$) ^a	I_D	$T_A = 25^\circ\text{C}$	-13	-8.3
		$T_A = 85^\circ\text{C}$	-9.4	-6.0
Pulsed Drain Current	I_{DM}	-30		A
continuous Source Current (Diode Conduction) ^a	I_S	-3.2	-1.3	
Maximum Power Dissipation ^a	P_D	$T_A = 25^\circ\text{C}$	3.8	1.5
		$T_A = 85^\circ\text{C}$	2.0	0.8
Operating Junction and Storage Temperature Range	T_J, T_{stg}	-55 to 150		$^\circ\text{C}$

THERMAL RESISTANCE RATINGS				
Parameter	Symbol	Typical	Maximum	Unit
Maximum Junction-to-Ambient ^a	R_{thJA}	$t \leq 10$ sec	26	33
		Steady State	65	81
Maximum Junction-to-Case	R_{thJC}	1.9	2.4	$^\circ\text{C/W}$

Notes

a. Surface Mounted on 1" x 1" FR4 Board.



SPECIFICATIONS (T _J = 25 °C UNLESS OTHERWISE NOTED)						
Parameter	Symbol	Test Condition	Min	Typ	Max	Unit
Static						
Gate Threshold Voltage	V _{GS(th)}	V _{DS} = V _{GS} , I _D = -2 mA	-0.45			V
Gate-Body Leakage	I _{GSS}	V _{DS} = 0 V, V _{GS} = ±8 V			±100	nA
Zero Gate Voltage Drain Current	I _{DSS}	V _{DS} = -12 V, V _{GS} = 0 V			-1	μA
		V _{DS} = -12 V, V _{GS} = 0 V, T _J = 85 °C			-5	
On-State Drain Current ^a	I _{D(on)}	V _{DS} ≤ -5 V, V _{GS} = -4.5 V	-30			A
Drain-Source On-State Resistance ^a	r _{DS(on)}	V _{GS} = -4.5 V, I _D = -13 A		0.013	0.016	Ω
		V _{GS} = -2.5 V, I _D = -11 A		0.018	0.022	
		V _{GS} = -1.8 V, I _D = -3 A		0.022	0.028	
Forward Transconductance ^a	g _{fs}	V _{DS} = -6 V, I _D = -13 A		35		S
Diode Forward Voltage ^a	V _{SD}	I _S = -3.2 A, V _{GS} = 0 V		-0.7	-1.2	V
Dynamic^b						
Total Gate Charge	Q _g	V _{DS} = -6 V, V _{GS} = -4.5 V, I _D = -13 A		35	50	nC
Gate-Source Charge	Q _{gs}			6.6		
Gate-Drain Charge	Q _{gd}			7.7		
Turn-On Delay Time	t _{d(on)}	V _{DD} = -6 V, R _L = 6 Ω I _D ≅ -1 A, V _{GEN} = -4.5 V, R _G = 6 Ω		25	40	ns
Rise Time	t _r			50	75	
Turn-Off Delay Time	t _{d(off)}			175	260	
Fall Time	t _f			150	225	
Source-Drain Reverse Recovery Time	t _{rr}		I _F = -3.2 A, di/dt = 100 A/μs		30	

Notes

- a. Pulse test; pulse width ≤ 300 μs, duty cycle ≤ 2%.
- b. Guaranteed by design, not subject to production testing.

TYPICAL CHARACTERISTICS (25 °C UNLESS NOTED)

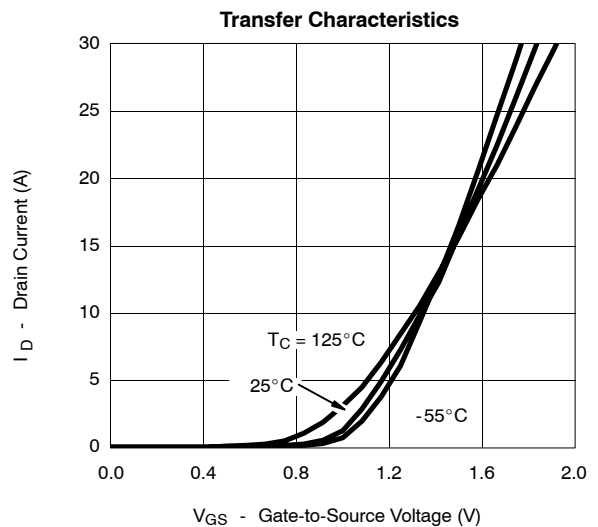
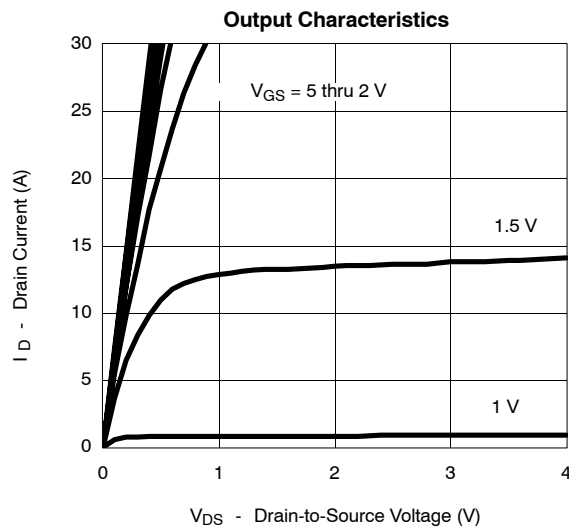

TYPICAL CHARACTERISTICS (25 °C UNLESS NOTED)

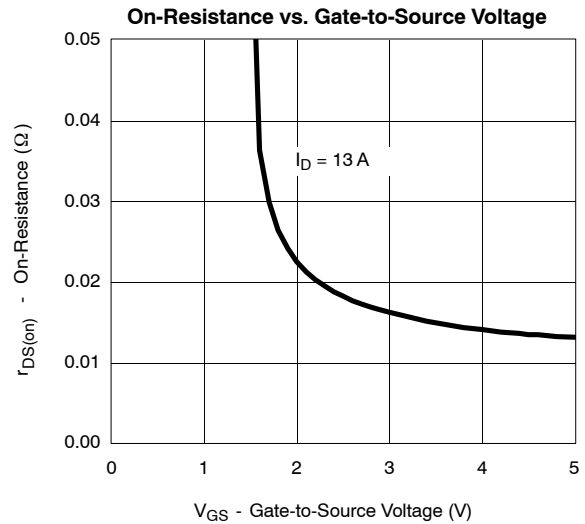
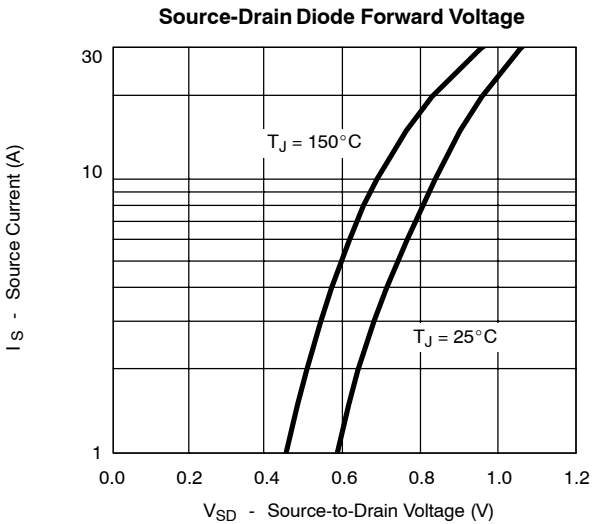
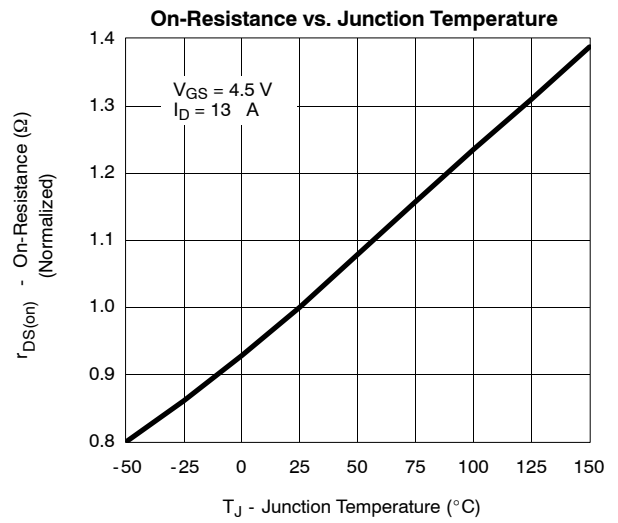
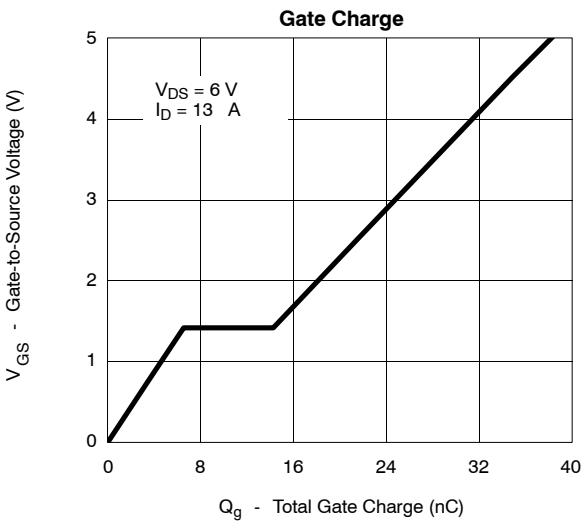
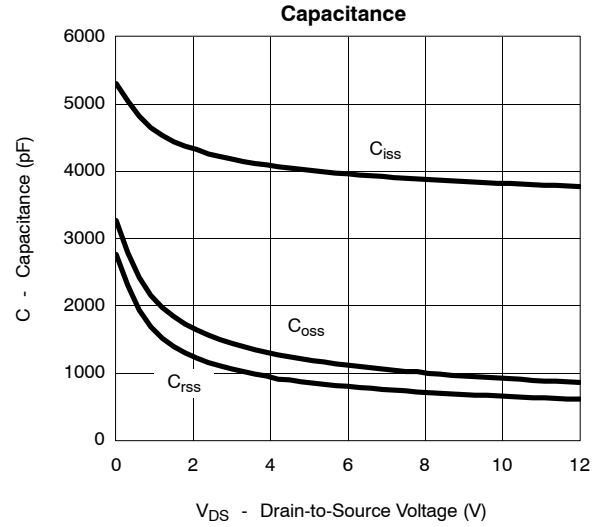
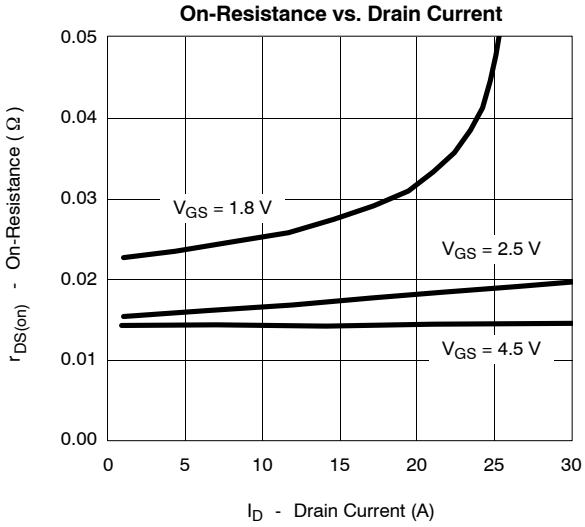

TYPICAL CHARACTERISTICS (25 °C UNLESS NOTED)

