

Table 1-1. Functional Block Description

Name	Description
AUX REG	Auxiliary voltage regulator
BBF	Baseband filter
CP	Charge pump
DAC	D/A converter for demodulator tuning
DEMODO	Demodulator
GF	Gaussian filter for transmit data
IF AMP1	1st intermediate frequency amplifier
IF AMP2	2nd intermediate frequency amplifier
IR MIXER	Image rejection mixer
PC	Programmable counter
PD	Phase detector
RAMP GEN	Ramp-signal generator
RC	Reference counter
RSSI	Received signal-strength indicator
TX DRIVER	Buffer amplifier for TX_OUT
TX/RX SWITCH	Switches VCO signal to IR MIXER respectively TX DRIVER
VCO	Voltage-controlled oscillator
VCO REG	Voltage regulator for VCO

2. Pin Configuration

Figure 2-1. Pinning QFN48

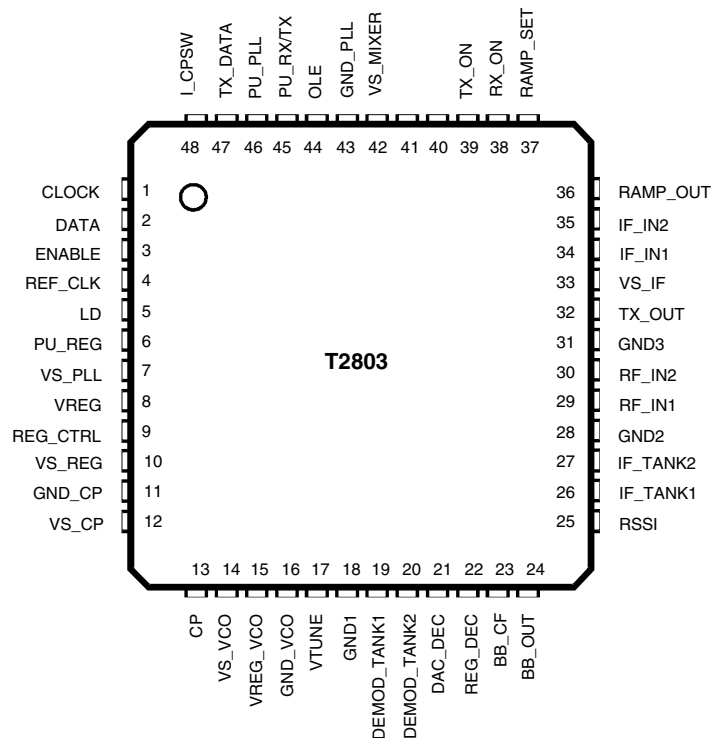

Table 2-1. Pin Description

Pin	Symbol	Function	Configuration
1 2 3	CLOCK DATA ENABLE	3-wire-bus: Clock input 3-wire-bus: Data input 3-wire-bus: Enable input	
4	REF_CLK	Reference-frequency input	
5	LD	Lock-detect output	
6	PU_REG	Power-up input for auxiliary voltage regulator	

Table 2-1. Pin Description (Continued)

Pin	Symbol	Function	Configuration
7	VS_PLL	PLL supply voltage	
8	VREG	Auxiliary voltage-regulator output	
9	REG_CTRL	Auxiliary voltage-regulator control output	
10	VS_REG	Auxiliary voltage-regulator supply voltage	
11	GND_CP	Charge-pump ground	
12	VS_CP	Charge-pump supply voltage	
13	CP	Charge-pump output	

Table 2-1. Pin Description (Continued)

Pin	Symbol	Function	Configuration
14	VS_VCO	VCO voltage-regulator supply voltage	<p>VS_VCO 14 VS_PLL 7 VREG_VCO 15 GND_PLL 43 GND_VCO 16</p>
15	VREG_VCO	VCO voltage-regulator control output	
16	GND_VCO	VCO ground	
17	VTUNE	VCO tuning voltage input	<p>VREG_VCO 15 VS_PLL 7 VTUNE 17 GND_PLL 43 GND_VCO 16</p>
18	GND1	Ground	<p>VS_PLL 7 VS_REG 10 VS_CP 12 VS_VCO 14 VS_IF 33 VS_MIXER 42 GND1 18 GND2 28 GND3 31 GND_VCO 16 GND_CP 11 GND_PLL 43</p>

Table 2-1. Pin Description (Continued)

Pin	Symbol	Function	Configuration
19	DEMOTANK1	Demodulator tank circuit	
20	DEMOTANK2	Demodulator tank circuit	
21	DAC_DEC	Decoupling pin	
22	REG_DEC	Decoupling pin for VCO_REG	

Table 2-1. Pin Description (Continued)

Pin	Symbol	Function	Configuration
23	BB_CF	Baseband filter corner-frequency control input	
24	BB_OUT	Baseband filter output	
25	RSSI	Received signal strength indicator output	
26	IF_TANK1	IF tank circuit	
27	IF_TANK2	IF tank circuit	

Table 2-1. Pin Description (Continued)

Pin	Symbol	Function	Configuration
28	GND2	Ground	
29	RF_IN1	RF input of image reject mixer	
30	RF_IN2	RF input of image reject mixer	
31	GND3	Ground	

Table 2-1. Pin Description (Continued)

Pin	Symbol	Function	Configuration
32	TX_OUT	TX driver amplifier output for PA	
33	VS_IF	IF amplifier supply voltage	
34	IF_IN1	IF input of IF amplifier	
35	IF_IN2	IF input of IF amplifier	
36	RAMP_OUT	Ramp-generator output for PA power ramping	

Table 2-1. Pin Description (Continued)

Pin	Symbol	Function	Configuration
37	RAMP_SET	Slew-rate setting of ramping signal	
38	RX_ON	RX control input	
39	TX_ON	TX control input	
40	MIXER_OUT1	Mixer output to SAW filter	
41	MIXER_OUT2	Mixer output to SAW filter	

Table 2-1. Pin Description (Continued)

Pin	Symbol	Function	Configuration
42	VS_MIXER	Mixer supply voltage	
43	GND_PLL	PLL ground	
44	OLE	Open loop enable input	
45	PU_RX/TX	RX/TX power-up input	

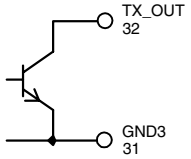
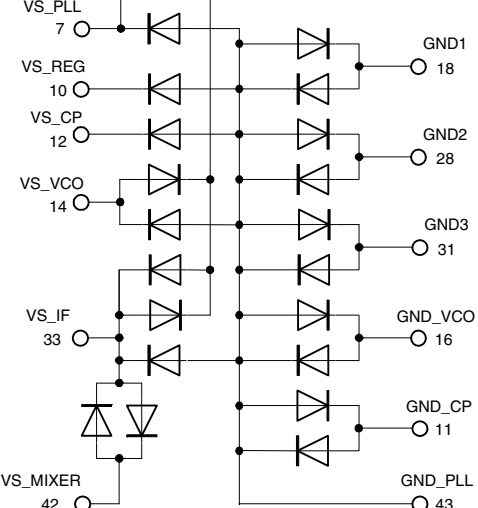
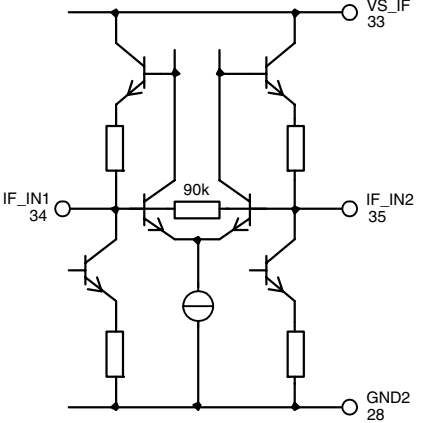
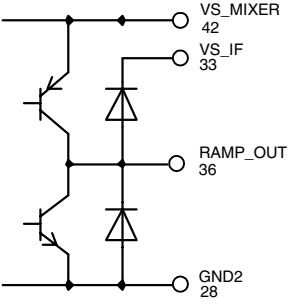
3. Functional Description

3.1 Receiver

The RF signal at RF_IN is fed to an image rejection mixer IR_MIXER with its differential outputs MIXER_OUT1 and MIXER_OUT2 driving an IF-SAW filter at 110.592 MHz or 112.32 MHz. The IF_AMP1 and IF_AMP2 IF amplifiers with an external IF_TANK and an integrated RSSI function feed the signal to the demodulator DEMOD working at $f = f_{IF}/2$ (≈ 55 MHz) and finally to an integrated baseband filter BB. For demodulator tuning in production an integrated 5-bit digital-to-analog (D/A) converter is provided to control the on-chip varicap diode.

3.2 Transmitter

The transmit data at TX_DATA is filtered by an integrated Gaussian Filter GF and fed to the fully integrated VCO operating at twice the output frequency. After modulation the signal is frequency-divided by 2 and fed via a TX/RX SWITCH to the TX_DRIVER. This bus-controlled driver amplifier supplies typically +3 dBm output power at TX_OUT. A ramp-signal generator RAMP_GEN, providing a ramp signal at RAMP_OUT for the external power amplifier, is integrated. The slope of the ramp signal is controlled by a capacitor at the RAMP_SET pin.

3.3 Synthesizer

The IR_MIXER, the TX_DRIVER and the programmable counter PC are driven by the fully integrated VCO (including on-chip inductors and varactors). The output signal is frequency-divided to supply the desired frequency to the TX_DRIVER, 0/90 degree phase shifter for the IR_MIXER and to be used by the PC for the phase detector PD ($f_{PD} = 1.728$ MHz). Open loop modulation is supported.

3.4 Power Supply

An integrated bandgap-stabilized voltage regulator for use with an external low-cost PNP transistor is implemented. Multiple power-down and current saving modes are provided.

Figure 3-1. PLL Principle



Table 3-1 shows the LO frequencies for RX and TX for the DECT band plus additional channels for the extended DECT band. Intermediate frequencies of 110.592 MHz and 112.32 MHz are supported.

Table 3-1. LO Frequencies

Mode	f_{IF} /MHz	Channel	f_{ANT} /MHz	f_{VCO} /MHz	S_{MC}	S_{SC}	N
TX	-	C0	2401.056	2401.056	86	27	2779
		C1	2401.920	2401.920	86	28	2780
	
		C93	2481.408	2481.408	89	24	2872
		C94	2482.272	2482.272	89	25	2873
RX	110.592 (for 10.368 MHz REF_CLK recommended)	C0	2401.056	2290.464	82	27	2651
		C1	2401.920	2291.328	82	28	2652
	
		C93	2481.408	2370.816	85	24	2744
		C94	2482.272	2371.680	85	25	2745
RX	112.320 (for 13.824 MHz REF_CLK recommended)	C0	2401.056	2288.736	82	25	2649
		C1	2401.920	2289.600	82	26	2650
	
		C93	2481.408	2369.088	85	22	2742
		C94	2482.272	2369.952	85	23	2743

Formula

TX: $f_{ANT} = f_{VCO} = 864 \text{ kHz} \times (32 \times S_{MC} + S_{SC})$

RX: $f_{ANT} = 864 \text{ kHz} \times (32 \times S_{MC} + S_{SC}) + f_{IF}$

4. Control Signals

Table 4-1. Control Signals – Functions

Signal	Functions
I_CPSW	Charge pump current control
PU_REG	Activates AUX voltage regulator supplying the complete transceiver
PU_RX/TX	Activates RX/TX blocks
PU_PLL	Activates PLL circuits: PC, PD, CP, RC, VCO
RX_ON	Activates RX circuits: BBF, DEMOD, IF AMP, IR MIXER
TX_ON	Activates TX circuits: TX-DRIVER, RAMP GEN, Starts RAMP SIGNAL at RAMP OUT
OLE	Activates open loop mode of the PLL
Data Word 1, bit D0	Activates GF

Table 4-2. Control Signals – Modes

Modes	TX Mode	RX Mode	RSSI Only
PU_REG	1	1	1
PU_VCO	1	1	1
PU_RX/TX	1	1	1
PU_PLL	1	1	1
RX_ON	0	1	1
TX_ON	1	0	1
BB filter	OFF	ON	OFF
Demodulator	OFF	ON	OFF
IF amplifiers and RSSI	OFF	ON	ON
IR mixer	OFF	ON	ON
RX switch	OFF	ON	ON
TX switch	ON	OFF	OFF
TX driver	ON	OFF	OFF
Ramp generator	ON	OFF	OFF
Programmable counter	ON	ON	ON
Voltage-controlled oscillator	ON	ON	ON
Gaussian filter	ON	OFF	OFF
Phase detector/charge pump	ON	ON	ON
Reference counter	ON	ON	ON
Typical current consumption at $V_S = 3.2V$	56 mA	85 mA	82 mA

5. Serial Programming Bus

The transceiver is programmed by the 3-wire bus (CLOCK, DATA and ENABLE).

After setting enable signal to low condition, on the rising edge of the clock signal, the data is transferred bit by bit into the shift register, starting with the MSB-bit. When the enable signal has returned to high condition, the programmed information is loaded into the addressed latches according to the address bit condition (last bit). Additional leading bits are ignored and there is no check made how many pulses arrived during enable low condition. During enable low condition, the bus current is increased to speed up the bus logic.

The programming of the transceiver is separated into two data words. Data word 1 controls mainly the channel information together with settings, which are closely related with the channel. Data word 2 holds setup information, which is adjusted during production.

5.1 Data Word 1

MSB																				LSB			
Data bits																				Address bit			
D22	D21	D20	D19	D18	D17	D16	D15	D14	D13	D12	D11	D10	D9	D8	D7	D6	D5	D4	D3	D2	D1	D0	A0
RC	SC					MC				VS	x	0	GFCS			0	0	0	0	CPCS		GF	1

D11 = x: do not care

5.2 Data Word 2

E12	E11	E10	E9	E8	E7	E6	E5	E4	E3	E2	E1	E0	A0
PA		DEMOMDAC/RAMPDAC					x	x	x	TEST			0

E3, E4, E5 = x: do not care

6. Data Word 1 Programs

6.1 PLL Settings

Table 6-1. With the Reference Counter bits D22-D22

RC (Reference Counter)		
D22	S _{RC}	REF_CLK
0	6	10.368 MHz
1	8	13.824 MHz

Table 6-2. With the Main Counter bits D13-D16

MC (Main Counter)				
D16	D15	D14	D13	S _{MC}
0	0	0	0	80
0	0	0	1	81
...
1	1	1	0	94
1	1	1	1	95

Table 6-3. With the Swallow Counter bits D17-D21

SC (Swallow Counter)					
D21	D20	D19	D18	D17	S _{SC}
0	0	0	0	0	0
0	0	0	0	1	1
0	0	0	1	0	2
...
1	1	1	0	1	29
1	1	1	1	0	30
1	1	1	1	1	31

6.2 VCO Selection

Table 6-4. With bit D12

VCO Selection	
D12	VCO Mode
0	VCO 1
1	VCO 2

6.3 Gaussian Filter On/off

Table 6-5. With bit D0, GF is used only in TX mode

D0	GF (Gaussian Filter)
0	OFF
1	ON

6.4 GFCS Adjustment

Table 6-6. With bits D7-D9, only in TX mode effective for setting the frequency deviation of the modulation

GFCS (Gaussian Filter Settings)			
D9	D8	D7	GFCS
0	0	0	60%
0	0	1	70%
0	1	0	80%
0	1	1	90%
1	0	0	100%
1	0	1	110%
1	1	0	120%
1	1	1	130%

6.5 CPCS Adjustment

Table 6-7. With bits D1-D2

CPCS (Charge-Pump Current Settings)		
D2	D1	CPCS
0	0	-1
0	1	0
1	0	1
1	1	2

Note: Used to adjust the charge pump current. This can be used to compensate the change of the tuning sensitivity over frequency and device tolerances.

7. Data Word 2 Programs

7.1 DEMODDAC Adjustment

Table 7-1. With bits E6-E10

Demod DAC Voltage					
E10	E9	E8	E7	E6	$f_{IFcenter}$ %
0	0	0	0	0	-5
0	0	0	0	1	...
0	0	0	1	0	...
...
1	1	1	0	1	...
1	1	1	1	0	...
1	1	1	1	1	5

Note: Only in RX mode effective. Used to tune the demodulator center frequency and allows to compensate tolerances of external components and the T2803.

7.2 RAMPDAC Adjustment for TX Mode

Table 7-2. With bits E6-E10

RAMPDAC Voltage (at Pin 36 RAMP_OUT)					
E10	E9	E8	E7	E6	V _{RAMP_OUT}
0	0	0	0	0	1.1V
0	0	0	0	1	...
0	0	0	1	0	...
...
1	0	1	1	1	1.68V
1	1	0	0	0	1.7V
...
1	1	1	1	0	...
1	1	1	1	1	1.7V

Note: Only in TX mode effective. Used to control the power of the external PA by adjusting the ramping voltage

7.3 TEST Mode Settings

Table 7-3. With bits E0-E2

E2	E1	E0	Signal at Lock Detect Output	CP Mode
0	0	0	Lock detect	Active
0	0	1	PC out/2	Active
0	1	0	RC out/2	Active
0	1	1	do not care	Active
1	0	0	Lock detect	Active
1	0	1	PC out/2	Active
1	1	0	RC out/2	Active
1	1	1	GFTEST: RC out	Active

Note: In normal operation Lock detect output is used. All other settings are for test only.

7.4 Output Power Settings

Table 7-4. With bits E11-E12

PA (Output Power Settings)		
E12	E11	PA
0	0	-21 dBm
0	1	-11 dBm
1	0	-4 dBm
1	1	+3 dBm

Note: Use of maximum power (+3 dBm) for external PA is recommended.

Figure 7-1. 3-wire Bus Protocol Timing Diagram

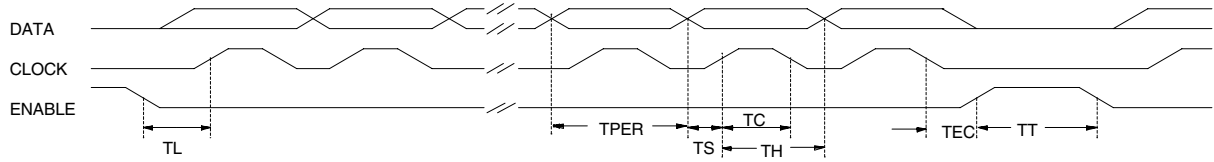
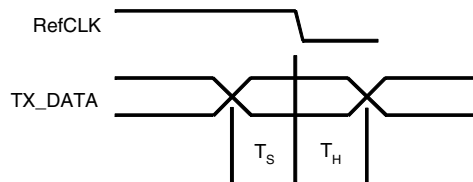

Table 7-5. 3-wire bus Protocol Table

Description	Symbol	Minimum Value	Unit
Clock period	TPER	125	ns
Set time data to clock	TS	60	ns
Hold time data to clock	TH	60	ns
Clock pulse width	TC	125	ns
Set time enable to clock	TL	200	ns
Hold time enable to data	TEC	0	ns
Time between two protocols	TT	250	ns

Figure 7-2. TX DATA Timing



Set-up time TX DATA	TS	> 8 ns	When using REFCLK = 10.368 MHz, TS and TH must be considered for falling and rising edge of REFCLK
Hold time TX DATA	TH	> 8 ns	

8. Absolute Maximum Ratings

Stresses beyond those listed under “Absolute Maximum Ratings” may cause permanent damage to the device. This is a stress rating only and functional operation of the device at these or any other conditions beyond those indicated in the operational sections of this specification is not implied. Exposure to absolute maximum rating conditions for extended periods may affect device reliability.

All voltages refer to GND

Parameters	Pin	Symbol	Min.	Max.	Unit
Supply voltage regulator	10	V_{S_REG}	3.2	4.7	V
Supply voltage	7, 12, 14, 33, 42	V_S	3.0	4.7	V
Logic input voltage	1, 2, 3, 38, 39, 44-48	V_{IN}	-0.3	V_S	V
Junction temperature		T_{jmax}		125	°C
Storage temperature		T_{stg}	-40	150	°C

9. Thermal Resistance

Parameters	Symbol	Value	Unit
Junction ambient	R_{thJA}	25	K/W

10. Handling

Do not operate this part near strong electrostatic fields. This IC meets class 1 ESD test requirement (HBM in accordance to EIA/JESD22-A114-A (October 97) and class A ESD test requirement (MM) in accordance to EIA/JESD22-A115A.

11. Operating Range

Parameters	Pin	Symbol	Min.	Typ.	Max.	Unit
Supply voltage regulator	10	V_{S_REG}	3.2	3.6	4.6	V
Supply voltage	7, 14, 33, 42	V_S	2.9	3.0	4.6	V
Supply voltage charge pump	12	V_{SCP}	V_S		4.6	V
Ambient temperature		T_{amb}	-10		+60	°C

12. Electrical Characteristics

Test conditions (unless otherwise specified): $V_{S_REG} = 3.2\text{ V}$, $T_{amb} = 25^\circ\text{C}$

Parameters	Test Conditions/Pins	Symbol	Min.	Typ.	Max.	Unit
IR Mixer (Pins 29, 30, 40 and 41)						
Input impedance	Pins 29 or 30 (single ended)	Z_{in}		110 + j12		Ω
Image rejection ratio	Pins 40 and 41	IRR		20		dB
DSB noise figure	Pins 29 or 30 (single ended)	NFDSB = NFSSB		10		dB
Conversion gain	$R_{load} = 200\Omega$	G_{conv}		11		dB
Input intercept point	Pins 29 or 30 (single ended)	IIP3		-7		dBm
Output impedance	Pin 40 and 41 (differential)	Z_{OUT}		175 + j145		Ω
IF Amplifier (Pins 26, 27, 34 and 35)						
Input impedance	Pins 34 and 35 (differential)	Z_{in}		1200 – j480		Ω
Lower cut-off frequency		f_{3dB}		90		MHz
Upper cut-off frequency		f_{u3dB}		130		MHz
Power gain		G_p		85		dB
Bandwidth of external tank circuit	Pins 26 and 27	BW3dB		10		MHz
Noise figure		NF		9		dB
RSSI (Pins 25, 34 and 35)						
RSSI sensitivity	At IF_IN1,2; pins 34 and 35	P_{min}		20		dB μ V
RSSI compression	At IF_IN1,2; pins 34 and 35	P_{max}		100		dB μ V
RSSI dynamic range		DR		80		dB
RSSI resolution	Slope of the RSSI has to be steady	Acc		± 2		dB
RSSI rise time	$P_{in} = 30$ to 100 dB μ V, pin 25	t_r		1		μ s
RSSI fall time	$P_{in} = 100$ to 30 dB μ V, pin 25	t_f		1		μ s
Quiescent output voltage	At $P_{in} < 20$ dB μ V at IF_IN1, IF_IN2, pin 25	V_{out}		0.4		V
Maximum output voltage	At $P_{in} = 100$ dB μ V at IF_IN1, IF_IN2, pin 25	V_{out}		1.9		V
FM Demodulator, BB-filter (Pins 19, 20, 23 and 24)						
Co-channel rejection ratio	at $P_{in} = -75$ dBm at IR-mixer input	CCRR		10		dB
Sensitivity	Quality factor of external tank circuit approximately 20, $f_{res} = F_{IF}/2$, pin 24	S		0.5		V/MHz
Amplitude of recovered signal	Nominal deviation of signal ± 400 kHz, pin 24	A		450		mVpp
Corner frequency	Pin 23: C = 68 pF	f_c		680		kHz
Output voltage DC range	Pin 24	V_{outDC}	1		$V_S - 1$	V
DEMOD_DAC range	(see bus protocol E6 to E10)	$\Delta f_{IFcenter}$		± 5		%
VCOs						
Frequency range	VCO 1, D12 VS = 1 VCO 2, D12 VS = 0	f_{vco} f_{vco}	2289 2289		2483 2483	MHz MHz
Tuning gain		G_{tune}		200		MHz/V
Frequency control voltage range	Pin 17	V_{tune}	0.4		2.8	V

12. Electrical Characteristics (Continued)

Test conditions (unless otherwise specified): $V_{S_REG} = 3.2\text{ V}$, $T_{amb} = 25^\circ\text{C}$

Parameters	Test Conditions/Pins	Symbol	Min.	Typ.	Max.	Unit
PLL						
Scaling factor prescaler		S_{PSC}		32/33		
Scaling factor main counter		S_{MC}		82-89		
Scaling factor swallow counter		S_{SC}	0		31	
External reference input frequency	AC coupled sinewave, pin 4	f_{REF_CLK}		10.368 13.824		MHz MHz
External reference input voltage	AC coupled sinewave, pin 4	V_{REF_CLK}	50		250	mV _{RMS}
Scaling factor reference counter		S_{RC}		6/8		
Charge Pump (Pin 13)						
Output current	$V_{CP} = V_{VS_CP}/2$, $I_{CPSW} = 1$, pin 48	I_{CP_nom}		± 7.5		mA
Output current	$V_{CP} = V_{VS_CP}/2$, $I_{CPSW} = 0$, pin 48	I_{CP_nom}		± 1.2		mA
Current scaling	$I_{CP} = I_{CP_nom} + CPCS \times I_{CP_step}$ (see bus protocol D1 ... D2)	I_{CP_step}		0.2		mA
Leakage current	$OLE = 1$	I_L		± 100		pA
Gaussian Transmit Filter (Gaussian Shape $B \times T = 0.5$)						
Tx data rate				1152		kBit/s
Tx data filter clock	6 taps in filter	f_{TXFCLK}		6.912		MHz
Frequency deviation		GF_{FM_nom}		± 400		kHz
Frequency deviation scaling	$GF_{FM} = GF_{FM_nom} \times GFCS$ (see bus protocol D7 ... D9)	GFCS	60		130	%
TX Driver (Pin 32)						
Maximum output power	At $L = 5.6\text{ nH}$, pin 32 (see bus protocol E11-E12)	P_{TX}		3		dBm
Minimum output power	At $L = 5.6\text{ nH}$, pin 32 (see bus protocol E11-E12)	P_{TX}		-21		dBm
RF leakage	In RX mode	P_{leak}			-47	dBm
Output impedance	At $L = 5.6\text{ nH}$, 2.5 GHz, pin 32	Z_{OUT}		$13+j40$		Ω
Ramp Generator (Pins 36 and 37)						
Minimum output voltage		V_{min}		0.7		V
Maximum output voltage	(see bus protocol E6-E10)	V_{max}	1.1		1.8	V
Rise time	$C_{ramp} = 270\text{ pF}$ at pin 37	t_r		5		μs
Fall time	$C_{ramp} = 270\text{ pF}$ at pin 37	t_f		5		μs
Lock Detect and Test Mode Output (Pin 5)						
Lock detect output, test mode output	Locked = 1, unlocked = 0 Test modes (see bus protocol E0 ... E2)	LD				
Leakage current	$V_{OH} = 4.6\text{ V}$	I_L			5	μA
Saturation voltage	$I_{OL} = 0.5\text{ mA}$	V_{SL}			0.4	V
Auxiliary Regulator (Pins 8, 9 and 10)						
Output voltage	$V_{SREG} = 3\text{ V}$, pin 8	V_{REG}	2.9	3.0	3.1	V
VCO Regulator (Pins 14, 15 and 12)						
Output voltage	$V_{SVCO} = 3\text{ V}$, pin 15	V_{REG_VCO}	2.6	2.7	2.8	V

12. Electrical Characteristics (Continued)

Test conditions (unless otherwise specified): $V_{S_REG} = 3.2\text{ V}$, $T_{amb} = 25^\circ\text{C}$

Parameters	Test Conditions/Pins	Symbol	Min.	Typ.	Max.	Unit
3-wire Bus						
Clock		f_{Clock}			6.912	MHz
Logic Input Levels (CLOCK, DATA, ENABLE, RX_ON, TX_ON, OLE, TX_DATA, DATA_HOLD) (Pins 1, 2, 3, 38, 39, 44, 47 and 48)						
High input level	= 1	V_{IH}	1.5			V
Low input level	= 0	V_{iL}			0.5	V
High input current	= 1	I_{iH}	-5		5	μA
Low input current	= 0	I_{iL}	-5		5	μA
Standby Control (Pins 6, 45 and 46)						
Power Up PU_REG = 1 PU_RX/TX = 1 PU_PLL = 1 High input level	Pin 6 Pin 45 Pin 46	V_{PU_REG} $V_{PU_RX/TX}$ V_{PU_PLL}	2.0			V
Standby PU_REG = 0 PU_RX/TX = 0 PU_PLL = 0 Low input level	Pin 6 Pin 45 Pin 46	$V_{PU_REG,OFF}$ $V_{PU_RX/TX,OFF}$ $V_{PU_PLL,OFF}$			0.7	V
Power Up PU_REG = 1 PU_RX/TX = 1	$V_{PU} = 3\text{V}$, pin 6 $V_{PU} = 4.6\text{V}$, pin 45	I_{PU_REG} $I_{PU_RX/TX}$	20 60	30 80	40 100	μA μA
PU_PLL = 1 High input current	$V_{PU} = 3\text{V}$, pin 46 $V_{PU} = 4.6\text{V}$	I_{PU_PLL}	100 200	125 300	150 400	μA μA
Standby PU_xxxx = 0 Low input current	$V_{PU} = 0\text{V}$, pin 6 $V_{PU} = 0.5\text{V}$, pins 45, 46	$I_{PU,OFF}$			0.1 1	μA μA
Settling Time $V_S = 0 \rightarrow$ active operation	Switched from $V_S = 0$ to $V_S = 3\text{V}$	t_{soa}		< 10		μs
Settling Time standby \rightarrow active operation	Switched from PU = 0 to PU = 1	t_{ssa}		< 10		μs
Settling Time active operation \rightarrow standby	Switched from PU = 1 to standby	t_{sas}		< 2		μs
Power Supply (Pins 7, 10, 12, 14, 33 and 42)						
Total supply current	RX	I_S		85		mA
	RSSI only	I_S		82		mA
	TX	I_S		54		mA
	TX (GF active)	I_S		56		mA
Standby current	PU_RX/TX = GND	I_S			10	μA
Supply current CP	$V_{VS_CP} = 3\text{V}$, PLL in lock condition, Pin 13	I_{CP}		1		μA

Figure 12-1. Typical Application Circuit

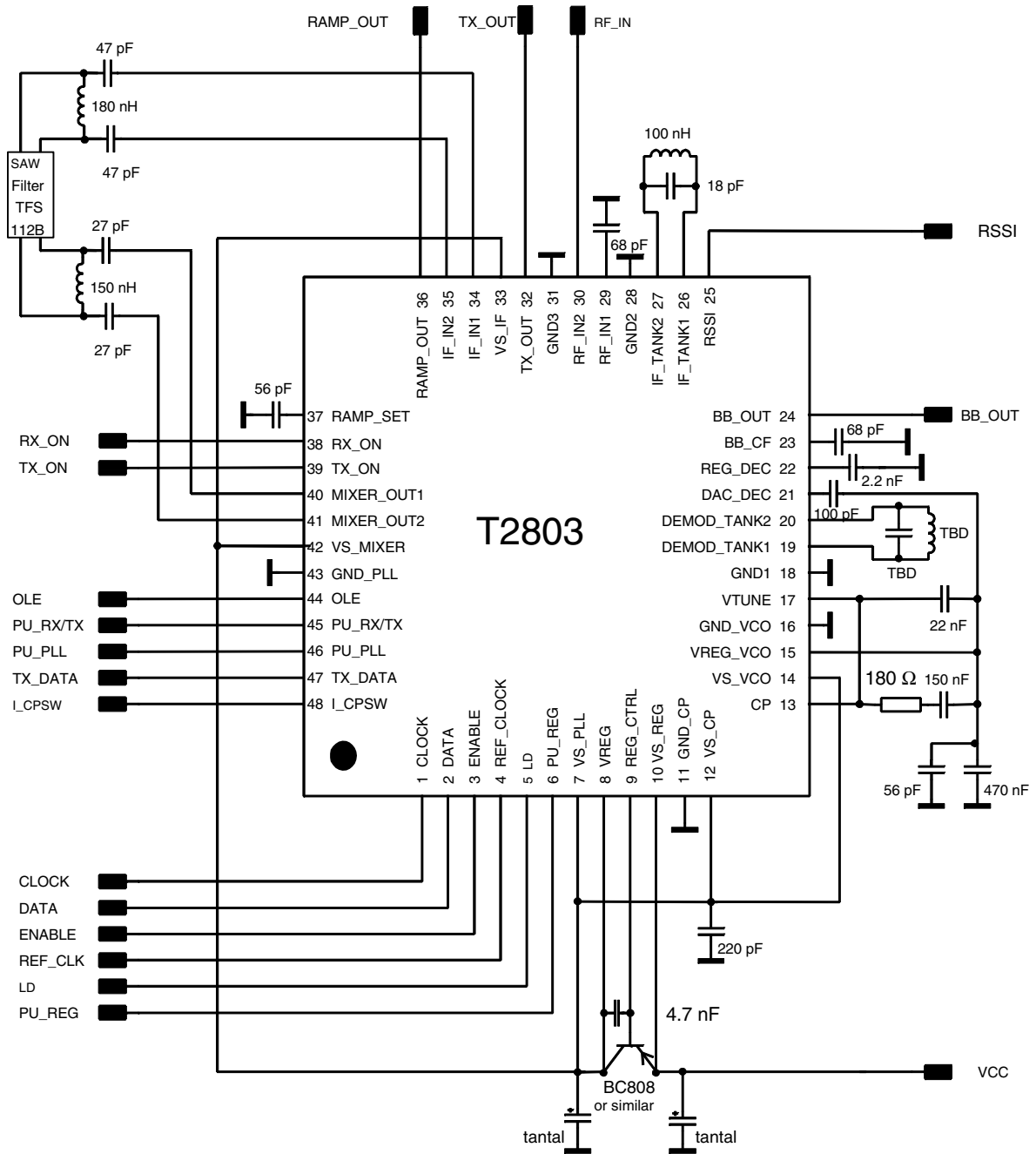

13. Ordering Information

Extended Type Number	Package	Remarks	MOQ
T2803-PLQ	QFN48	Taped and reeled	4000 pcs.
T2803-PLQW	QFN48, Pb-free, halogen-free	Taped and reeled	4000 pcs.

14. Package Information

Package: QFN 48 - 7x7
 Exposed pad 4.5x4.5
 (acc. JEDEC OUTLINE No. MO-220)
 Dimensions in mm

Not indicated tolerances ±0.05

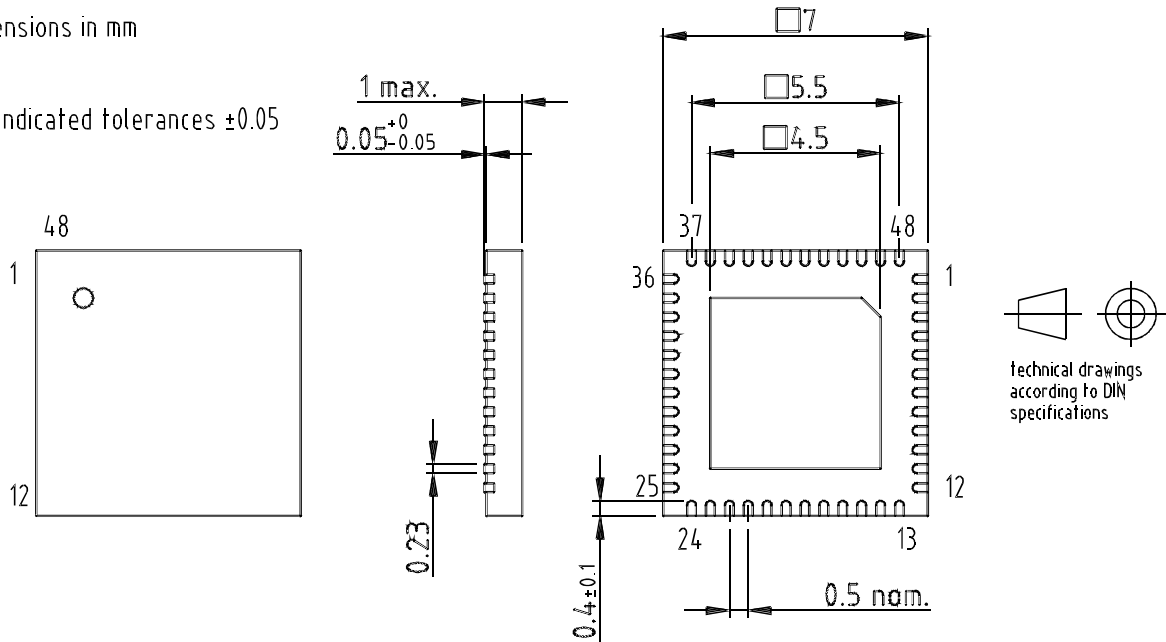

technical drawings according to DIN specifications

Drawing-No.: 6.543-5089.01-4
 Issue: 2; 24.01.03



Atmel Corporation

2325 Orchard Parkway
San Jose, CA 95131, USA
Tel: 1(408) 441-0311
Fax: 1(408) 487-2600

Regional Headquarters

Europe

Atmel Sarl
Route des Arsenaux 41
Case Postale 80
CH-1705 Fribourg
Switzerland
Tel: (41) 26-426-5555
Fax: (41) 26-426-5500

Asia

Room 1219
Chinachem Golden Plaza
77 Mody Road Tsimshatsui
East Kowloon
Hong Kong
Tel: (852) 2721-9778
Fax: (852) 2722-1369

Japan

9F, Tonetsu Shinkawa Bldg.
1-24-8 Shinkawa
Chuo-ku, Tokyo 104-0033
Japan
Tel: (81) 3-3523-3551
Fax: (81) 3-3523-7581

Atmel Operations

Memory

2325 Orchard Parkway
San Jose, CA 95131, USA
Tel: 1(408) 441-0311
Fax: 1(408) 436-4314

Microcontrollers

2325 Orchard Parkway
San Jose, CA 95131, USA
Tel: 1(408) 441-0311
Fax: 1(408) 436-4314

La Chantrerie
BP 70602
44306 Nantes Cedex 3, France
Tel: (33) 2-40-18-18-18
Fax: (33) 2-40-18-19-60

ASIC/ASSP/Smart Cards

Zone Industrielle
13106 Rousset Cedex, France
Tel: (33) 4-42-53-60-00
Fax: (33) 4-42-53-60-01

1150 East Cheyenne Mtn. Blvd.
Colorado Springs, CO 80906, USA
Tel: 1(719) 576-3300
Fax: 1(719) 540-1759

Scottish Enterprise Technology Park
Maxwell Building
East Kilbride G75 0QR, Scotland
Tel: (44) 1355-803-000
Fax: (44) 1355-242-743

RF/Automotive

Theresienstrasse 2
Postfach 3535
74025 Heilbronn, Germany
Tel: (49) 71-31-67-0
Fax: (49) 71-31-67-2340

1150 East Cheyenne Mtn. Blvd.
Colorado Springs, CO 80906, USA
Tel: 1(719) 576-3300
Fax: 1(719) 540-1759

Biometrics/Imaging/Hi-Rel MPU/ High Speed Converters/RF Datacom

Avenue de Rochepleine
BP 123
38521 Saint-Egreve Cedex, France
Tel: (33) 4-76-58-30-00
Fax: (33) 4-76-58-34-80

Literature Requests

www.atmel.com/literature

Disclaimer: The information in this document is provided in connection with Atmel products. No license, express or implied, by estoppel or otherwise, to any intellectual property right is granted by this document or in connection with the sale of Atmel products. **EXCEPT AS SET FORTH IN ATMEL'S TERMS AND CONDITIONS OF SALE LOCATED ON ATMEL'S WEB SITE, ATMEL ASSUMES NO LIABILITY WHATSOEVER AND DISCLAIMS ANY EXPRESS, IMPLIED OR STATUTORY WARRANTY RELATING TO ITS PRODUCTS INCLUDING, BUT NOT LIMITED TO, THE IMPLIED WARRANTY OF MERCHANTABILITY, FITNESS FOR A PARTICULAR PURPOSE, OR NON-INFRINGEMENT. IN NO EVENT SHALL ATMEL BE LIABLE FOR ANY DIRECT, INDIRECT, CONSEQUENTIAL, PUNITIVE, SPECIAL OR INCIDENTAL DAMAGES (INCLUDING, WITHOUT LIMITATION, DAMAGES FOR LOSS OF PROFITS, BUSINESS INTERRUPTION, OR LOSS OF INFORMATION) ARISING OUT OF THE USE OR INABILITY TO USE THIS DOCUMENT, EVEN IF ATMEL HAS BEEN ADVISED OF THE POSSIBILITY OF SUCH DAMAGES.** Atmel makes no representations or warranties with respect to the accuracy or completeness of the contents of this document and reserves the right to make changes to specifications and product descriptions at any time without notice. Atmel does not make any commitment to update the information contained herein. Unless specifically provided otherwise, Atmel products are not suitable for, and shall not be used in, automotive applications. Atmel's products are not intended, authorized, or warranted for use as components in applications intended to support or sustain life.

© Atmel Corporation 2005. All rights reserved. Atmel®, logo and combinations thereof, Everywhere You Are® and others, are registered trademarks or trademarks of Atmel Corporation or its subsidiaries. Other terms and product names may be trademarks of others.



Printed on recycled paper.