

**SDRAM****1M x 16 SDRAM**  
**512K x 16bit x 2Banks Synchronous DRAM****FEATURES**

- 3.3V power supply
- Clock cycle time : 6 / 7 ns
- Dual banks operation
- LVTTL compatible with multiplexed address
- All inputs are sampled at the positive going edge of system clock
- Burst Read Single-bit Write operation
- DQM for masking
- Auto refresh and self refresh
- 32ms refresh period (2K cycle)
- MRS cycle with address key programs
  - CAS Latency ( 2 & 3 )
  - Burst Length ( 1 , 2 , 4 , 8 & full page)
  - Burst Type (Sequential & Interleave)
- Available package type :
  - 50 pin TSOP(II)/lead-free
- Operating temperature :
  - 0 ~ +70 °C

**GRNERAL DESCRIPTION**

The T431616C is 16,777,216 bits synchronous high data rate Dynamic RAM organized as 2 x 524,288 words by 16 bits , fabricated with high performance CMOS technology . Synchronous design allows precise cycle control with the use of system clock I/O transactions are possible on every clock cycle . Range of operating frequencies , programmable burst length and programmable latencies allow the same device to be useful for a variety of high bandwidth , high performance memory system applications.

**ORDERING INFORMATION**

<b>PART NO.</b>	<b>CLOCK CYCLE TIME</b>	<b>MAX FREQUENCY</b>	<b>PACKAGE</b>	<b>OPERATING TEMPERATURE</b>
T431616C-6S	6ns	166 MHz	TSOP-II	0 ~ +70 °C
T431616C-6SG	6ns	166 MHz	TSOP-II Lead-free	0 ~ +70 °C
T431616C-7S	7ns	143 MHz	TSOP-II	0 ~ +70 °C
T431616C-7SG	7ns	143 MHz	TSOP-II Lead-free	0 ~ +70 °C

**PIN ARRANGEMENT**

(TSOP-II Top View)

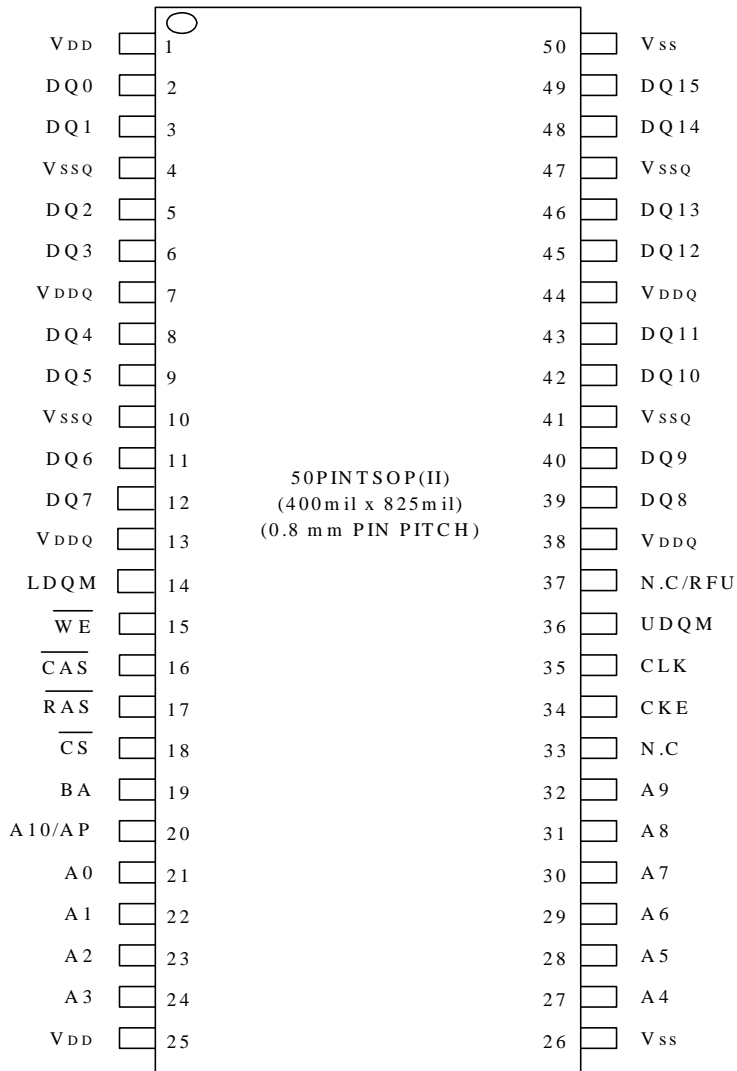

**BLOCK DIAGRAM**

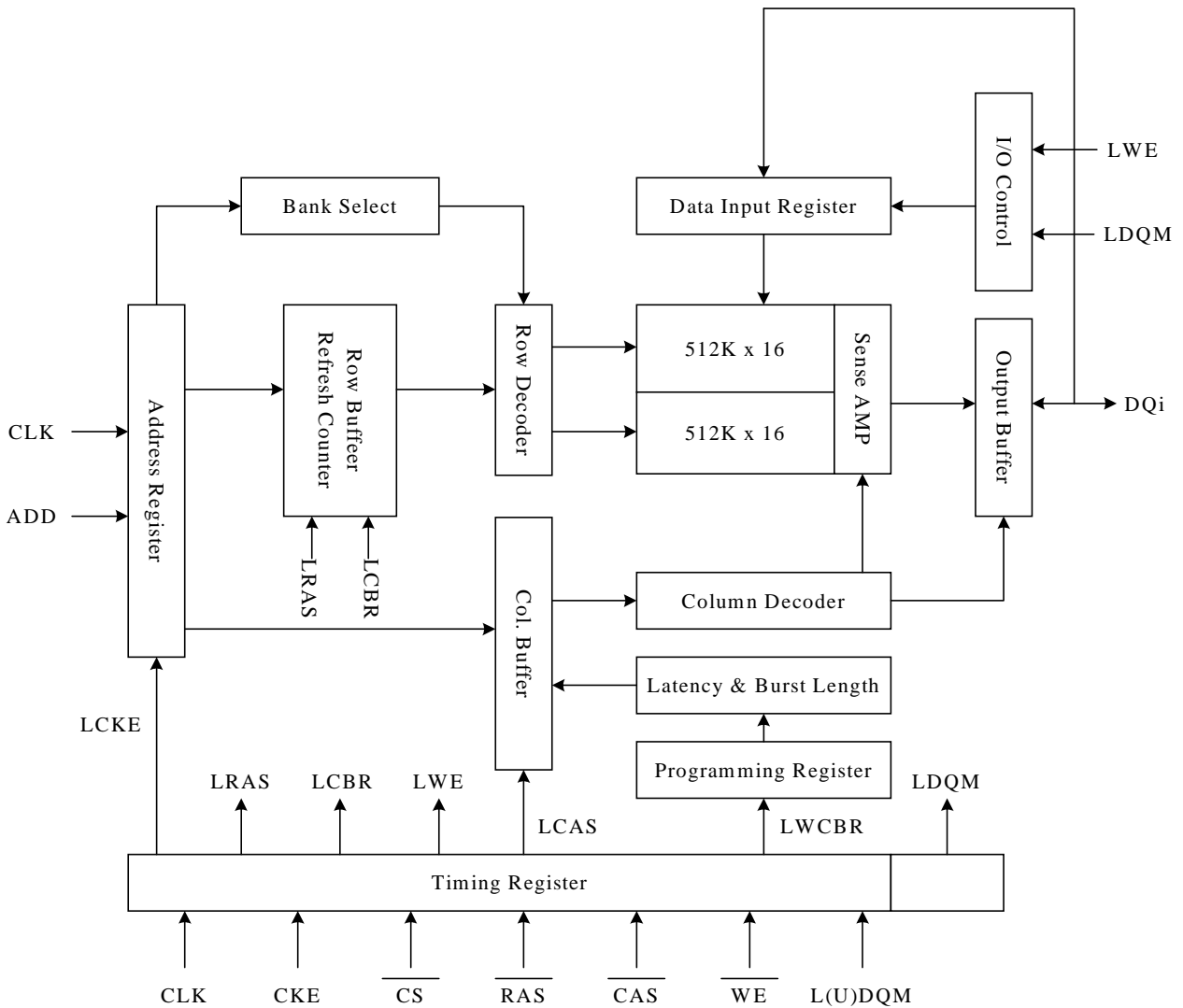

**PIN DESCRIPTION**

PIN	NAME	INPUT FUNCTION
CLK	System Clock	Active on the positive going edge to sample all input.
$\overline{\text{CS}}$	Chip Select	Disables or enables device operation by masking or enabling all input except CLK,CKE and L(U)DQM
CKE	Clock Enable	Masks system clock to freeze operation from the next clock cycle. CKE should be enabled at least one cycle prior to new command. Disable input buffers for power down in standby.
A0 ~ A10/AP	Address	Row/column addresses are multiplexed on the same pins. Row address : RA0 ~ RA10,column address : CA0 ~ CA7
BA	Bank Select Address	Selects bank to be activated during row address latch time. Select bank for read/write during column address latch time.
$\overline{\text{RAS}}$	Row Address Strobe	Latches row addresses on the positive going edge of the CLK with $\overline{\text{RAS}}$ low. Enables row access & precharge.
$\overline{\text{CAS}}$	Column Address Strobe	Latches column addresses on the positive going edge of the CLK with $\overline{\text{CAS}}$ low. Enables column access .
$\overline{\text{WE}}$	Write Enable	Enables write operation and row precharge. Latches data in starting from $\overline{\text{CAS}}$ , $\overline{\text{WE}}$ active.
L(U)DQM	Data Input/Output Mask	Makes data output Hi-Z, tSHZ after the clock and masks the output. Blocks data input when L(U)DQM active.
DQ0 ~ DQ15	Data Input/Output	Data inputs/outputs are multiplexed on the same pins.
V <sub>DD</sub> /V <sub>SS</sub>	Power Supply/Ground	Power and ground for the input buffers and the core logic.
V <sub>DDQ</sub> /V <sub>SSQ</sub>	Data Output Power/Ground	Isolated power supply and ground for the output buffers to provide improved noise immunity.
N.C/RFU	No Connection/Reserved for Future Use	This pin is recommended to be left No Connection on the device.

**ABSOLUTE MAXIMUM RATINGS**

Parameter	Symbol	Value	Unit
Voltage on Any Pin Relative To V <sub>SS</sub>	V <sub>IN</sub> ,V <sub>OUT</sub>	-1.0 to 4.6	V
Supply Voltage Relative To V <sub>SS</sub>	V <sub>DD</sub> ,V <sub>DDQ</sub>	-1.0 to 4.6	V
Short circuit Output Current	I <sub>out</sub>	50	mA
Power Dissipation	P <sub>D</sub>	1	W
Operating Temperature	T <sub>OPR</sub>	0 to +70	°C
Storage Temperature	T <sub>stg</sub>	-55 to +125	°C

**Note :** Permanent device damage may occur if ABSOLUTE MAXIMUM RATINGS are exceeded.  
 Functional operation should be restricted to recommended operating condition.  
 Exposure to higher than recommended voltage for extended periods of time could affect device reliability.

**RECOMMENDED DC OPERATING CONDITIONS**

(T<sub>A</sub> = 0 to +70 °C, Voltage referenced to V<sub>SS</sub>=0V)

Parameter	Symbol	Min.	Typ	Max.	Unit	Notes
Supply Voltage	V <sub>DD</sub> ,V <sub>DDQ</sub>	3.0	3.3	3.6	V	
Input High Voltage	V <sub>IH</sub>	2.0	3.0	V <sub>DD</sub> +0.3V	V	1
Input Low Voltage	V <sub>IL</sub>	-0.3	0	0.8	V	2
Output logic high voltage	V <sub>OH</sub>	2.4	-	-	V	I <sub>OH</sub> =-2mA
Output logic low voltage	V <sub>OL</sub>	-	-	0.4	V	I <sub>OL</sub> =2mA
Input leakage current	I <sub>IL</sub>	-5	-	5	uA	3
Output leakage current	I <sub>OL</sub>	-5	-	5	uA	4

**Note :** 1. V<sub>IH</sub> (max) = 4.6V AC for pulse width ≤ 10ns acceptable.  
 2. V<sub>IL</sub> (min) = -1.0V AC for pulse width ≤ 10ns acceptable.  
 3. Any input 0V ≤ V<sub>IN</sub> ≤ V<sub>DD</sub>+ 0.3V , all other pin are not under test = 0V.  
 4. Dout = disable, 0V ≤ V<sub>OUT</sub> ≤ V<sub>DD</sub> .

**CAPACITANCE**

(T<sub>A</sub> =25 °C, V<sub>DD</sub>=3.3V, f = 1MHz)

Pin	Symbol	Min	Max	Unit
CLOCK	C <sub>CLK</sub>	2.5	4.0	pF
ADDRESS	C <sub>ADD</sub>	2.5	4.0	pF
DQ0 ~ DQ15	C <sub>OUT</sub>	3.0	5.0	pF
RAS,CAS,WE,CS,CKE,LDQM, UDQM	C <sub>IN</sub>	2.5	4.0	pF

**DC CHARACTERISTICS**
 $T_A = 0 \text{ to } 70^\circ\text{C}, V_{IH}(\text{min})/V_{IL}(\text{max})=2.0\text{V}/0.8\text{V}$ 

Parameter	Symbol	Speed version		Unit	Test Condition	Note
		-6	-7			
Operating Current ( One Bank Active)	ICC1	145	140	mA	Burst Length = 1 $t_{RC} \geq t_{RC}(\text{min}), t_{CC} \geq t_{CC}(\text{min}), I_{OL} = 0 \text{ mA}$	1,3
Precharge Standby Current in power- down mode	ICC2P	2		mA	$\text{CKE} \leq V_{IL}(\text{max}), t_{CC} = t_{CC}(\text{min})$	3
	ICC2PS	3			$\text{CKE} \leq V_{IL}(\text{max}), \text{CLK} \leq V_{IL}(\text{max}), t_{CC} = \infty$	
Precharge Standby Current in non power-down mode	ICC2N	30		mA	$\text{CKE} \geq V_{IH}(\text{min}), \overline{\text{CS}} \geq V_{IH}(\text{min}), t_{CC} = t_{CC}(\text{min})$ Input signals are changed one time during 30ns	3
	ICC2NS	2			$\text{CKE} \geq V_{IH}(\text{min}), \text{CLK} \leq V_{IL}(\text{min}), t_{CC} = \infty$ Input signals are stable	
Active Standby Current in power- down mode	ICC3P	10		mA	$\text{CKE} \leq V_{IL}(\text{max}), t_{CC} = t_{CC}(\text{min})$	3
	ICC3PS	10			$\text{CKE} \leq V_{IL}(\text{max}), \text{CLK} \leq V_{IL}(\text{max}), t_{CC} = \infty$	
Active Standby Current in non power-down mode (One Bank Active)	ICC3N	40		mA	$\text{CKE} \geq V_{IH}(\text{min}), \overline{\text{CS}} \geq V_{IH}(\text{min}), t_{CC} = t_{CC}(\text{min})$ Input signals are changed one time during 30ns	3
	ICC3NS	30			$\text{CKE} \geq V_{IH}(\text{min}), \text{CLK} \leq V_{IL}(\text{min}), t_{CC} = \infty$ Input signals are stable	
Operating Current (Burst Mode)	ICC4	150	140	mA	CAS Latency 3   $I_{OL} = 0 \text{ mA}, \text{Page Burst}$	1,3
		150	140		CAS Latency 2   All Band Activated $t_{CCD} = t_{CCD}(\text{min})$	
Refresh Current	ICC5	90	80	mA	$t_{RC} \geq t_{RC}(\text{min})$	2,3
Self refresh Current	ICC6	1		mA	$\text{CKE} \leq 0.2\text{V}$	

- Note:
1. Measured with output open. Addresses are changed only one time during  $t_{CC}(\text{min})$  .
  2. Refresh period is 32ms. Addresses are changed only one time during  $t_{CC}(\text{min})$  .
  3.  $t_{CC}$  : Clock cycle time.  
 $t_{RC}$  : Row cycle time.  
 $t_{CCD}$  : Column address to column address delay time.

**AC OPERATING CONDITIONS**

(V<sub>DD</sub>=3.3V ±0.3V ,T<sub>A</sub>= 0 to 70°C)

Parameter	Value	Unit
Input levels (V <sub>IH</sub> /V <sub>IL</sub> )	2.0 / 0.8	V
Input timing measurement reference level	1.4	V
Input rise and fall time	t <sub>r</sub> / t <sub>f</sub> = 1 / 1	ns
Output timing measurement reference level	1.4	V
Output load condition	See Fig.2	

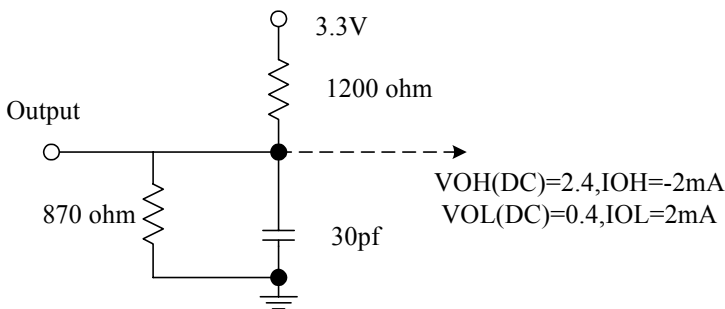

(Fig.1) DC Output Load Circuit

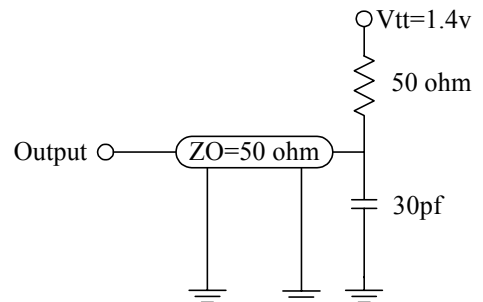

(Fig.2) AC Output Load Circuit

**OPERATING AC PARAMETER**

(AC operating conditions unless otherwise noted)

Parameter	Symbol	Speed Version		Unit	Note
		-6	-7		
Row active to row active delay	tRRD(min)	12	14	ns	1
RAS to CAS delay	tRCD(min)	18	21	ns	1
Row precharge time	tRP(min)	18	21	ns	1
Row active time	tRAS(min)	36	42	ns	1
	tRAS(max)	100K		ns	
Row cycle time	tRC(min)	60	70	ns	1
Last data in to new col. Address delay	tCDL(min)	1		CLK	2
Last data in to row precharge	tRDL(min)	2		CLK	2
Last data in to burst stop	tBDL(min)	1		CLK	2
Col. Address to col. Address delay	tCCD(min)	1		CLK	3
Number of valid output data	CAS latency=3	1		ea	4
	CAS latency=2	1			

Note: 1. The minimum number of clock cycles is determined by dividing the minimum time required with clock cycle time and then rounding off to the next higher integer.

2. Minimum delay is required to complete write.

3. All parts allow every cycle column address change.

4. In case of row precharge interrupt, auto precharge and read burst stop.

The earliest a precharge command can be issued after a Read command without the loss of data is CL + BL-2 clocks.



**AC CHARACTERISTICS**

(AC operating conditions unless otherwise noted)

Parameter		Symbol	-6		-7		Unit	Note
			Min	Max	Min	Max		
CLK cycle time	CAS Latency = 3	t <sub>CC</sub>	6	1K	7	1K	ns	1
	CAS Latency = 2		8		8.6			
CLK to valid Output delay	CAS Latency = 3	t <sub>SAC</sub>	-	5.5	-	6	ns	1
	CAS Latency = 2		-	6	-	6	ns	
Output data hold time		t <sub>OH</sub>	1		1		ns	2
CLK high pulse width		t <sub>CH</sub>	2		2.5		ns	3
CLK low pulse width		t <sub>CL</sub>	2		2.5		ns	3
Input setup time		t <sub>SS</sub>	2		2		ns	3
Input hold time		t <sub>SH</sub>	1		1		ns	3
CLK to output in Low-Z		t <sub>SLZ</sub>	1		1		ns	2
CLK to output in Hi-Z	CAS Latency = 3	t <sub>SHZ</sub>	-	5.5	-	6	ns	
	CAS Latency = 2		-	6	-	6	ns	

Note: 1. Parameters depend on programmed CAS latency.

2. If clock rising time is longer than 1ns, (tr/2-0.5)ns should be added to the parameter.

3. Assumed input rise and fall time (tr & tf)=1ns.

If tr & tf is longer than 1ns, transient time compensation should be considered, i.e., [(tr+tf)/2-1]ns should be added to the parameter.

**FREQUENCY vs. AC PARAMETER RELATIONSHIP TABLE**
**T431616C-6S**

(Unit : number of clock)

Frequency	CAS Latency	t <sub>RC</sub>	t <sub>RAS</sub>	t <sub>RP</sub>	t <sub>RRD</sub>	t <sub>RCD</sub>	t <sub>CCD</sub>	t <sub>CDL</sub>	t <sub>RDL</sub>
		60ns	36ns	18ns	12ns	18ns	6ns	6ns	12ns
166MHz(6.0ns)	3	10	6	3	2	3	1	1	2
143MHz(7.0ns)	3	9	6	3	2	3	1	1	2
125MHz(8.0ns)	2	8	5	3	2	3	1	1	2
111MHz(9.0ns)	2	7	4	2	2	2	1	1	2
100MHz(10.0ns)	2	6	4	2	2	2	1	1	2

**T431616C-7S**

(Unit : number of clock)

Frequency	CAS Latency	t <sub>RC</sub>	t <sub>RAS</sub>	t <sub>RP</sub>	t <sub>RRD</sub>	t <sub>RCD</sub>	t <sub>CCD</sub>	t <sub>CDL</sub>	t <sub>RDL</sub>
		70ns	42ns	21ns	14ns	21ns	7ns	7ns	14ns
143MHz(7.0ns)	3	10	6	3	2	3	1	1	2
125MHz(8.0ns)	3	9	6	3	2	3	1	1	2
111MHz(9.0ns)	2	8	5	3	2	3	1	1	2
100MHz(10.0ns)	2	7	5	3	2	3	1	1	2
83MHz(12.0ns)	2	6	4	2	2	2	1	1	2

Note : 1. Clock count formula :  $\text{clock} \geq \frac{\text{base value}}{\text{clock period}}$  (round off whole number).

**MODE REGISTER**

11	10	9	8	7	6	5	4	3	2	1	0
0	0	0	0	1							

JEDEC Standard Test Set (refresh counter test)

11	10	9	8	7	6	5	4	3	2	1	0
x	x	1	0	0	LTMODE	WT	BL				

Burst Read and Single Write (for Write Through Cache)

11	10	9	8	7	6	5	4	3	2	1	0
			1	0							

Use in future

11	10	9	8	7	6	5	4	3	2	1	0
x	x	x	1	1	v	v	v	v	v	v	v

Vender Specific

11	10	9	8	7	6	5	4	3	2	1	0
0	0	0	0	0	LTMODE	WT	BL				

Mode Register Set

v = Valid  
x = Don't care

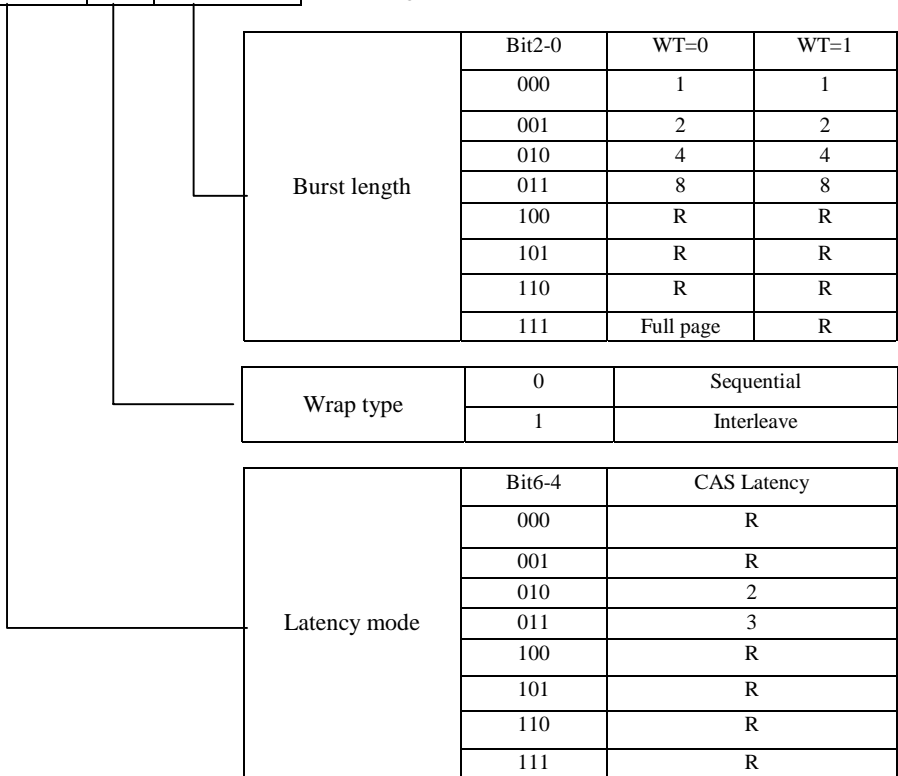

Remark R : Reserved

**Mode Register Write Timing**

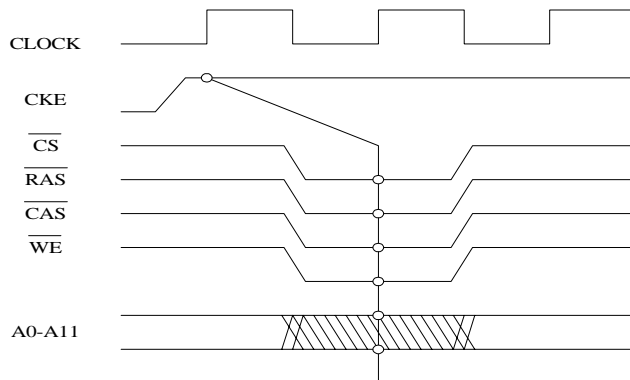

## Burst Length and Sequence

(Burst of Two)

Starting Address (column address A0 binary)	Sequential Addressing Sequence (decimal)	Interleave Addressing Sequence (Decimal)
0	0,1	0,1
1	1,0	1,0

(Burst of Four)

Starting Address (column address A1-A0 binary)	Sequential Addressing Sequence (decimal)	Interleave Addressing Sequence (Decimal)
00	0,1,2,3	0,1,2,3
01	1,2,3,0	1,0,3,2
10	2,3,0,1	2,3,0,1
11	3,0,1,2	3,2,1,0

(Burst of Eight)

Starting Address (column address A2-A0 binary)	Sequential Addressing Sequence (decimal)	Interleave Addressing Sequence (Decimal)
000	0,1,2,3,4,5,6,7	0,1,2,3,4,5,6,7
001	1,2,3,4,5,6,7,0	1,0,3,2,5,4,7,6
010	2,3,4,5,6,7,0,1	2,3,0,1,6,7,4,5
011	3,4,5,6,7,0,1,2	3,2,1,0,7,6,5,4
100	4,5,6,7,0,1,2,3	4,5,6,7,0,1,2,3
101	5,6,7,0,1,2,3,4	5,4,7,6,1,0,3,2
110	6,7,0,1,2,3,4,5	6,7,4,5,2,3,0,1
111	7,0,1,2,3,4,5,6	7,6,5,4,3,2,1,0

Full page burst is an extension of the above tables of Sequential Addressing, with the length being 256 for 1Mx16 device.

## POWER UP SEQUENCE

1. Apply power and start clock, attempt to maintain CKE = 'H' , L(U)DQM = 'H' and the other pin are NOP condition at the inputs.
2. Maintain stable power, stable clock and NOP input condition for a minimum of 200us.
3. Issue precharge commands for all banks of the devices.
4. Issue 2 or more auto-refresh commands.
5. Issue mode register set command to initialize the mode register.  
Cf.) Sequence of 4 & 5 is regardless of the order.

**SIMPLIFIED TRUTH TABLE**

COMMAND		CKEn-1	CKEn	$\overline{CS}$	$\overline{RAS}$	$\overline{CAS}$	$\overline{WE}$	DQM	BA	A10/AP	A9~A0	Note
Register	Mode Register Set	H	X	L	L	L	L	X		X		1,2
Refresh	Auto Refresh	H	H	L	L	L	H	X		X		3
	Self Refresh		Entry									
		Exit	L	H	L	H	H	X	X	X		3
Bank Active & Row Address		H	X	L	L	H	H	X	V	Row Address		
Read Column Address	Auto Precharge Disable	H	X	L	H	L	H	X	V	L	Column Address (A0~A7)	4,5
	Auto Precharge Enable									H		
Write & Column Address	Auto Precharge Disable	H	X	L	H	L	L	X	V	L	Column Address (A0~A7)	4,5
	Auto Precharge Enable									H		
Burst Stop		H	X	L	H	H	L	X		X		6
Precharge	Bank Selection	H	X	L	L	H	L	X	V	L		4
	Both Banks								X	H		
Clock Suspend or Active Power Down	Entry	H	L	H	X	X	X	X		X		
	Exit			L	H	X	X					
Precharge Power Down Mode	Entry	H	L	H	X	X	X	X		X		
	Exit			L	H	H	X					
DQM		H		X				V		X		7
No Operation Command		H	X	H	X	X	X	X		X		
		H		L	H	H	H					

(V=Valid , X=Don't Care , H=Logic High , L=logic Low)

**Notes :**

- OP Code : Operation Code. A0~A10/AP , BA : Program keys.(@MRS)
- MRS can be issued only at both banks precharge state. A new command can be issued after 2 clock cycle of MRS.
- Auto refresh functions are as same as CBR refresh of DRAM. The automatical precharge without row precharge command is meant by 'Auto'. Auto / self refresh can be issued only at both banks precharge state.
- BA : Bank select address.  
If 'Low' : at read , write , row active and precharge , bank A is selected.  
If 'High' : at read , write , row active and precharge , bank B is selected.  
If A10/AP is 'High' : at row precharge , BA ignored and both banks are selected.
- During burst read or write with auto precharge , new read/write command cannot be issued.  
Another bank read/write command can be issued after the end of burst.  
New row active of the associated bank can be issued at tRP after the end of burst.
- Burst stop command is valid at every burst length.
- DQM sampled at positive going edge of a CLK masks the data-in at the very CLK (Write DQM latency is 0), but makes Hi-Z state the data-out of 2 CLK cycles after. (Read DQM latency is 2)



\*note : 1. All input expect CKE & DQM can be don't care when  $\overline{CS}$  is high at the CLK high going edge.

2. Bank active & read/write are controlled by BA.

BA	Active & Read/Write
0	Bank A
1	Bnak B

3. Enable and disable auto precharge function are controlled by A10/AP in read/wirte command.

A10/AP	BA	Operation
0	0	Disable auto precharge,leave bank A active at end of burst.
	1	Disable auto precharge,leave bank B active at end of burst.
1	0	Enable auto precharge, precharge bank A at end of burst.
	1	Enable auto precharge, precharge bank B at end of burst.

4. A10/AP and BA control bank precharge when precharge command is asserted.

A10/AP	BA	precharge
0	0	Bank A
0	1	Bank B
1	X	Both Banks

**Power Up Sequence**

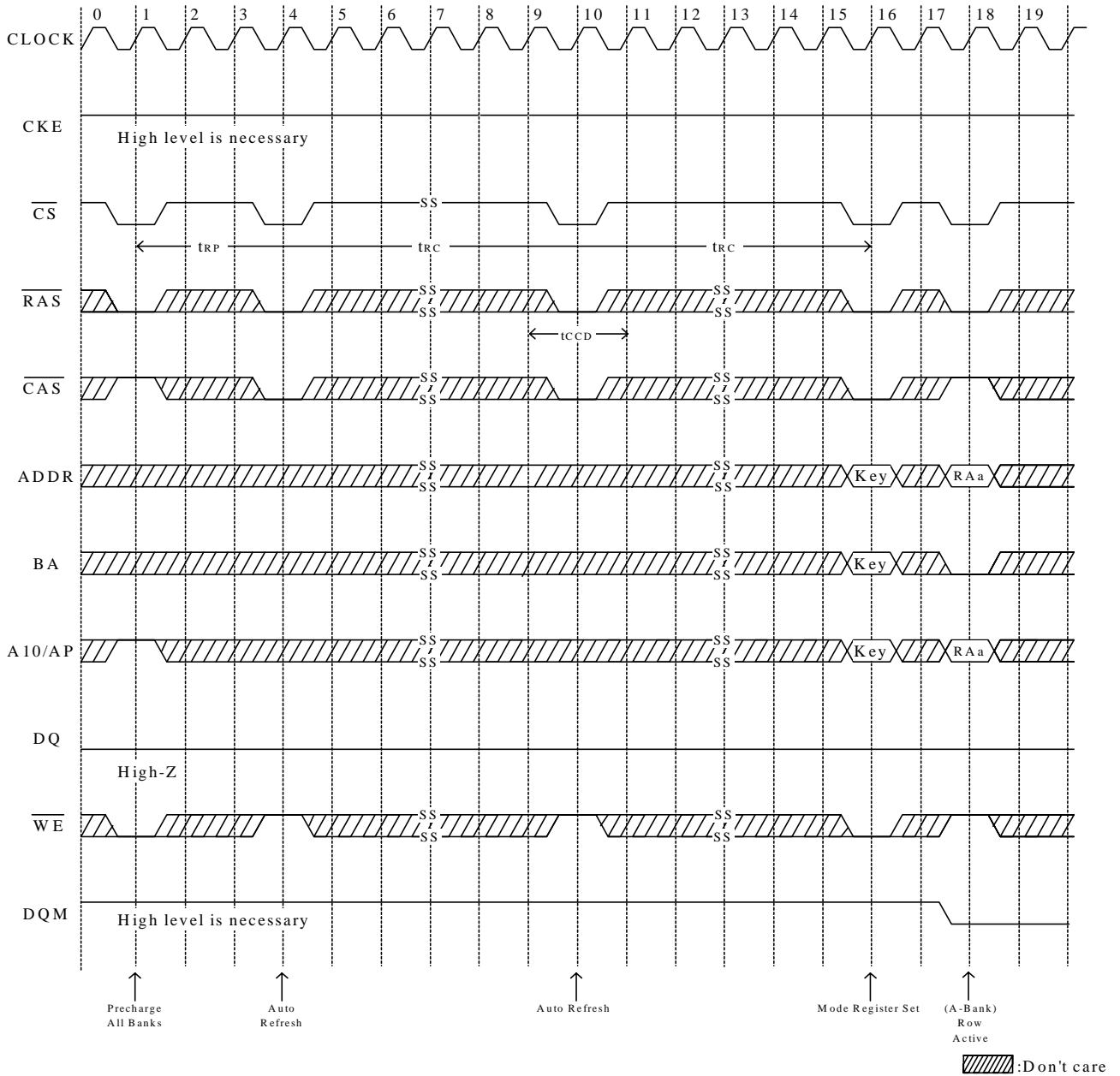



Read & Write Cycle at Same Bank @Burst Length = 4

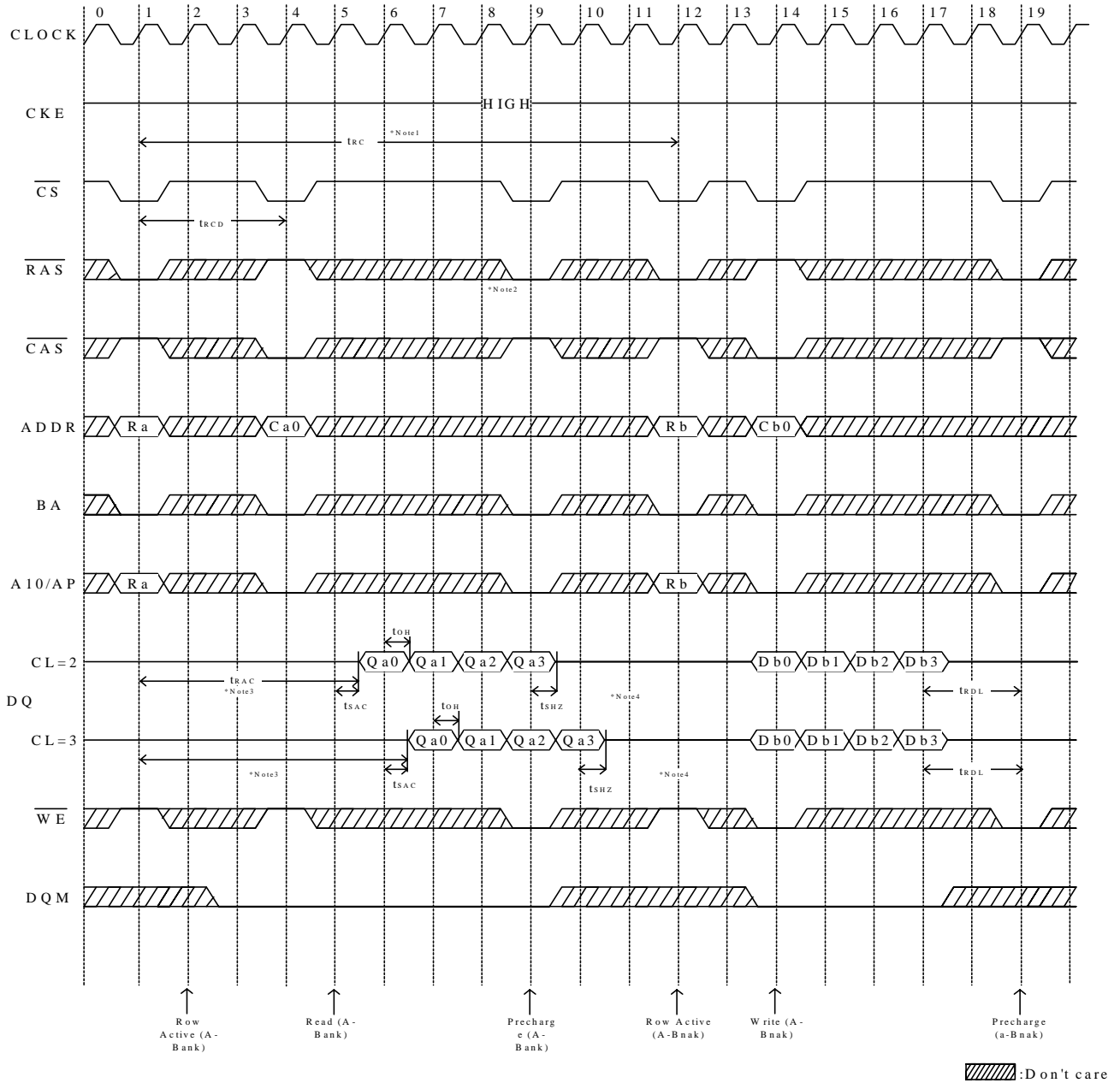

- \*Note : 1. Minimum row cycle times is required to complete internal DRAM operation.  
 2. Row precharge can interrupt burst on any cycle. [CAS Latency-1] number of valid output data is available after Row precharge. Last valid output will be Hi-Z(tSHZ) after the clock.  
 3. Access time from Row active command.  $t_{CC}*(t_{RCD}+CAS\ latency-1)+t_{SAC}$   
 4. Output will be Hi-Z after the end of burst.(1,2,4,8 bit burst)  
 Burst can't end in Full Page Mode.

**Page Read & Write Cycle at Same Bank @ Burst Length = 4**

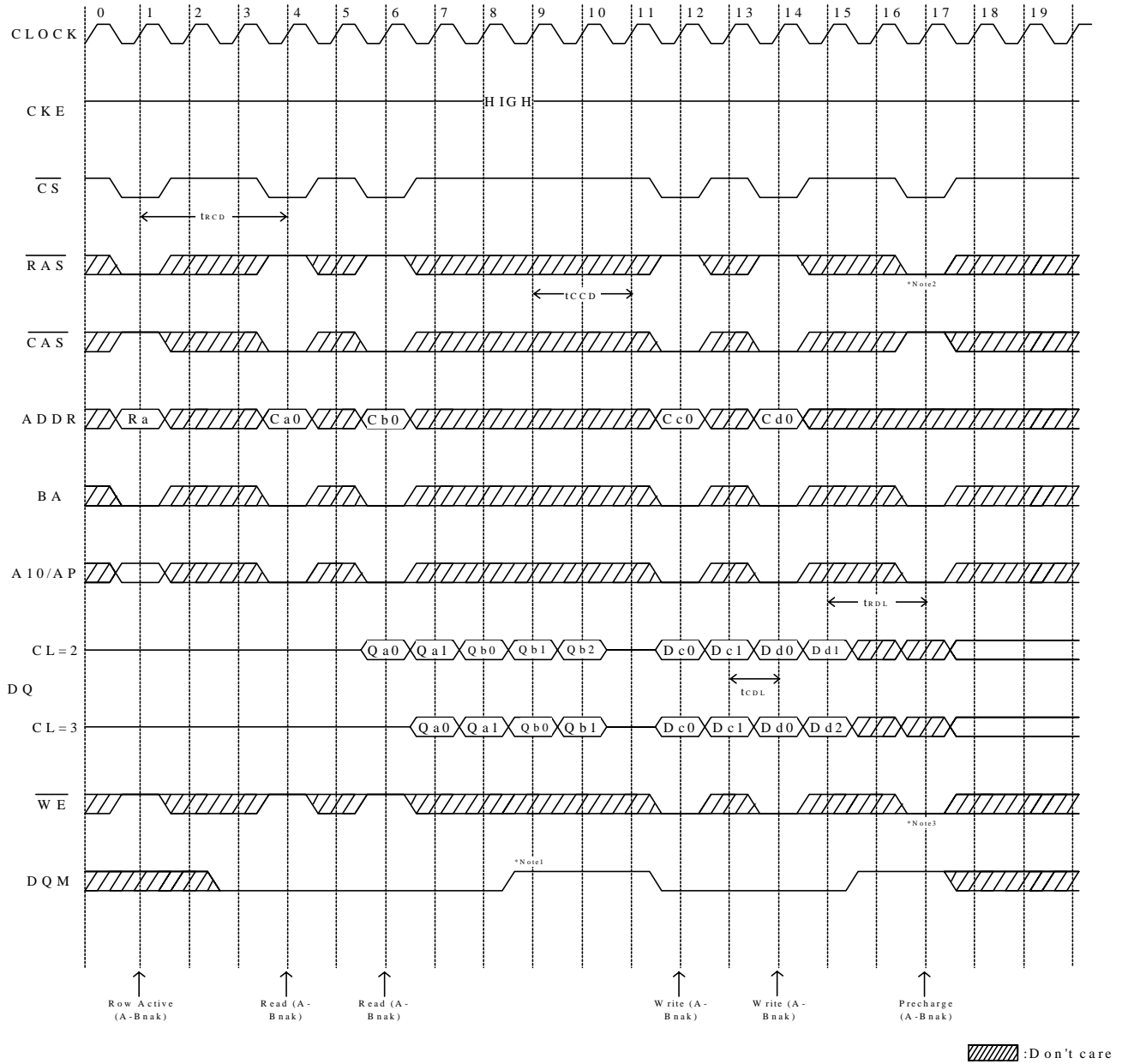

- \*Note : 1. To write data before burst read ends, DQM should be asserted three cycle prior to write command to avoid bus contention.
2. Row precharge will interrupt writing. Last data input,  $t_{rDL}$  before Row precharge, will be written.
3. DQM should mask invalid input data on precharge command cycle when asserting precharge before end of burst. Input data after Row precharge cycle will be masked internally.

**Page Read Cycle at Different Bank @ Burst Length = 4**

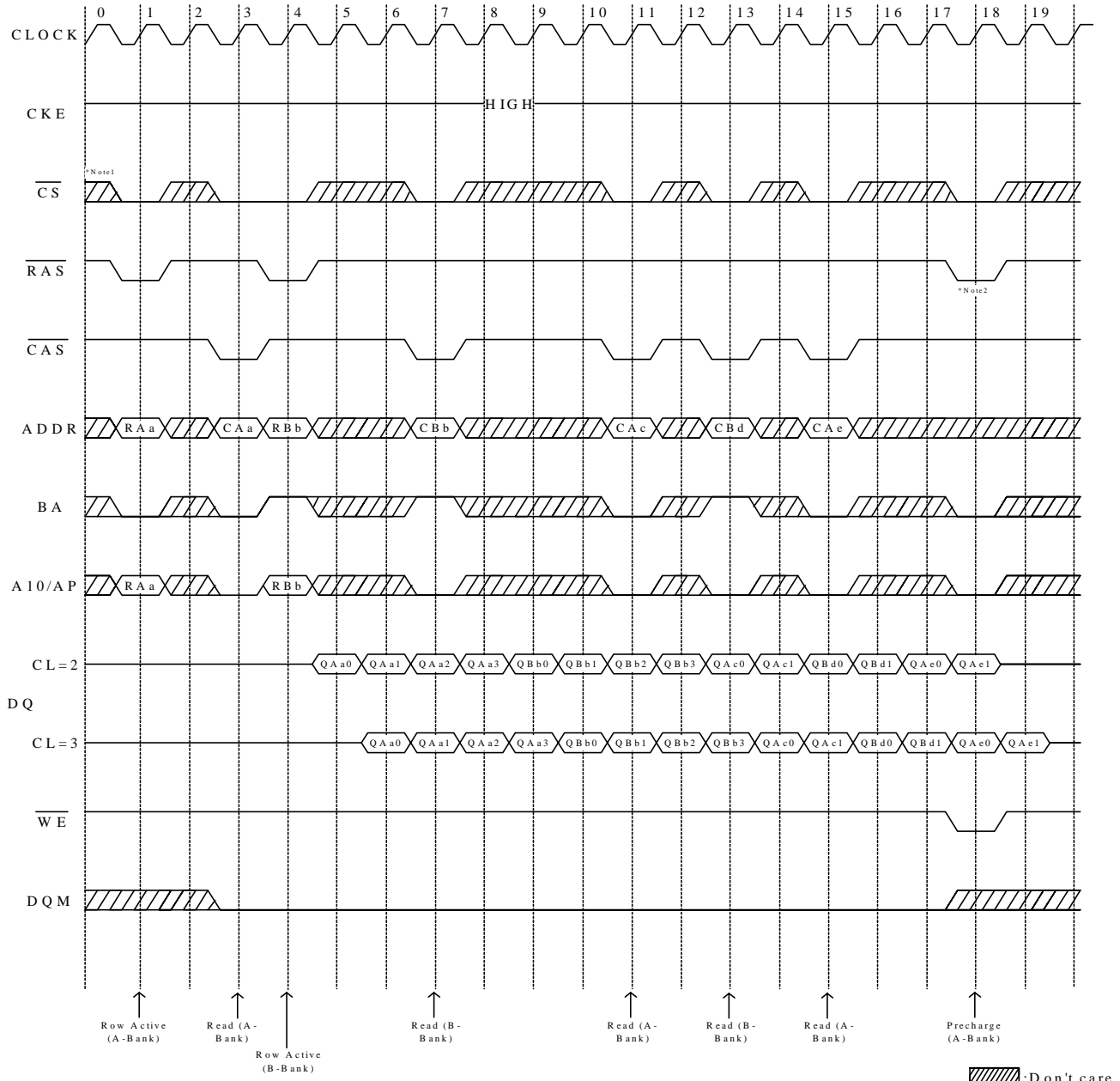

\*Note : 1.  $\overline{CS}$  can be don't cared when  $\overline{RAS}$ ,  $\overline{CAS}$  and  $\overline{WE}$  are high at the clock high going edge.

2. To interrupt a burst read by row precharge, both the read and the precharge banks must be the same.

**Page Write cycle at Different Bank @ Burst Length = 4**

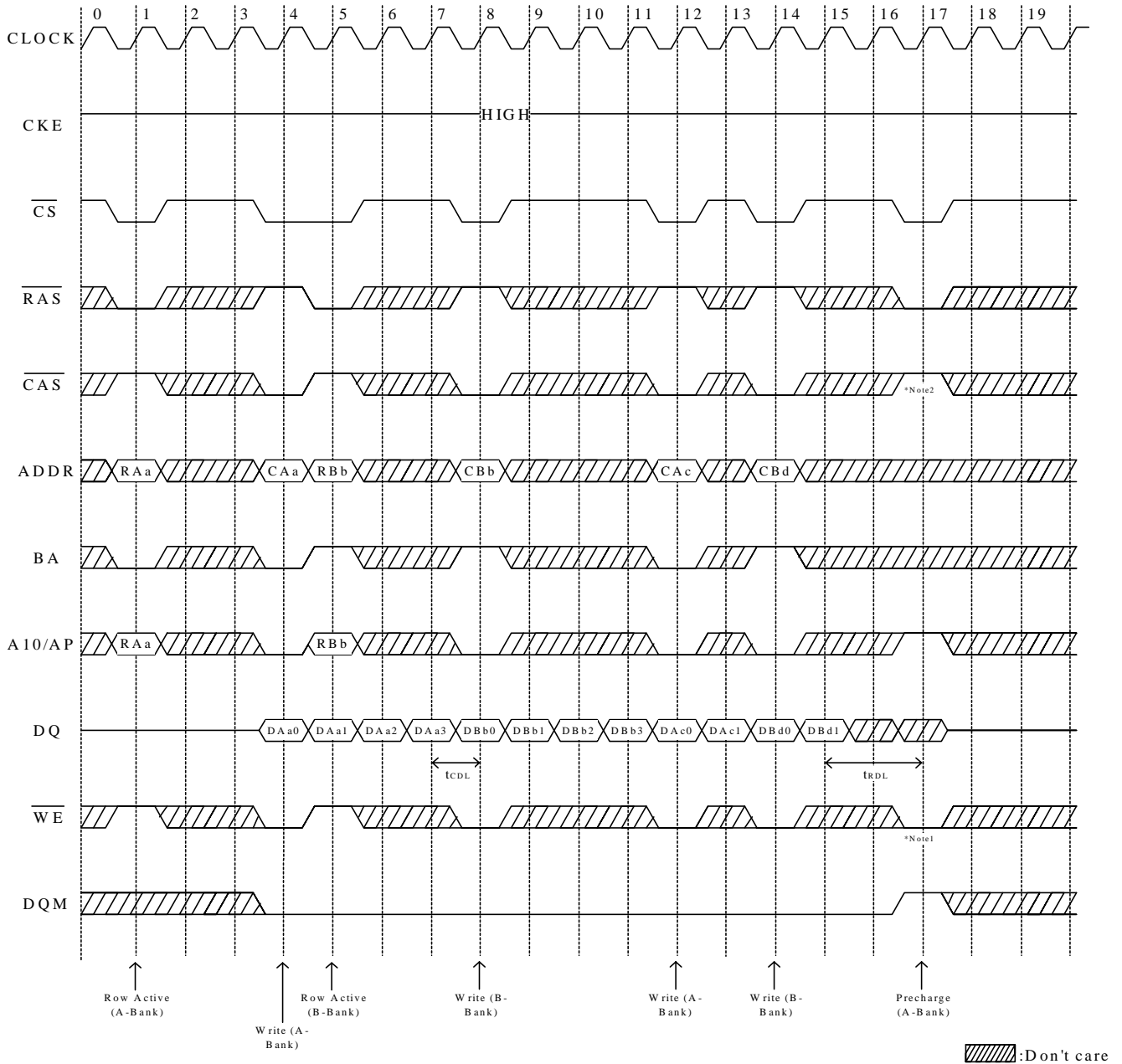

\*Note : 1. To interrupt burst write by row precharge, DQM should be asserted to mask invalid input data.  
 2. To interrupt burst write by row precharge, both the write and the precharge banks must be the same.

**Read & Write Cycle at Different Bank @ Burst Length = 4**

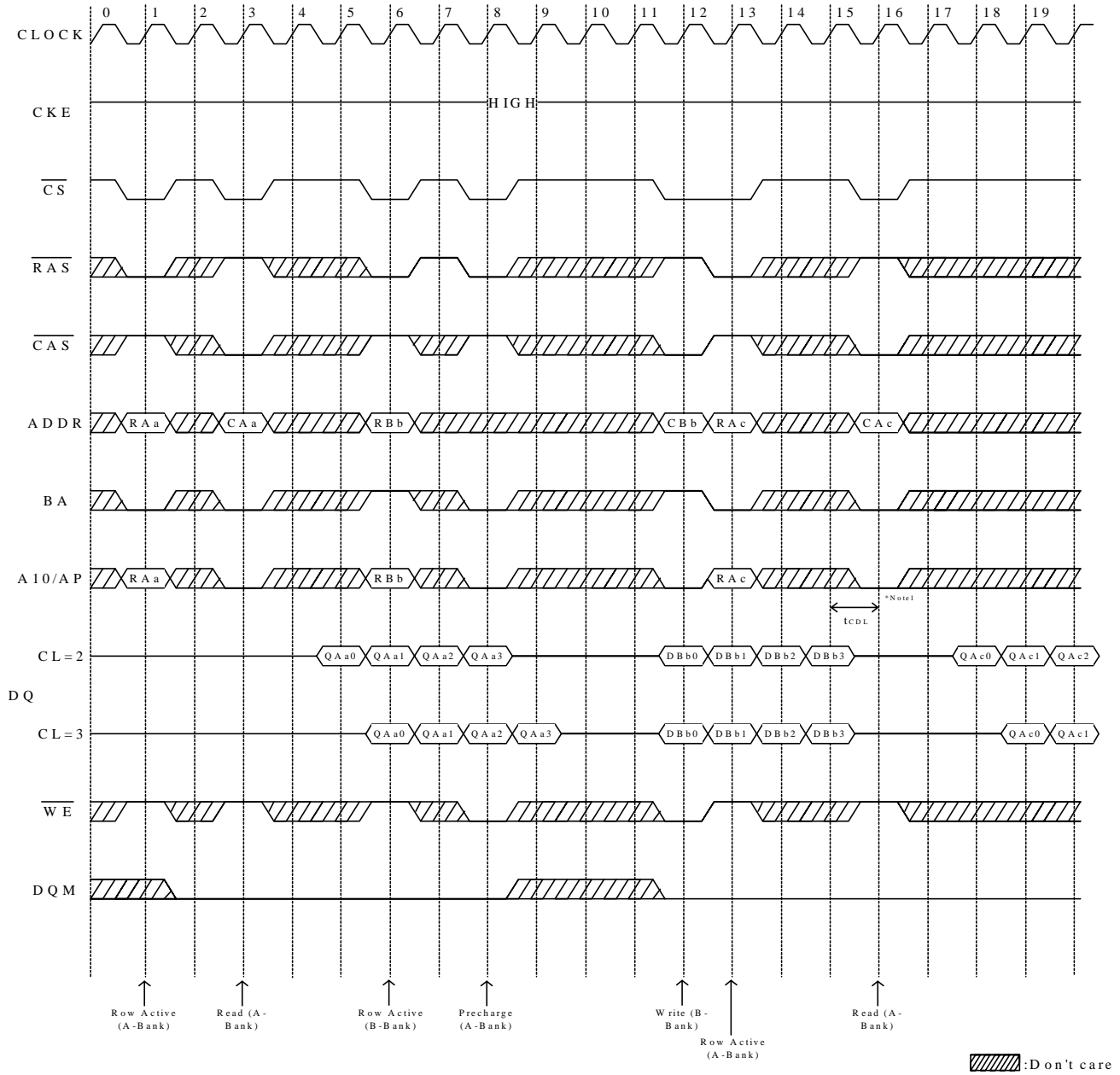

\*Note : 1.  $t_{CDL}$  should be met to complete write.

**Read & Write Cycle with Auto Precharge @ Burst Length = 4**

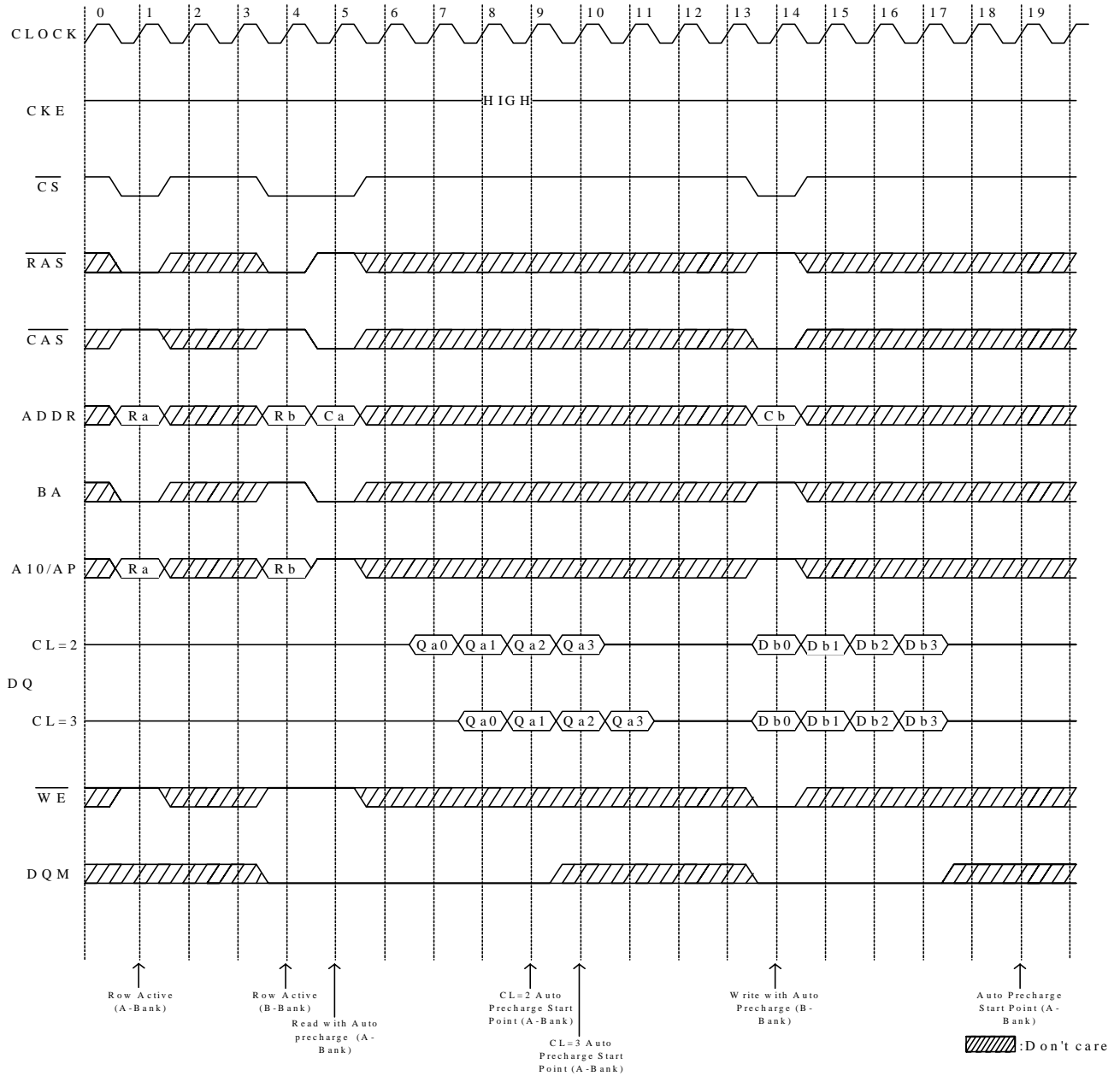

\*Note : 1. tCDL should be controlled to meet minimum tRAS before internal precharge start.  
(In the case of Burst Length = 1 & 2 and BRSW mode)

**Clock suspension & DQM Operation Cycle @ CAS Latency = 2 ,Burst Length = 4**

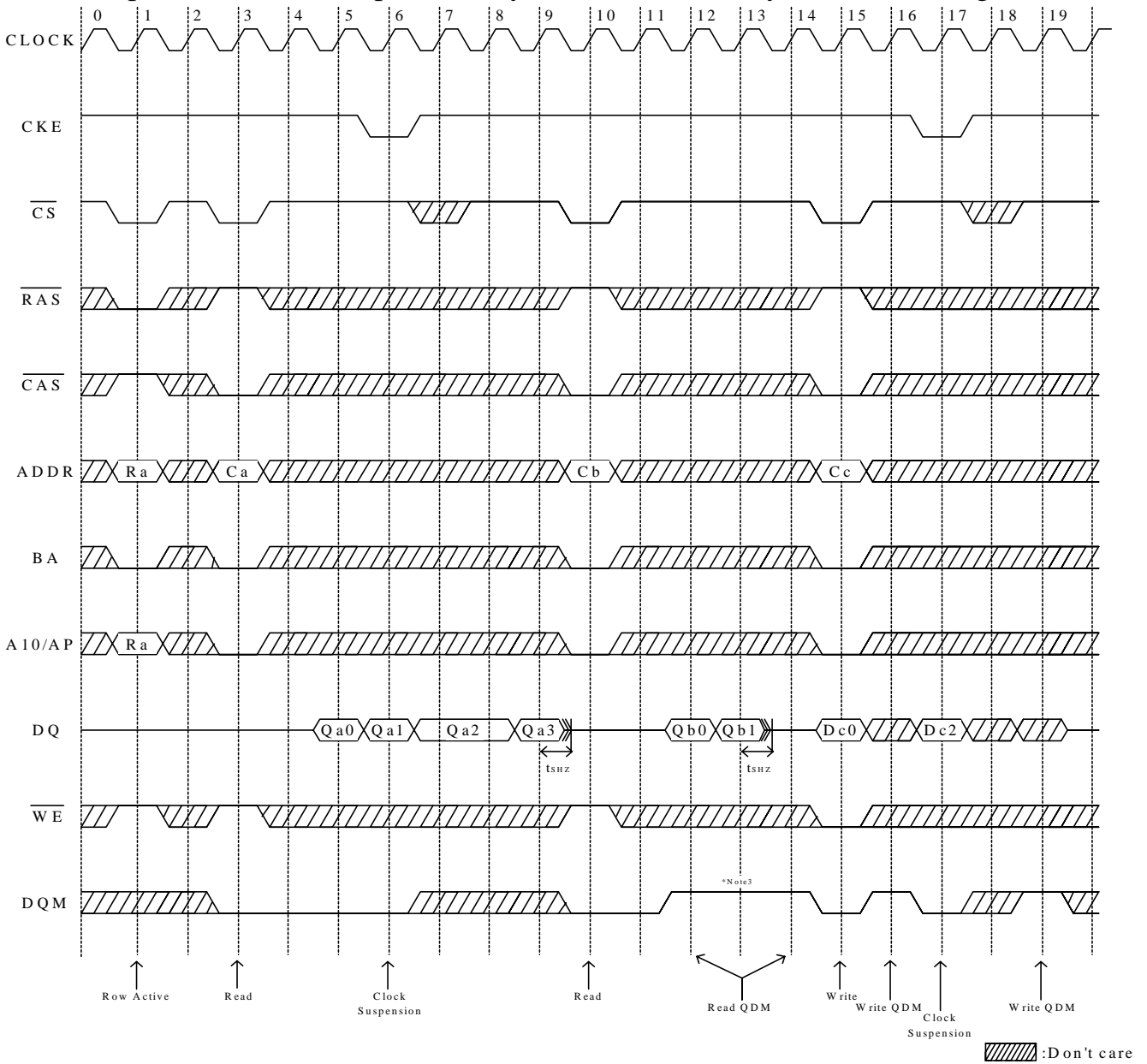

\*Note 1. DQM is needed to prevent bus contention.

Read Interrupted by Precharge Command & Read Burst Stop Cycle @ Burst Length=Full Page

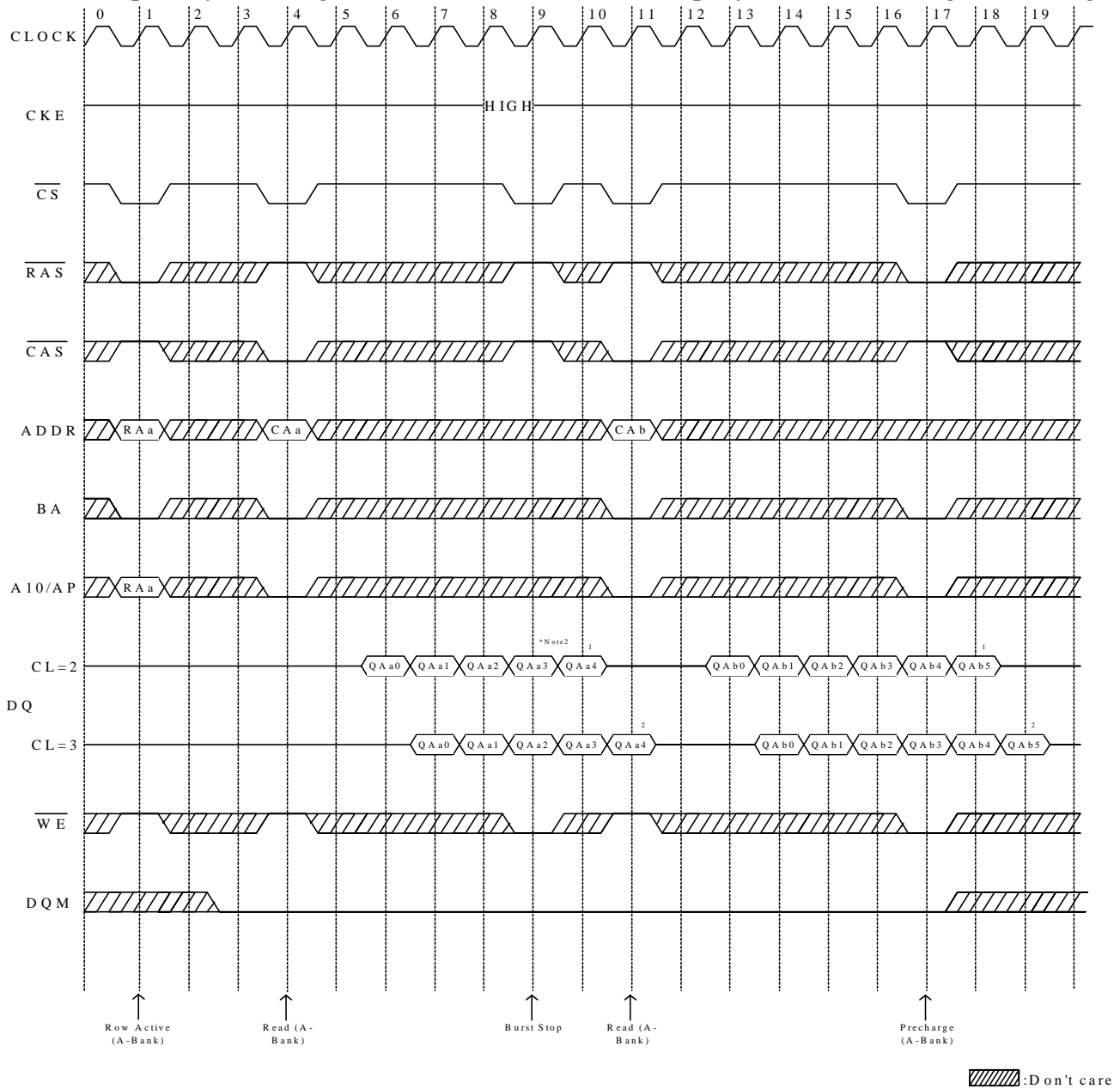

- \*Note :
1. Burst can't end in full page mode, so auto precharge can't issue.
  2. About the valid DQs after burst stop, it is same as the case of  $\overline{\text{RAS}}$  interrupt. Both cases are illustrated above timing diagram. See the table 1,2 on them. But at burst write, burst stop and  $\overline{\text{RAS}}$  interrupt should be compared carefully. Refer the timing diagram of 'Full Page write burst stop cycle'.
  3. Burst stop is valid at every burst length.



Write Interrupted by Prechareg Command & Write Burst Stop Cycle @ Burst Length=Full Page

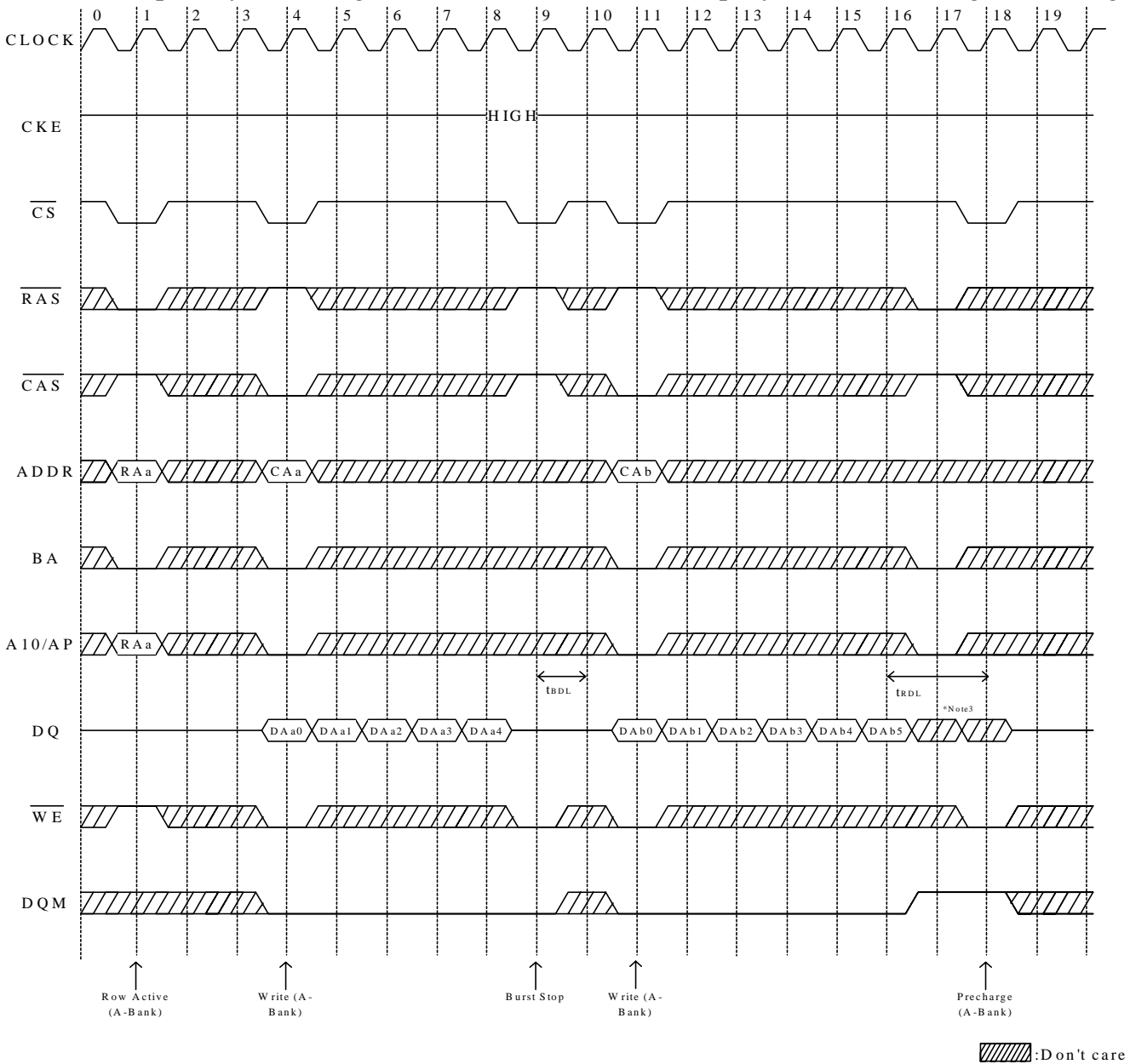

- \*Note : 1. Burst can't end in full page mode, so auto precharge can't issue.  
 2. Data-in at the cycle of interrupted by precharge can not be written into the corresponding memory cell. It is defined by AC parameter of tRDL.  
 DQM at write interrupted by precharge command is needed to prevent invalid write.  
 Input data after Row precharge cycle will be masked internally.  
 3. Burst stop is valid at every burst length.

Burst Read Single bit Write Cycle @ Burst Length = 2

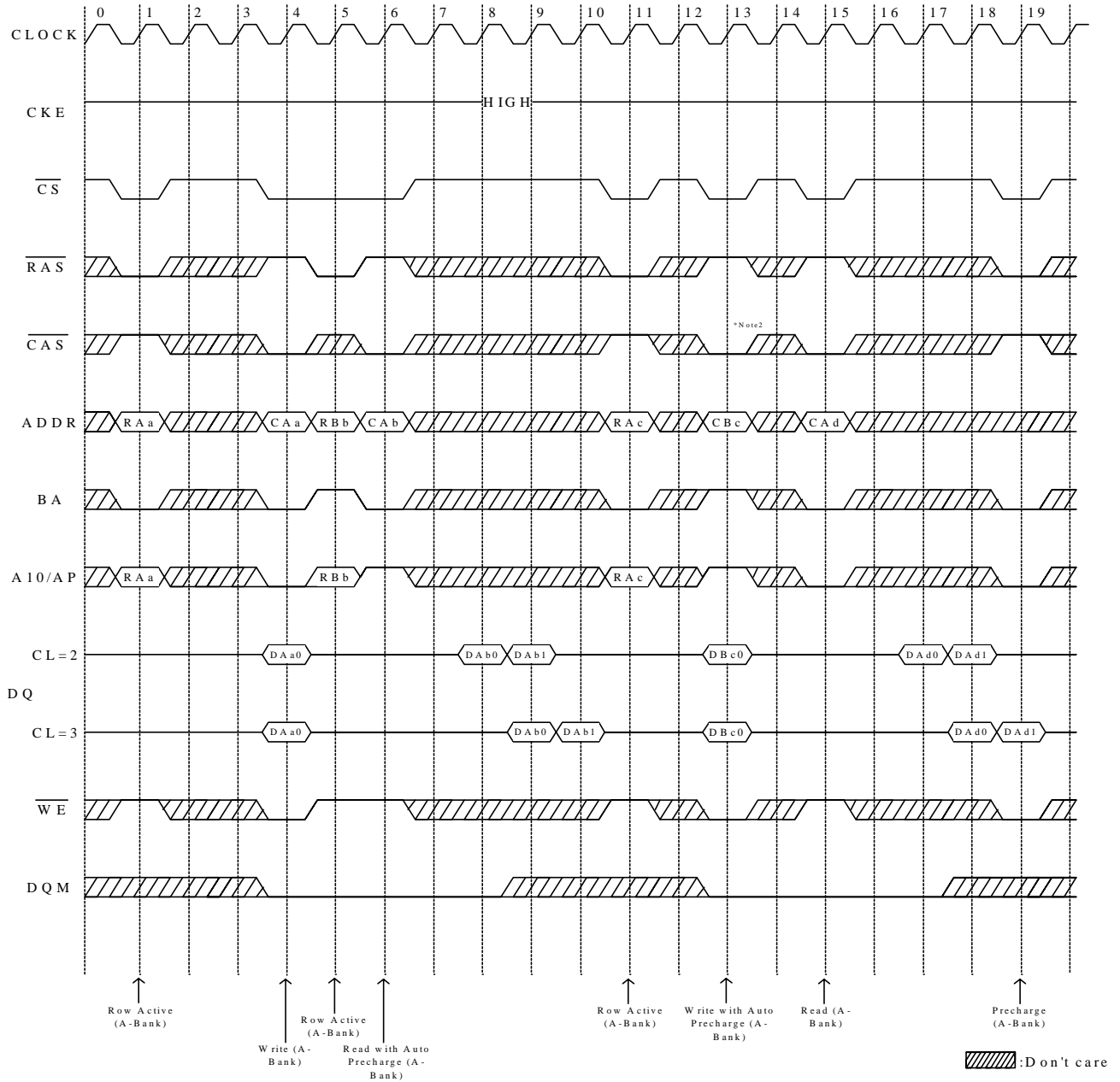

\*Note : 1. BRSW modes is enabled by setting A9 'High' at MRS (Mode Register Set).

At the BRSW Mode, the burst length at write is fixed to '1' regardless of programmed burst length.

2. When BRSW write command with auto precharge is executed, keep it in mind that t<sub>RAS</sub> should not be violated.

Auto precharge is executed at the next cycle of burst-end, so in the case of BRSW write command, the precharge command will be issued after two clock cycle.

**Active/ Precharge Power Down Mode @ CAS latency = 2, Butsr length = 4**

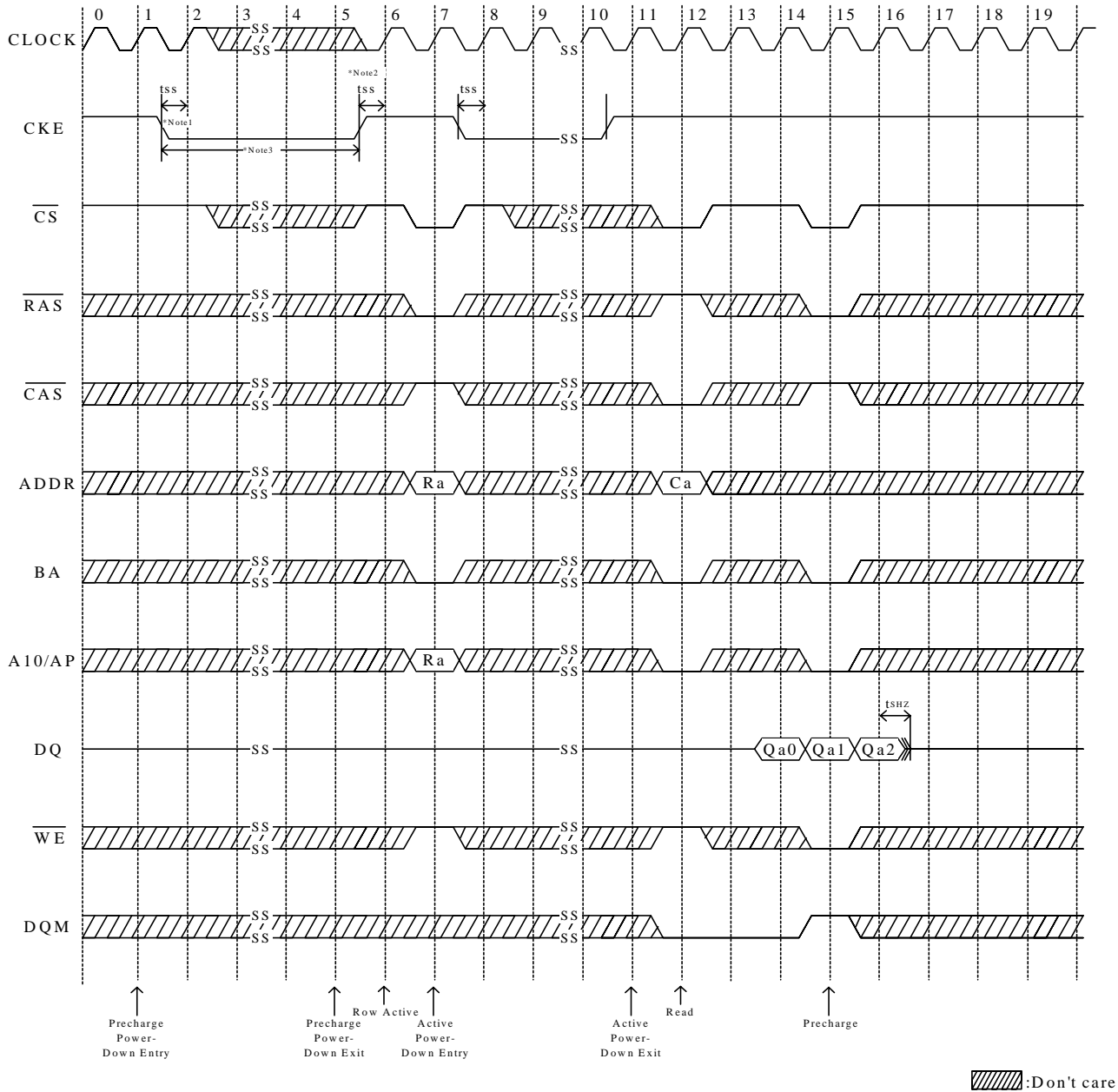

- \*Note : 1. Both banks should be in idle state prior to entering precharge power down mode.
- 2. CKE should be set high at least 1CLK+tSS prior to Row active command.
- 3. Can not violate minimum refresh specification.(32ms)

**Self Refresh Entry & Exit Cycle**

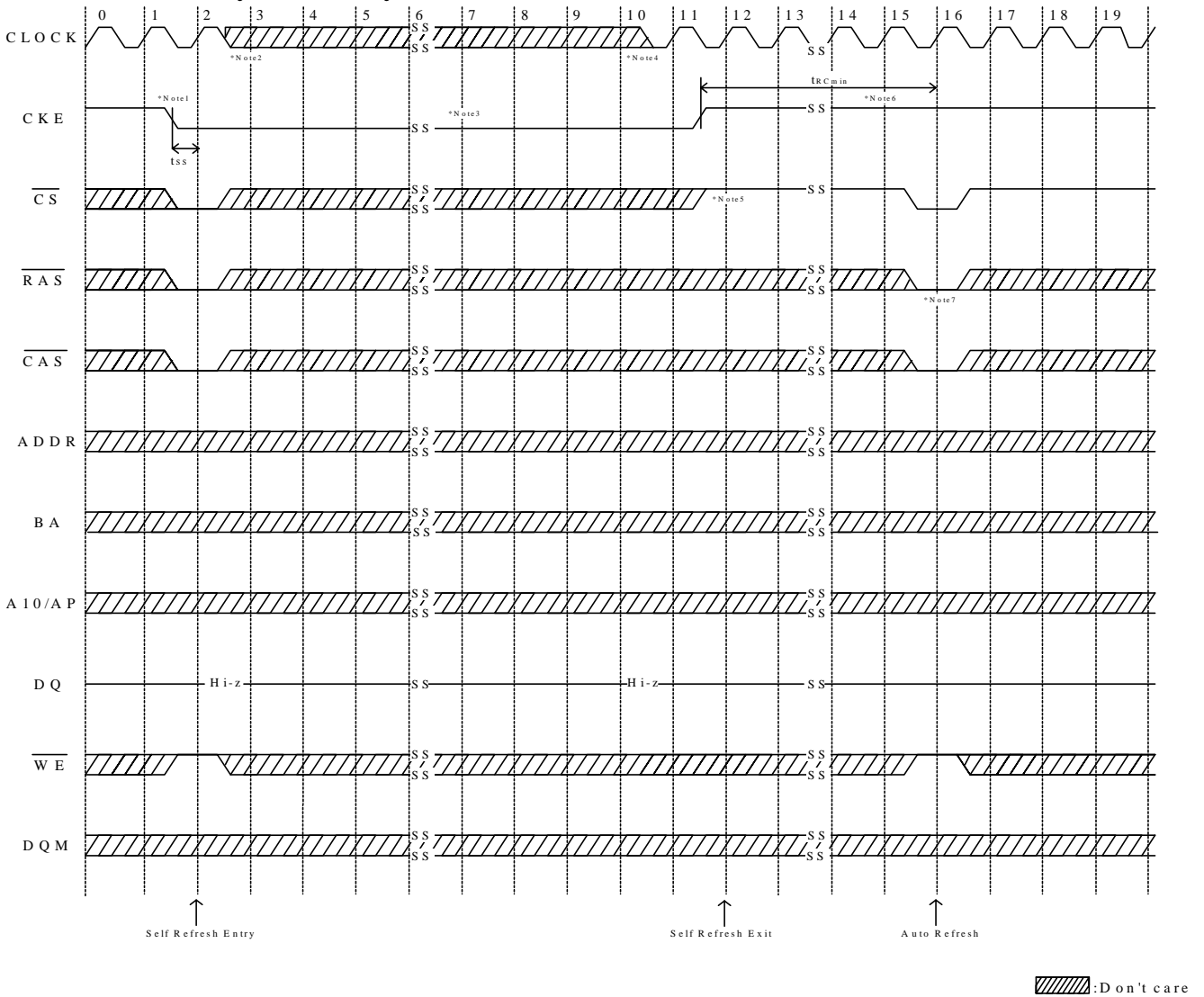

**\*Note : TO ENTER SELF REFRESH MODE**

1.  $\overline{CS}$ ,  $\overline{RAS}$  &  $\overline{CAS}$  with  $\overline{CKE}$  should be low at the same clock cycle.
2. After 1 clock cycle, all the inputs including the system clock can be don't care except for CKE.
3. The device remains in self refresh mode as long as CKE stays 'Low'.

Cf.) Once the device enters self refresh mode, minimum t<sub>RAS</sub> is required before exit from self refresh.

**TO EXIT SELF REFRESH MODE**

4. System clock restart and be stable before returning CKE high.
5.  $\overline{CS}$  starts from high.
6. Minimum t<sub>RC</sub> is required after CKE going high to complete self refresh exit.
7. 2K cycle of burst auto refresh is required before self refresh entry and after self refresh exit if the system uses burst refresh.

**Mode Register Set Cycle**

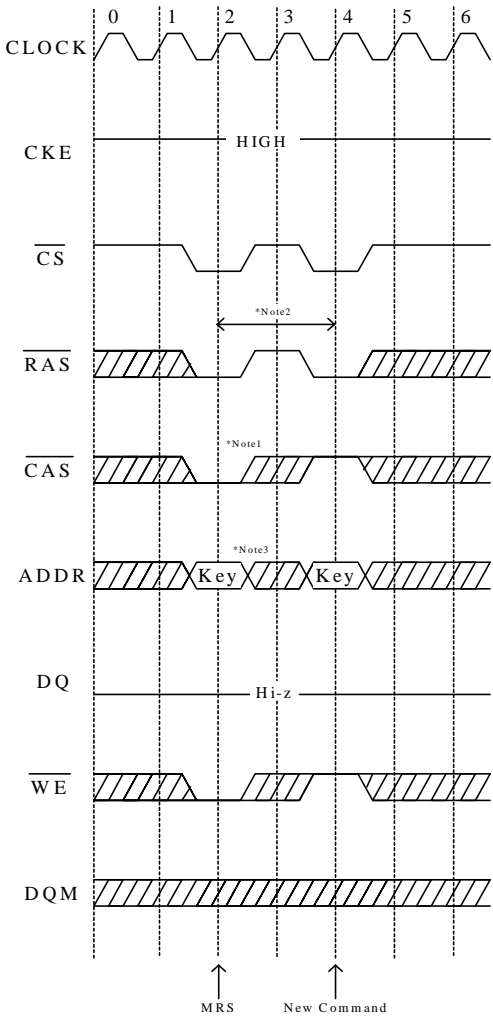

**Auto Refresh Cycle**

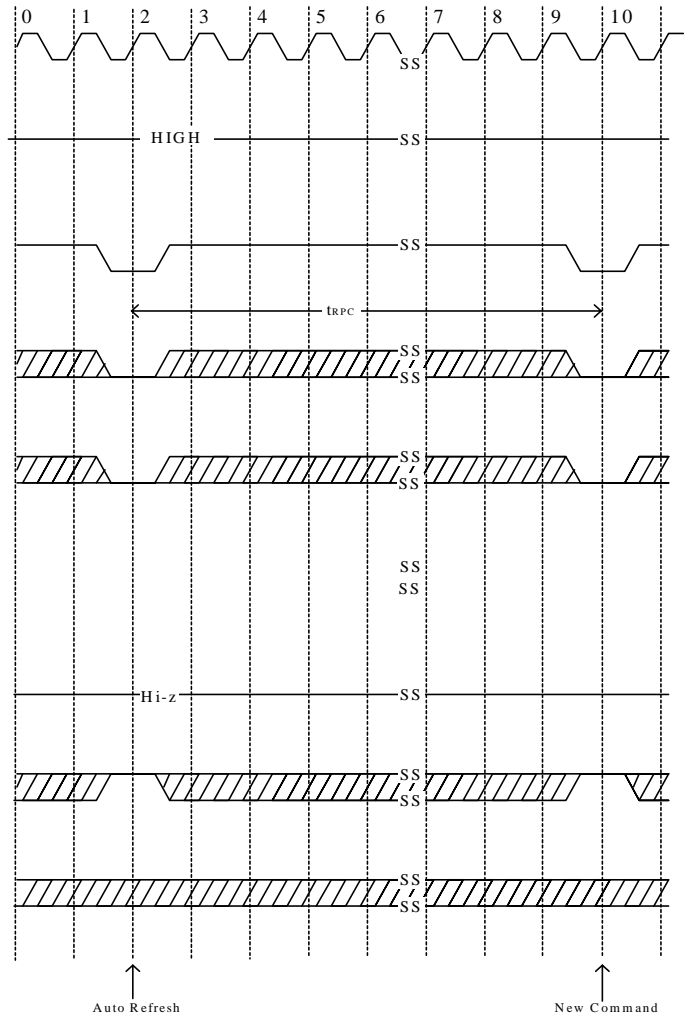

: Don't care

\*Both banks precharge should be completed before Mode Register Set cycle and auto refresh cycle.

**MODE REGISTER SET CYCLE**

- \*Note : 1.  $\overline{CS}$ ,  $\overline{RAS}$ ,  $\overline{CAS}$  &  $\overline{WE}$  activation at the same clock cycle with address key will set internal mode register.
2. Minimum 2 clock cycles should be met before new  $\overline{RAS}$  activation.
3. Please refer to Mode Register Set table.

**PACKAGE DIMENSIONS**  
**50 LEAD TSOPII (400 mil)**

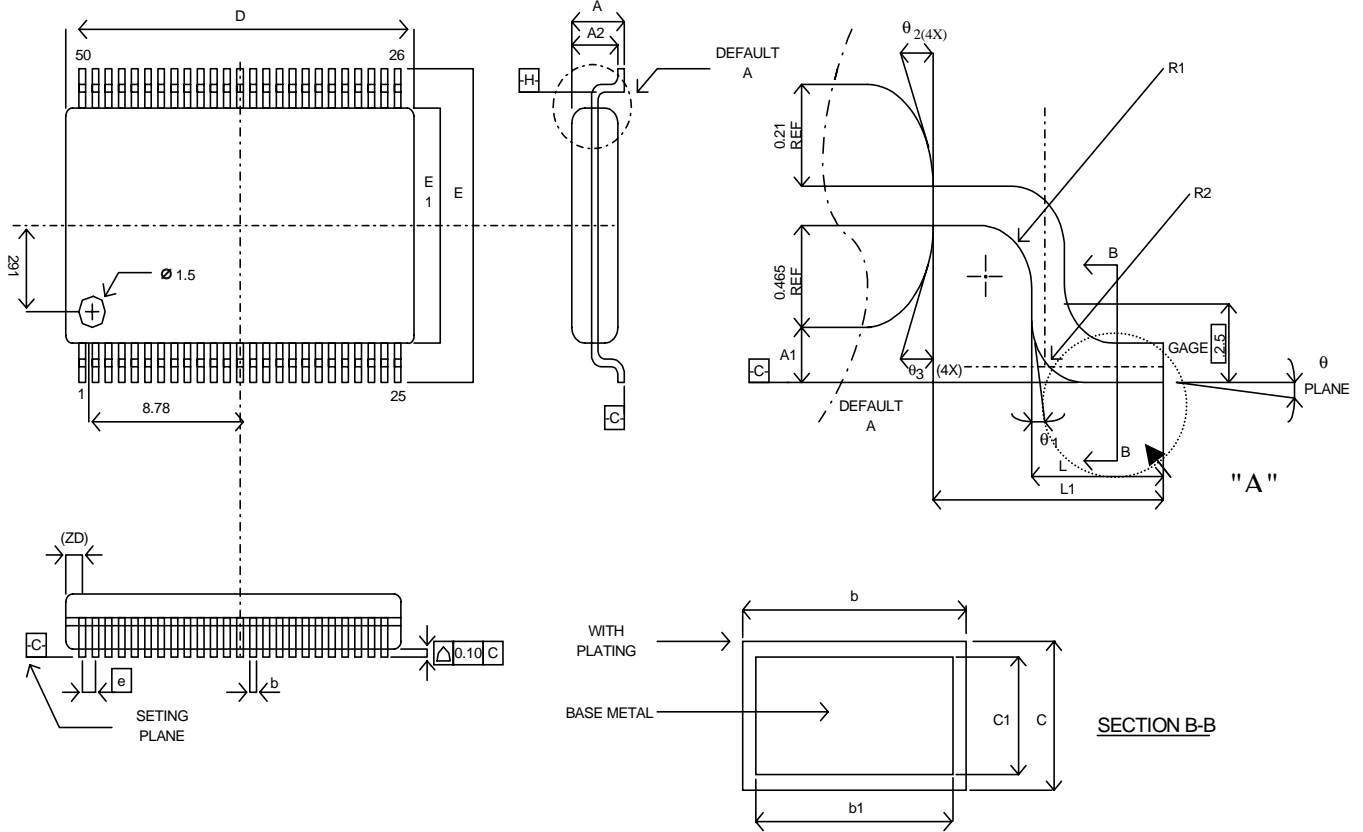

Symbol	Dimension in mm			Dimension in inch		
	Min	Nom	Max	Min	Nom	Max
A	-	-	1.20	-	-	0.047
A1	0.05	0.10	0.15	0.002	0.004	0.006
A2	0.95	1.00	1.05	0.037	0.039	0.041
b	0.30	-	0.45	0.012	-	0.018
b1	0.30	0.35	0.40	0.012	0.014	0.016
c	0.12	-	0.21	0.005	-	0.008
c1	0.10	0.127	0.16	0.004	0.005	0.006
D	20.82	20.95	21.08	0.820	0.825	0.830
ZD	0.875 REF			0.034 REF		
E	11.56	11.76	11.96	0.455	0.463	0.471
E1	10.03	10.16	10.29	0.394	0.400	0.405
L	0.40	0.50	0.60	0.016	0.020	0.024
L1	0.80 REF			0.031 REF		
e	0.80 BSC			0.031 BSC		
R1	0.12	-	-	0.005	-	-
R2	0.12	-	0.25	0.005	-	0.010
θ	0	-	8	0	-	8
θ1	0	-	-	0	-	-
θ2	10	15	20	10	15	20
θ3	10	15	20	10	15	20