

Powerex, Inc., 200 Hillis Street, Youngwood, Pennsylvania 15697-1800 (412) 925-7272
 Powerex, Europe, S.A. 428 Avenue G. Durand, BP107, 72003 Le Mans, France (43) 41.14.14

Phase Control SCR
 1800 Amperes Average
 2200 Volts

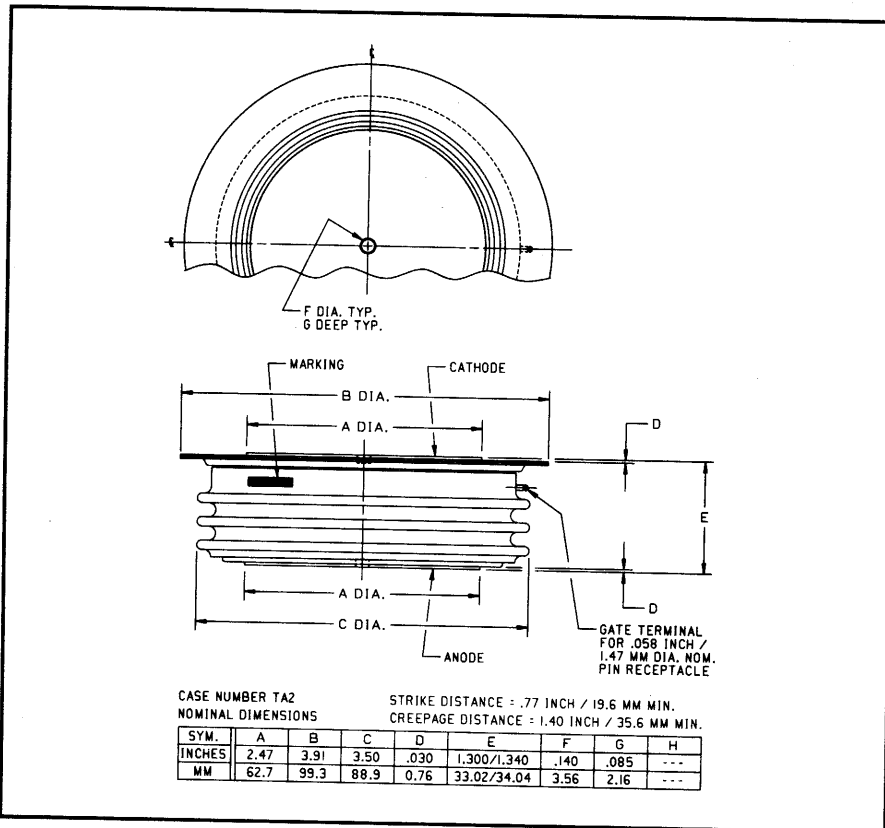

TA20 1800A (Outline Drawing)

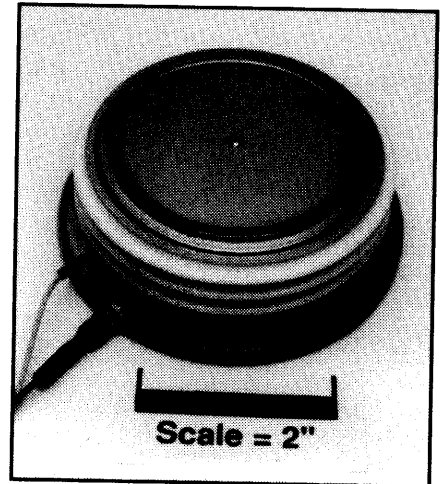

TA20 1800A Phase Control SCR
 1800 Amperes Average, 2200 Volts

Description:

Powerex Silicon Controlled Rectifiers (SCR) are designed for phase control applications. These are all-diffused, Press-Pak, hermetic Pow-R-Disc devices employing the field proven amplifying gate.

Features:

- Low On-State Voltage
- High di/dt Capability
- High dv/dt Capability
- Hermetic Packaging
- Excellent Surge I^2t Ratings

Applications:

- Power Supplies
- Motor Control

Ordering Information:

Select the complete 12 digit part number you desire from the table below.

| Type | Voltage | Current | Turn-off | Gate Current | Lead Code |
|------|------------------------------|------------------|----------------------------|------------------|-----------|
| | V_{DRM}/V_{RRM} (Volts) | $I_T(av)$ (A) | t_q (μ sec) | I_{GT} (mA) | |
| TA20 | 02 through 22 | 18 | 0 | 3 | DH |
| | 200V through 2200V | 1800A | 250 μ sec (Typical) | 200mA | 12" |



Powerex, Inc., 200 Hillis Street, Youngwood, Pennsylvania 15697-1800 (412) 925-7272
 Powerex, Europe, S.A. 428 Avenue G. Durand, BP107, 72003 Le Mans, France (43) 41.14.14

TA20 1800A
Phase Control SCR
 1800 Amperes Average, 2200 Volts

Absolute Maximum Ratings

| Characteristics | Symbol | TA20 1800A | Units |
|---|--------------|--------------------|--------------------|
| Non-repetitive Transient Peak Reverse Voltage | V_{RSM} | $V_{RRM} + 100V$ | Volts |
| RMS On-state Current, $T_C = 85^\circ C$ | $I_{T(rms)}$ | 2820 | Amperes |
| Average Current 180° Sine Wave, $T_C = 85^\circ C$ | $I_{T(av)}$ | 1800 | Amperes |
| RMS On-state Current, $T_C = 55^\circ C$ | $I_{T(rms)}$ | 4200 | Amperes |
| Average Current 180° Sine Wave, $T_C = 55^\circ C$ | $I_{T(av)}$ | 2675 | Amperes |
| Peak One Cycle Surge On-state Current (Non-repetitive) 60Hz | I_{tsm} | 40000 | Amperes |
| Peak One Cycle Surge On-state Current (Non-repetitive) 50Hz | I_{tsm} | 36500 | Amperes |
| Critical Rate-of-rise of On-state Current (Non-repetitive) | di/dt | 400 | A/ μ sec |
| Critical Rate-of-rise of On-state Current (Repetitive) | di/dt | 150 | A/ μ sec |
| I^2t (for Fusing) for One Cycle, 60Hz | I^2t | 6.67×10^6 | A ² sec |
| Peak Gate Power Dissipation | P_{GM} | 16 | Watts |
| Average Gate Power Dissipation | $P_{G(av)}$ | 3 | Watts |
| Operating Temperature | T_j | -40 to +125°C | °C |
| Storage Temperature | T_{stg} | -40 to +150°C | °C |
| Approximate Weight | | 2.1 | lb. |
| | | 950 | g |
| Mounting Force | | 9000 to 11000 | lb. |
| | | 4100 to 5000 | kg. |



Powerex, Inc., 200 Hillis Street, Youngwood, Pennsylvania 15697-1800 (412) 925-7272
 Powerex, Europe, S.A. 428 Avenue G. Durand, BP107, 72003 Le Mans, France (43) 41.14.14

TA20 1800A
 Phase Control SCR
 1800 Amperes Average, 2200 Volts

Electrical Characteristics, $T_j = 25^\circ\text{C}$ Unless Otherwise Specified

| Characteristics | Symbol | Test Conditions | Min. | Typ. | Max. | Units |
|---|-------------|--|------|------|--------------------------|--------------------------|
| Repetitive Peak Reverse Leakage Current | I_{RRM} | $T_j = 125^\circ\text{C}, V_R = V_{RRM}$ | | | 100 | mA |
| Repetitive Peak Forward Leakage Current | I_{DRM} | $T_j = 125^\circ\text{C}, V_D = V_{DRM}$ | | | 100 | mA |
| Peak On-state Voltage | V_{TM} | $I_{TM} = 3000\text{A Peak}$ Duty Cycle < 0.1% | | | 1.45 | Volts |
| Threshold Voltage, Low-level | $V_{(TO)1}$ | $T_j = 125^\circ\text{C}, I = 15\%, I_T(\text{av})$ to $\pi I_T(\text{av})$ | | | 0.71870 | Volts |
| Slope Resistance, Low-level | r_{T1} | | | | 0.1669 | $\text{m}\Omega$ |
| Threshold Voltage, High-level | $V_{(TO)2}$ | $T_j = 125^\circ\text{C}, I = \pi I_T(\text{av})$ to I_{TSM} | | | 0.97647 | Volts |
| Slope Resistance, High-level | r_{T2} | | | | 0.1215 | $\text{m}\Omega$ |
| V_{TM} Coefficients, Low-level | | $T_j = 125^\circ\text{C}, I = 15\% I_T(\text{av})$ to $\pi I_T(\text{av})$ | | | | |
| | | | | | $A_1 = 1.0791$ | |
| | | | | | $B_1 = -0.12551$ | |
| | | | | | $C_1 = 3.874\text{E-}06$ | |
| | | | | | $D_1 = 0.02151$ | |
| V_{TM} Coefficients, High-level | | $T_j = 125^\circ\text{C}, I = \pi I_T(\text{av})$ to I_{TSM} | | | | |
| | | | | | $A_2 = -6.7846$ | |
| | | | | | $B_2 = 1.1619$ | |
| | | | | | $C_2 = 1.858\text{E-}04$ | |
| | | | | | $D_2 = -0.03560$ | |
| Typical Turn-on Time | t_{on} | $I_T = 1000\text{A}, V_D = 1500\text{V}$ | | 4 | | μsec |
| Typical Turn-off Time | t_q | $T_j = 125^\circ\text{C}, I_T = 250\text{A},$ $di/dt = 50\text{A}/\mu\text{sec}$ Reapplied $dv/dt = 20\text{V}/\mu\text{sec}$ Linear to 80% V_{DRM} | | 250 | | μsec |
| Minimum Critical dv/dt - Exponential to V_{DRM} | dv/dt | $T_j = 125^\circ\text{C}$ | 300 | | | $\text{V}/\mu\text{sec}$ |
| Gate Trigger Current | I_{GT} | $T_j = 25^\circ\text{C}, V_D = 12\text{V}$ | | | 200 | mA |
| Gate Trigger Voltage | V_{GT} | $T_j = 25^\circ\text{C}, V_D = 12\text{V}$ | | | 3.0 | Volts |
| Non-Triggering Gate Voltage | V_{GDM} | $T_j = 125^\circ\text{C}, V_D = V_{DRM}$ | | | 0.15 | Volts |
| Peak Forward Gate Current | I_{GTM} | | | | 4 | A |
| Peak Reverse Gate Voltage | V_{GRM} | | | | 5 | Volts |

Thermal Characteristics

Maximum Thermal Resistance, Double Sided Cooling

| | | | | |
|------------------|-------------------|--|-------|---------------------------|
| Junction-to-Case | $R_{\theta(j-c)}$ | | 0.015 | $^\circ\text{C}/\text{W}$ |
| Case-to-Sink | $R_{\theta(c-s)}$ | | 0.007 | $^\circ\text{C}/\text{W}$ |

Powerex, Inc., 200 Hillis Street, Youngwood, Pennsylvania 15697-1800 (412) 925-7272
 Powerex, Europe, S.A. 428 Avenue G. Durand, BP107, 72003 Le Mans, France (43) 41.14.14

TA20 1800A
Phase Control SCR
 1800 Amperes Average, 2200 Volts

Maximum On-State Forward Voltage Drop
 (T_J = 125 °C)

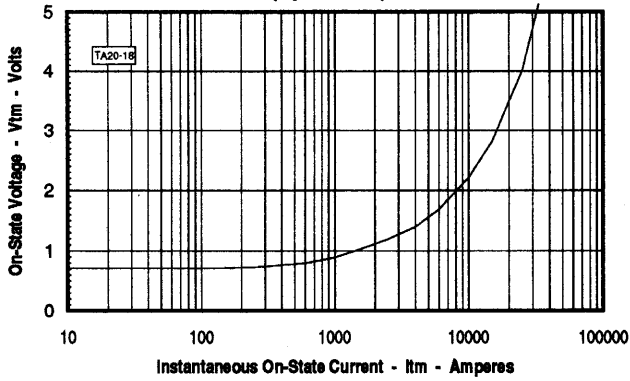

Maximum Transient Thermal Impedance
 (Junction to Case)

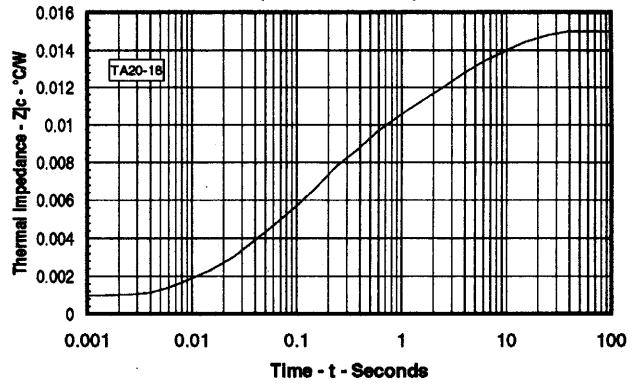

Maximum On-State Power Dissipation
 (Sinusoidal Waveform)

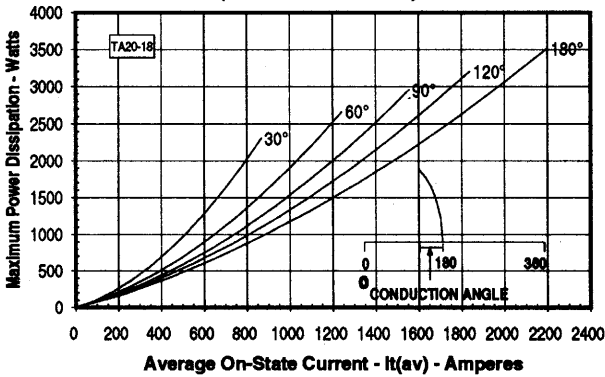

Maximum Allowable Case Temperature
 (Sinusoidal Waveform)

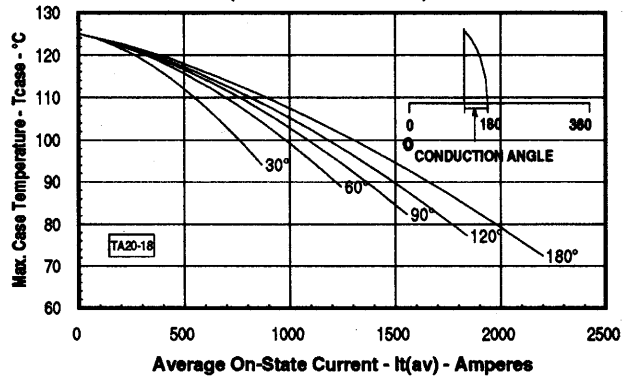

Maximum On-State Power Dissipation
 (Rectangular Waveform)

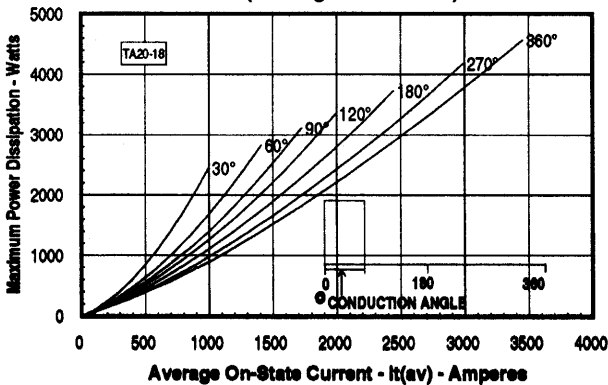

Maximum Allowable Case Temperature
 (Rectangular Waveform)

