

TOSHIBA BIPOLAR LINEAR INTEGRATED CIRCUIT SILICON MONOLITHIC

**TA78M05SB, TA78M06SB, TA78M08SB, TA78M09SB, TA78M10SB
TA78M12SB, TA78M15SB, TA78M18SB, TA78M20SB, TA78M24SB**

**0.5A THREE TERMINAL POSITIVE VOLTAGE REGULATORS
5V, 6V, 8V, 9V, 10V, 12V, 15V, 18V, 20V, 24V**

The TA78M × SB series of fixed-voltage monolithic integrated circuit voltage regulators is designed for a wide range of applications. These regulators employ internal current-limiting, thermal-shutdown and safe-area compensation, making them essentially indestructible. One of these regulators can driver up to 0.5A of output current.

FEATURES

- Suitable for CMOS, TTL and the other Digital IC's Power Supply.
- Output Current in Excess of 0.5A
- Internal Thermal Overload Protection
- Internal Short Circuit Current Limiting
- Package in the Plastic Case TPL ($P_D = 1.8W$)

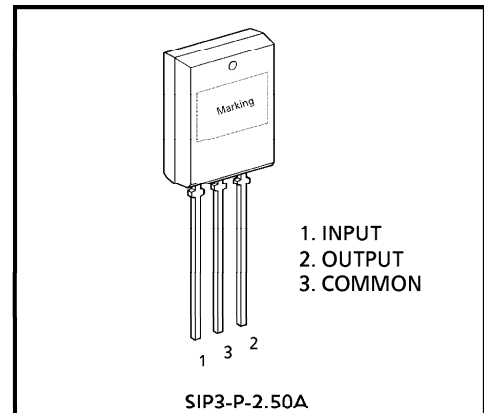

Weight : 1.5g (Typ.)

EQUIVALENT CIRCUIT

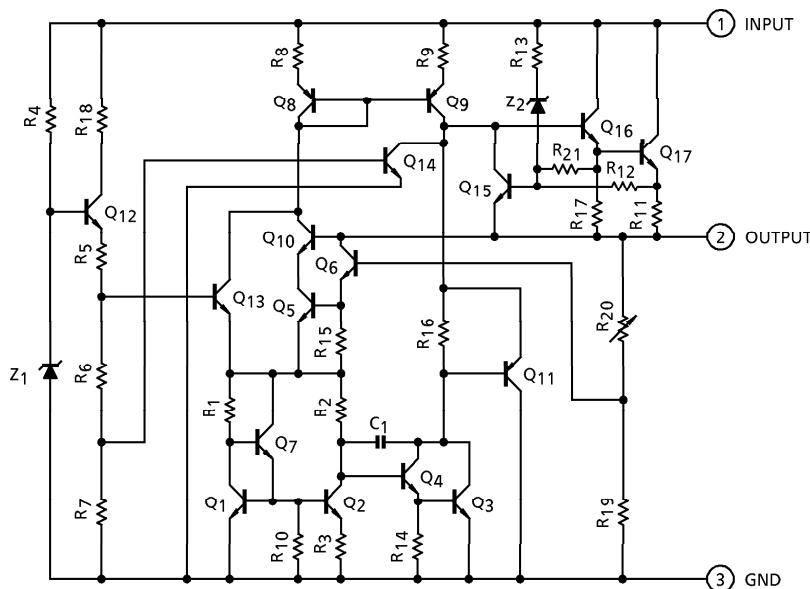

961001EBA2

● TOSHIBA is continually working to improve the quality and the reliability of its products. Nevertheless, semiconductor devices in general can malfunction or fail due to their inherent electrical sensitivity and vulnerability to physical stress. It is the responsibility of the buyer, when utilizing TOSHIBA products, to observe standards of safety, and to avoid situations in which a malfunction or failure of a TOSHIBA product could cause loss of human life, bodily injury or damage to property. In developing your designs, please ensure that TOSHIBA products are used within specified operating ranges as set forth in the most recent products specifications. Also, please keep in mind the precautions and conditions set forth in the TOSHIBA Semiconductor Reliability Handbook.

MAXIMUM RATINGS (Ta = 25°C)

CHARACTERISTIC		SYMBOL	RATING	UNIT
Input Voltage	TA78M05SB	V _{IN}	35	V
	TA78M06SB			
	TA78M08SB			
	TA78M09SB			
	TA78M10SB			
	TA78M12SB			
	TA78M15SB			
	TA78M18SB		40	
	TA78M20SB			
	TA78M24SB			
Power Dissipation	(Ta = 25°C)	P _D	1.8	W
Operating Temperature		T _{opr}	- 30~75	°C
Storage Temperature		T _{stg}	- 55~150	°C
Operating Junction Temperature		T _j	- 30~150	°C
Thermal Resistance		R _{th(j-a)}	69.4	°C / W

961001EBA2'

- The products described in this document are subject to foreign exchange and foreign trade control laws.
- The information contained herein is presented only as a guide for the applications of our products. No responsibility is assumed by TOSHIBA CORPORATION for any infringements of intellectual property or other rights of the third parties which may result from its use. No license is granted by implication or otherwise under any intellectual property or other rights of TOSHIBA CORPORATION or others.
- The information contained herein is subject to change without notice.

TA78M05SB

ELECTRICAL CHARACTERISTICS

($V_{IN} = 10V$, $I_{OUT} = 350mA$, $0^{\circ}C \leq T_j \leq 125^{\circ}C$, $C_{IN} = 0.33\mu F$, $C_{OUT} = 0.1\mu F$, unless otherwise noted)

CHARACTERISTIC	SYMBOL	TEST CIR-CUIT	TEST CONDITION	MIN.	TYP.	MAX.	UNIT	
Output Voltage	V_{OUT}	1	$T_j = 25^{\circ}C$	4.8	5.0	5.2	V	
Line Regulation	Reg.line	1	$T_j = 25^{\circ}C$	$7V \leq V_{IN} \leq 25V$ $I_{OUT} = 200mA$	—	4	100	mV
				$8V \leq V_{IN} \leq 25V$ $I_{OUT} = 200mA$	—	2	50	
Load Regulation	Reg.load	1	$T_j = 25^{\circ}C$	$5mA \leq I_{OUT} \leq 500mA$	—	25	100	mV
				$5mA \leq I_{OUT} \leq 200mA$	—	10	50	
Output Voltage	V_{OUT}	1	$T_j = 25^{\circ}C$	4.75	—	5.25	V	
Quiescent Current	I_B	1	$T_j = 25^{\circ}C$	—	4.5	8.0	mA	
Quiescent Current Change	Line	1	$8.5V \leq V_{IN} \leq 25.5V$, $I_{OUT} = 200mA$	—	—	0.8	mA	
	Load	1	$5mA \leq I_{OUT} \leq 350mA$	—	—	0.5		
Output Noise Voltage	V_{NO}	2	$T_a = 25^{\circ}C$, $10Hz \leq f \leq 100kHz$	—	50	200	μV_{rms}	
Ripple Rejection	R.R.	3	$f = 120Hz$, $I_{OUT} = 100mA$ $8V \leq V_{IN} \leq 18V$, $T_j = 25^{\circ}C$	62	69	—	dB	
Short Circuit Current Limit	I_{SC}	1	$T_j = 25^{\circ}C$	—	960	—	mA	
Dropout Voltage	V_D	1	$T_a = 25^{\circ}C$	—	1.7	—	V	
Average Temperature Coefficient Of Output Voltage	T_{CVO}	1	$I_{OUT} = 5mA$	—	-0.6	—	mV / $^{\circ}C$	

TA78M06SB

ELECTRICAL CHARACTERISTICS

($V_{IN} = 11V$, $I_{OUT} = 350mA$, $0^{\circ}C \leq T_j \leq 125^{\circ}C$, $C_{IN} = 0.33\mu F$, $C_{OUT} = 0.1\mu F$, unless otherwise noted)

CHARACTERISTIC	SYMBOL	TEST CIR-CUIT	TEST CONDITION	MIN.	TYP.	MAX.	UNIT	
Output Voltage	V_{OUT}	1	$T_j = 25^{\circ}C$	5.75	6.0	6.25	V	
Line Regulation	Reg.line	1	$T_j = 25^{\circ}C$	$8V \leq V_{IN} \leq 25V$ $I_{OUT} = 200mA$	—	4	100	mV
				$9V \leq V_{IN} \leq 25V$ $I_{OUT} = 200mA$	—	2	50	
Load Regulation	Reg.load	1	$T_j = 25^{\circ}C$	$5mA \leq I_{OUT} \leq 500mA$	—	25	120	mV
				$5mA \leq I_{OUT} \leq 200mA$	—	10	60	
Output Voltage	V_{OUT}	1	$T_j = 25^{\circ}C$	5.7	—	6.3	V	
Quiescent Current	I_B	1	$T_j = 25^{\circ}C$	—	4.5	8.0	mA	
Quiescent Current Change	Line	1	$9.5V \leq V_{IN} \leq 25.5V$, $I_{OUT} = 200mA$	—	—	0.8	mA	
	Load	1	$5mA \leq I_{OUT} \leq 350mA$	—	—	0.5		
Output Noise Voltage	V_{NO}	2	$T_a = 25^{\circ}C$, $10Hz \leq f \leq 100kHz$	—	55	220	μV_{rms}	
Ripple Rejection	R.R.	3	$f = 120Hz$, $I_{OUT} = 100mA$ $9V \leq V_{IN} \leq 19V$, $T_j = 25^{\circ}C$	59	66	—	dB	
Short Circuit Current Limit	I_{SC}	1	$T_j = 25^{\circ}C$	—	960	—	mA	
Dropout Voltage	V_D	1	$T_a = 25^{\circ}C$	—	1.7	—	V	
Average Temperature Coefficient Of Output Voltage	T_{CVO}	1	$I_{OUT} = 5mA$	—	-0.7	—	mV / $^{\circ}C$	

TA78M08SB

ELECTRICAL CHARACTERISTICS

($V_{IN} = 14V$, $I_{OUT} = 350mA$, $0^{\circ}C \leq T_j \leq 125^{\circ}C$, $C_{IN} = 0.33\mu F$, $C_{OUT} = 0.1\mu F$, unless otherwise noted)

CHARACTERISTIC	SYMBOL	TEST CIR-CUIT	TEST CONDITION	MIN.	TYP.	MAX.	UNIT	
Output Voltage	V_{OUT}	1	$T_j = 25^{\circ}C$	7.7	8.0	8.3	V	
Line Regulation	Reg.line	1	$T_j = 25^{\circ}C$	$10.5V \leq V_{IN} \leq 25V$ $I_{OUT} = 200mA$	—	5	100	mV
				$11V \leq V_{IN} \leq 25V$ $I_{OUT} = 200mA$	—	3	50	
Load Regulation	Reg.load	1	$T_j = 25^{\circ}C$	$5mA \leq I_{OUT} \leq 500mA$	—	26	160	mV
				$5mA \leq I_{OUT} \leq 200mA$	—	10	80	
Output Voltage	V_{OUT}	1	$T_j = 25^{\circ}C$	$10.5V \leq V_{IN} \leq 23V$ $5mA \leq I_{OUT} \leq 350mA$	7.6	—	8.4	V
Quiescent Current	I_B	1	$T_j = 25^{\circ}C$	—	4.6	8.0	mA	
Quiescent Current Change	Line	1	$11V \leq V_{IN} \leq 25.5V$, $I_{OUT} = 200mA$	—	—	0.8	mA	
	Load	1	$5mA \leq I_{OUT} \leq 350mA$	—	—	0.5		
Output Noise Voltage	V_{NO}	2	$T_a = 25^{\circ}C$, $10Hz \leq f \leq 100kHz$	—	60	250	μV_{rms}	
Ripple Rejection	R.R.	3	$f = 120Hz$, $I_{OUT} = 100mA$ $11.5V \leq V_{IN} \leq 21.5V$, $T_j = 25^{\circ}C$	56	63	—	dB	
Short Circuit Current Limit	I_{SC}	1	$T_j = 25^{\circ}C$	—	960	—	mA	
Dropout Voltage	V_D	1	$T_a = 25^{\circ}C$	—	1.7	—	V	
Average Temperature Coefficient Of Output Voltage	T_{CVO}	1	$I_{OUT} = 5mA$	—	-1.0	—	mV / $^{\circ}C$	

TA78M09SB

ELECTRICAL CHARACTERISTICS

($V_{IN} = 15V$, $I_{OUT} = 350mA$, $0^{\circ}C \leq T_j \leq 125^{\circ}C$, $C_{IN} = 0.33\mu F$, $C_{OUT} = 0.1\mu F$, unless otherwise noted)

CHARACTERISTIC	SYMBOL	TEST CIR-CUIT	TEST CONDITION	MIN.	TYP.	MAX.	UNIT	
Output Voltage	V_{OUT}	1	$T_j = 25^{\circ}C$	8.64	9.0	9.36	V	
Line Regulation	Reg.line	1	$T_j = 25^{\circ}C$	$11.5V \leq V_{IN} \leq 26V$ $I_{OUT} = 200mA$	—	5	100	mV
				$13V \leq V_{IN} \leq 26V$ $I_{OUT} = 200mA$	—	3	50	
Load Regulation	Reg.load	1	$T_j = 25^{\circ}C$	$5mA \leq I_{OUT} \leq 500mA$	—	26	180	mV
				$5mA \leq I_{OUT} \leq 200mA$	—	10	90	
Output Voltage	V_{OUT}	1	$T_j = 25^{\circ}C$	$11.5V \leq V_{IN} \leq 24V$ $5mA \leq I_{OUT} \leq 350mA$	8.55	—	9.45	V
Quiescent Current	I_B	1	$T_j = 25^{\circ}C$	—	4.6	8.0	mA	
Quiescent Current Change	Line	1	$12V \leq V_{IN} \leq 26.5V$, $I_{OUT} = 200mA$	—	—	0.8	mA	
	Load							$5mA \leq I_{OUT} \leq 350mA$
Output Noise Voltage	V_{NO}	2	$T_a = 25^{\circ}C$, $10Hz \leq f \leq 100kHz$	—	60	270	μV_{rms}	
Ripple Rejection	R.R.	3	$f = 120Hz$, $I_{OUT} = 100mA$ $12.5V \leq V_{IN} \leq 22.5V$, $T_j = 25^{\circ}C$	56	63	—	dB	
Short Circuit Current Limit	I_{SC}	1	$T_j = 25^{\circ}C$	—	960	—	mA	
Dropout Voltage	V_D	1	$T_a = 25^{\circ}C$	—	1.7	—	V	
Average Temperature Coefficient Of Output Voltage	T_{CVO}	1	$I_{OUT} = 5mA$	—	-1.1	—	mV / $^{\circ}C$	

TA78M10SB

ELECTRICAL CHARACTERISTICS

($V_{IN} = 16V$, $I_{OUT} = 350mA$, $0^{\circ}C \leq T_j \leq 125^{\circ}C$, $C_{IN} = 0.33\mu F$, $C_{OUT} = 0.1\mu F$, unless otherwise noted)

CHARACTERISTIC	SYMBOL	TEST CIR-CUIT	TEST CONDITION	MIN.	TYP.	MAX.	UNIT	
Output Voltage	V_{OUT}	1	$T_j = 25^{\circ}C$	9.6	10.0	10.4	V	
Line Regulation	Reg.line	1	$T_j = 25^{\circ}C$	$12.5V \leq V_{IN} \leq 26V$ $I_{OUT} = 200mA$	—	6	100	mV
				$14V \leq V_{IN} \leq 26V$ $I_{OUT} = 200mA$	—	3	50	
Load Regulation	Reg.load	1	$T_j = 25^{\circ}C$	$5mA \leq I_{OUT} \leq 500mA$	—	26	200	mV
				$5mA \leq I_{OUT} \leq 200mA$	—	10	100	
Output Voltage	V_{OUT}	1	$T_j = 25^{\circ}C$	9.5	—	10.5	V	
Quiescent Current	I_B	1	$T_j = 25^{\circ}C$	—	4.7	8.0	mA	
Quiescent Current Change	Line	1	$13V \leq V_{IN} \leq 26.5V$, $I_{OUT} = 200mA$	—	—	0.8	mA	
	Load	1	$5mA \leq I_{OUT} \leq 350mA$	—	—	0.5		
Output Noise Voltage	V_{NO}	2	$T_a = 25^{\circ}C$, $10Hz \leq f \leq 100kHz$	—	65	280	μV_{rms}	
Ripple Rejection	R.R.	3	$f = 120Hz$, $I_{OUT} = 100mA$ $13.5V \leq V_{IN} \leq 23.5V$, $T_j = 25^{\circ}C$	55	62	—	dB	
Short Circuit Current Limit	I_{SC}	1	$T_j = 25^{\circ}C$	—	960	—	mA	
Dropout Voltage	V_D	1	$T_a = 25^{\circ}C$	—	1.7	—	V	
Average Temperature Coefficient Of Output Voltage	T_{CVO}	1	$I_{OUT} = 5mA$	—	-1.3	—	mV / $^{\circ}C$	

TA78M12SB

ELECTRICAL CHARACTERISTICS

($V_{IN} = 19V$, $I_{OUT} = 350mA$, $0^{\circ}C \leq T_j \leq 125^{\circ}C$, $C_{IN} = 0.33\mu F$, $C_{OUT} = 0.1\mu F$, unless otherwise noted)

CHARACTERISTIC	SYMBOL	TEST CIR-CUIT	TEST CONDITION	MIN.	TYP.	MAX.	UNIT	
Output Voltage	V_{OUT}	1	$T_j = 25^{\circ}C$	11.5	12.0	12.5	V	
Line Regulation	Reg.line	1	$T_j = 25^{\circ}C$	$14.5V \leq V_{IN} \leq 30V$ $I_{OUT} = 200mA$	—	7	100	mV
				$16V \leq V_{IN} \leq 30V$ $I_{OUT} = 200mA$	—	3	50	
Load Regulation	Reg.load	1	$T_j = 25^{\circ}C$	$5mA \leq I_{OUT} \leq 500mA$	—	27	240	mV
				$5mA \leq I_{OUT} \leq 200mA$	—	10	120	
Output Voltage	V_{OUT}	1	$T_j = 25^{\circ}C$	$14.5V \leq V_{IN} \leq 27V$ $5mA \leq I_{OUT} \leq 350mA$	11.4	—	12.6	V
Quiescent Current	I_B	1	$T_j = 25^{\circ}C$	—	4.8	8.0	mA	
Quiescent Current Change	Line	1	$15V \leq V_{IN} \leq 30.5V$, $I_{OUT} = 200mA$	—	—	0.8	mA	
	Load	1	$5mA \leq I_{OUT} \leq 350mA$	—	—	0.5		
Output Noise Voltage	V_{NO}	2	$T_a = 25^{\circ}C$, $10Hz \leq f \leq 100kHz$	—	70	300	μV_{rms}	
Ripple Rejection	R.R.	3	$f = 120Hz$, $I_{OUT} = 100mA$ $15V \leq V_{IN} \leq 25V$, $T_j = 25^{\circ}C$	55	62	—	dB	
Short Circuit Current Limit	I_{SC}	1	$T_j = 25^{\circ}C$	—	960	—	mA	
Dropout Voltage	V_D	1	$T_a = 25^{\circ}C$	—	1.7	—	V	
Average Temperature Coefficient Of Output Voltage	T_{CVO}	1	$I_{OUT} = 5mA$	—	-1.6	—	mV / $^{\circ}C$	

TA78M15SB

ELECTRICAL CHARACTERISTICS

($V_{IN} = 23V$, $I_{OUT} = 350mA$, $0^{\circ}C \leq T_j \leq 125^{\circ}C$, $C_{IN} = 0.33\mu F$, $C_{OUT} = 0.1\mu F$, unless otherwise noted)

CHARACTERISTIC	SYMBOL	TEST CIR-CUIT	TEST CONDITION	MIN.	TYP.	MAX.	UNIT	
Output Voltage	V_{OUT}	1	$T_j = 25^{\circ}C$	14.4	15.0	15.6	V	
Line Regulation	Reg.line	1	$T_j = 25^{\circ}C$	$17.5V \leq V_{IN} \leq 30V$ $I_{OUT} = 200mA$	—	8	100	mV
				$20V \leq V_{IN} \leq 30V$ $I_{OUT} = 200mA$	—	4	50	
Load Regulation	Reg.load	1	$T_j = 25^{\circ}C$	$5mA \leq I_{OUT} \leq 500mA$	—	27	300	mV
				$5mA \leq I_{OUT} \leq 200mA$	—	10	150	
Output Voltage	V_{OUT}	1	$T_j = 25^{\circ}C$	14.25	—	15.75	V	
Quiescent Current	I_B	1	$T_j = 25^{\circ}C$	—	4.8	8.0	mA	
Quiescent Current Change	Line	1	$18V \leq V_{IN} \leq 30.5V$, $I_{OUT} = 200mA$	—	—	0.8	mA	
	Load			$5mA \leq I_{OUT} \leq 350mA$	—	—		0.5
Output Noise Voltage	V_{NO}	2	$T_a = 25^{\circ}C$, $10Hz \leq f \leq 100kHz$	—	80	450	μV_{rms}	
Ripple Rejection	R.R.	3	$f = 120Hz$, $I_{OUT} = 100mA$ $18.5V \leq V_{IN} \leq 28.5V$, $T_j = 25^{\circ}C$	54	61	—	dB	
Short Circuit Current Limit	I_{SC}	1	$T_j = 25^{\circ}C$	—	960	—	mA	
Dropout Voltage	V_D	1	$T_a = 25^{\circ}C$	—	1.7	—	V	
Average Temperature Coefficient Of Output Voltage	T_{CVO}	1	$I_{OUT} = 5mA$	—	-2.0	—	mV / $^{\circ}C$	

TA78M18SB

ELECTRICAL CHARACTERISTICS

($V_{IN} = 27V$, $I_{OUT} = 350mA$, $0^{\circ}C \leq T_j \leq 125^{\circ}C$, $C_{IN} = 0.33\mu F$, $C_{OUT} = 0.1\mu F$, unless otherwise noted)

CHARACTERISTIC	SYMBOL	TEST CIR-CUIT	TEST CONDITION	MIN.	TYP.	MAX.	UNIT	
Output Voltage	V_{OUT}	1	$T_j = 25^{\circ}C$	17.3	18.0	18.7	V	
Line Regulation	Reg.line	1	$T_j = 25^{\circ}C$	$21V \leq V_{IN} \leq 33V$ $I_{OUT} = 200mA$	—	9	100	mV
				$24V \leq V_{IN} \leq 33V$ $I_{OUT} = 200mA$	—	5	50	
Load Regulation	Reg.load	1	$T_j = 25^{\circ}C$	$5mA \leq I_{OUT} \leq 500mA$	—	28	360	mV
				$5mA \leq I_{OUT} \leq 200mA$	—	10	180	
Output Voltage	V_{OUT}	1	$T_j = 25^{\circ}C$	$21V \leq V_{IN} \leq 33V$ $5mA \leq I_{OUT} \leq 350mA$	17.1	—	18.9	V
Quiescent Current	I_B	1	$T_j = 25^{\circ}C$	—	4.8	8.0	mA	
Quiescent Current Change	Line	ΔI_B	1	$21.5V \leq V_{IN} \leq 33.5V$, $I_{OUT} = 200mA$	—	—	0.8	mA
	Load	ΔI_{BO}	1	$5mA \leq I_{OUT} \leq 350mA$	—	—	0.5	
Output Noise Voltage	V_{NO}	2	$T_a = 25^{\circ}C$, $10Hz \leq f \leq 100kHz$	—	90	490	μV_{rms}	
Ripple Rejection	R.R.	3	$f = 120Hz$, $I_{OUT} = 100mA$ $22V \leq V_{IN} \leq 32V$, $T_j = 25^{\circ}C$	53	60	—	dB	
Short Circuit Current Limit	I_{SC}	1	$T_j = 25^{\circ}C$	—	960	—	mA	
Dropout Voltage	V_D	1	$T_a = 25^{\circ}C$	—	1.7	—	V	
Average Temperature Coefficient Of Output Voltage	T_{CVO}	1	$I_{OUT} = 5mA$	—	-2.5	—	mV / $^{\circ}C$	

TA78M20SB

ELECTRICAL CHARACTERISTICS

($V_{IN} = 29V$, $I_{OUT} = 350mA$, $0^{\circ}C \leq T_j \leq 125^{\circ}C$, $C_{IN} = 0.33\mu F$, $C_{OUT} = 0.1\mu F$, unless otherwise noted)

CHARACTERISTIC	SYMBOL	TEST CIR-CUIT	TEST CONDITION	MIN.	TYP.	MAX.	UNIT	
Output Voltage	V_{OUT}	1	$T_j = 25^{\circ}C$	19.2	20.0	20.8	V	
Line Regulation	Reg.line	1	$T_j = 25^{\circ}C$	$23V \leq V_{IN} \leq 35V$ $I_{OUT} = 200mA$	—	10	100	mV
				$24V \leq V_{IN} \leq 35V$ $I_{OUT} = 200mA$	—	6	50	
Load Regulation	Reg.load	1	$T_j = 25^{\circ}C$	$5mA \leq I_{OUT} \leq 500mA$	—	28	400	mV
				$5mA \leq I_{OUT} \leq 200mA$	—	10	200	
Output Voltage	V_{OUT}	1	$T_j = 25^{\circ}C$	$23V \leq V_{IN} \leq 35V$ $5mA \leq I_{OUT} \leq 350mA$	19.0	—	21.0	V
Quiescent Current	I_B	1	$T_j = 25^{\circ}C$	—	4.9	8.0	mA	
Quiescent Current Change	Line	ΔI_B	1	$23.5V \leq V_{IN} \leq 35.5V$, $I_{OUT} = 200mA$	—	—	0.8	mA
	Load	ΔI_{BO}	1	$5mA \leq I_{OUT} \leq 350mA$	—	—	0.5	
Output Noise Voltage	V_{NO}	2	$T_a = 25^{\circ}C$, $10Hz \leq f \leq 100kHz$	—	95	540	μV_{rms}	
Ripple Rejection	R.R.	3	$f = 120Hz$, $I_{OUT} = 100mA$ $24V \leq V_{IN} \leq 34V$, $T_j = 25^{\circ}C$	53	60	—	dB	
Short Circuit Current Limit	I_{SC}	1	$T_j = 25^{\circ}C$	—	960	—	mA	
Dropout Voltage	V_D	1	$T_a = 25^{\circ}C$	—	1.7	—	V	
Average Temperature Coefficient Of Output Voltage	T_{CVO}	1	$I_{OUT} = 5mA$	—	-3.0	—	mV / $^{\circ}C$	

TA78M24SB

ELECTRICAL CHARACTERISTICS

($V_{IN} = 33V$, $I_{OUT} = 350mA$, $0^{\circ}C \leq T_j \leq 125^{\circ}C$, $C_{IN} = 0.33\mu F$, $C_{OUT} = 0.1\mu F$, unless otherwise noted)

CHARACTERISTIC	SYMBOL	TEST CIR-CUIT	TEST CONDITION	MIN.	TYP.	MAX.	UNIT
Output Voltage	V_{OUT}	1	$T_j = 25^{\circ}C$	23.0	24.0	25.0	V
Line Regulation	Reg.line	1	$T_j = 25^{\circ}C$ $27V \leq V_{IN} \leq 38V$ $I_{OUT} = 200mA$	—	12	100	mV
				—	7	50	
Load Regulation	Reg.load	1	$T_j = 25^{\circ}C$ $5mA \leq I_{OUT} \leq 500mA$ $5mA \leq I_{OUT} \leq 200mA$	—	30	480	mV
				—	10	240	
Output Voltage	V_{OUT}	1	$T_j = 25^{\circ}C$ $27V \leq V_{IN} \leq 38V$ $5mA \leq I_{OUT} \leq 350mA$	22.8	—	25.2	V
Quiescent Current	I_B	1	$T_j = 25^{\circ}C$	—	5.0	8.0	mA
Quiescent Current Change	Line	1	$27.5V \leq V_{IN} \leq 38.5V$, $I_{OUT} = 200mA$	—	—	0.8	mA
	Load	1	$5mA \leq I_{OUT} \leq 350mA$	—	—	0.5	
Output Noise Voltage	V_{NO}	2	$T_a = 25^{\circ}C$, $10Hz \leq f \leq 100kHz$	—	115	650	μV_{rms}
Ripple Rejection	R.R.	3	$f = 120Hz$, $I_{OUT} = 100mA$ $28V \leq V_{IN} \leq 38V$, $T_j = 25^{\circ}C$	50	57	—	dB
Short Circuit Current Limit	I_{SC}	1	$T_j = 25^{\circ}C$	—	960	—	mA
Dropout Voltage	V_D	1	$T_a = 25^{\circ}C$	—	1.7	—	V
Average Temperature Coefficient Of Output Voltage	T_{CVO}	1	$I_{OUT} = 5mA$	—	-3.5	—	mV / $^{\circ}C$

TEST CIRCUIT 1 / STANDARD APPLICATION

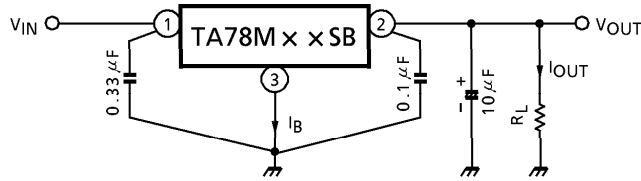

TEST CIRCUIT 2 V_{NO}

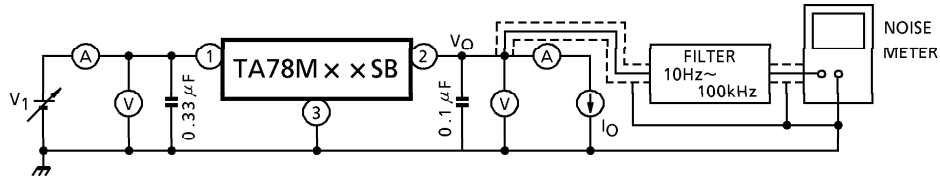

TEST CIRCUIT 3 R.R.

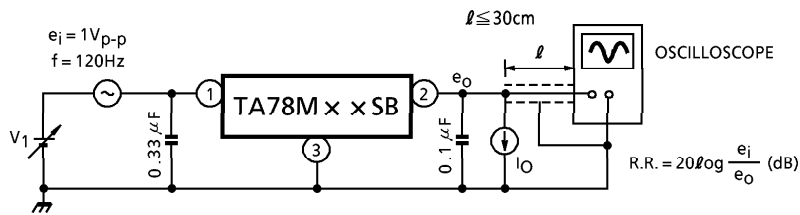

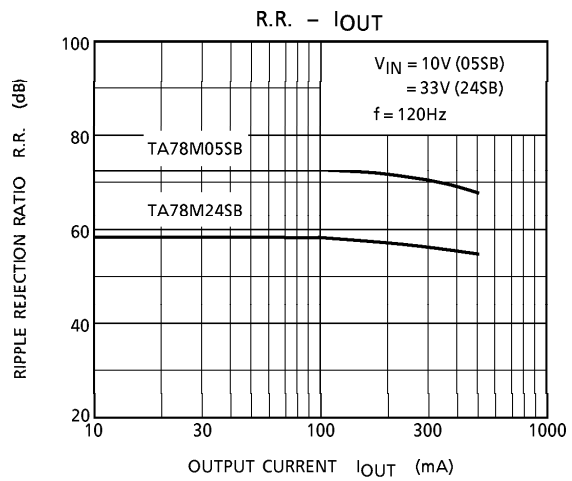
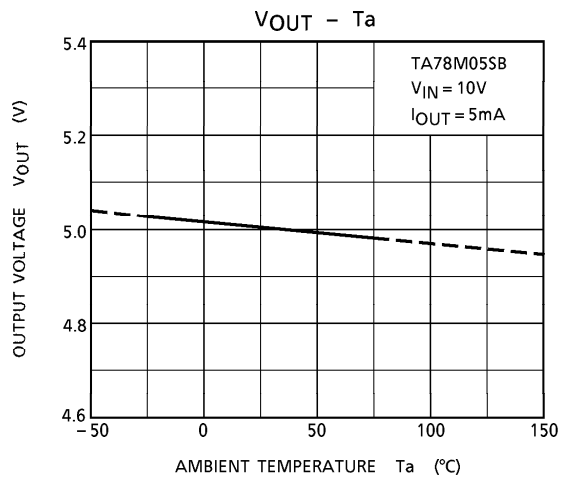
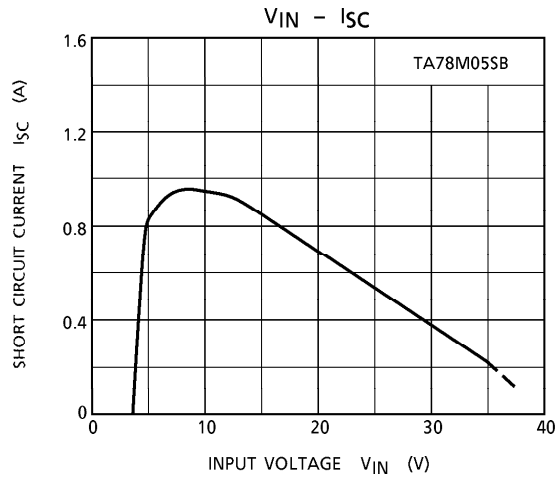
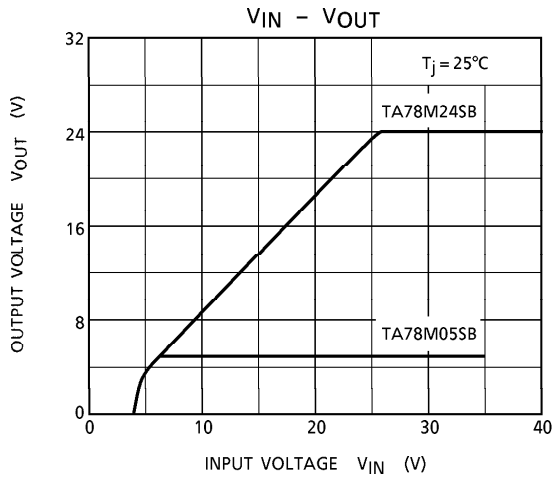
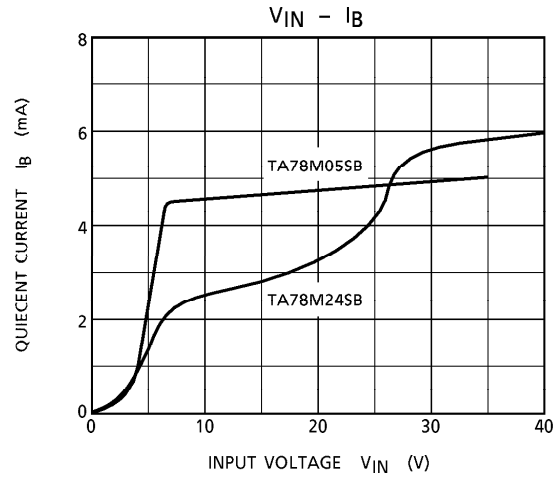
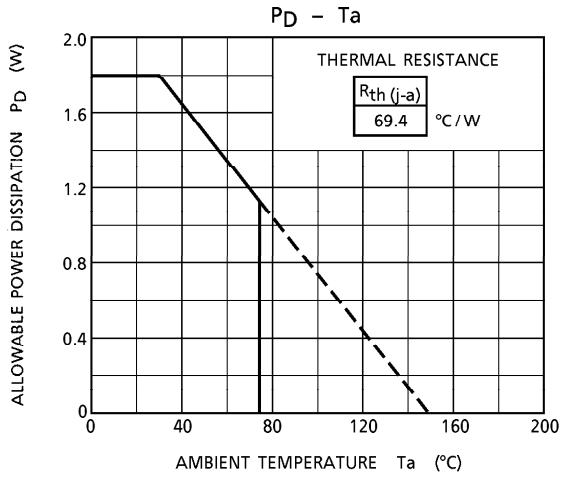

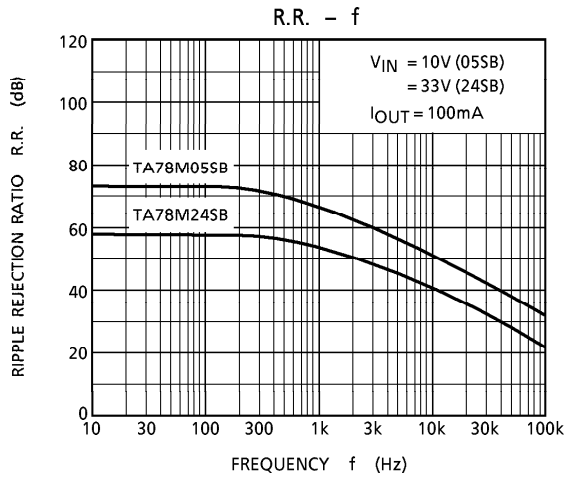

PRECAUTIONS ON APPLICATION

- (1) In regard to GND, be careful not to apply a negative voltage to the input/output terminal. Further, special care is necessary in case of a voltage boost application.
- (2) When a surge voltage exceeding maximum rating is applied to the input terminal or when a voltage in excess of the input terminal voltage is applied to the output terminal, the circuit may be destroyed.

Specially, in the latter case, great care is necessary.

Further, if the input terminal sorts to GND in a state of normal operation, the output terminal voltage becomes higher than the input voltage (GND potential), and the electric charge of a chemical capacitor connected to the output terminal flows into the input side, which may cause the destruction of circuit.

In these cases, take such steps as a zener diode and a general silicon diode are connected to the circuit, as shown in the following figure.

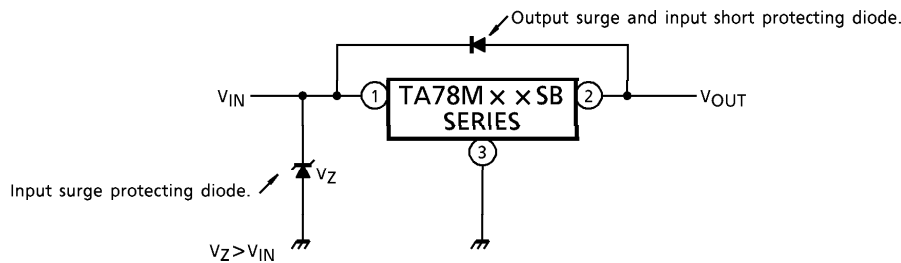

- (3) When the input voltage is too high, the power dissipation of three terminal regulator increases because of series regulator, so that the junction temperature rises. In such a case, it is recommended to reduce the power dissipation by inserting the power limiting resistor R_{SD} in the input terminal, and to reduce the junction temperature as a result.

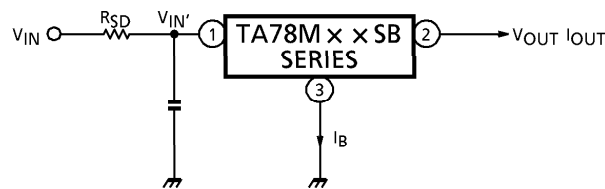

The power dissipation P_D of IC is expressed in the following equation.

$$P_D = (V_{IN}' - V_{OUT}) \cdot I_{OUT} + V_{IN}' \cdot I_B$$

If V_{IN}' is reduced below the lowest voltage necessary for the IC, the parasitic oscillation will be caused according to circumstances.

In determining the resistance value of R_{SD}, design with margin should be made by making reference to the following equation.

$$R_{SD} < \frac{V_{IN} - V_{IN}'}{I_{OUT} + I_B}$$

- (4) Connect the input terminal and GND, and the output terminal and GND, by capacitor respectively. The capacitances should be determined experimentally because they depend on printed patterns. In particular, adequate investigation should be made so that there is no problem even at time of high or low temperature.

APPLICATION CIRCUITS

(1) VOLTAGE BOOST REGULATOR

(a) Voltage boost by use of zener diode

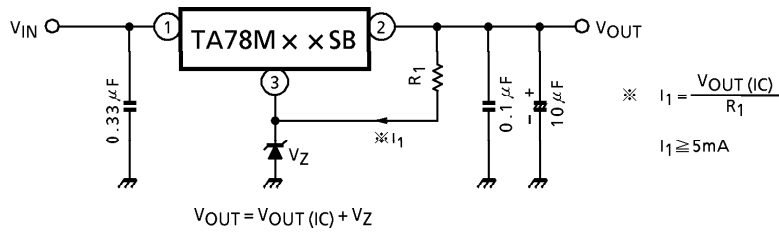

(b) Voltage boost by use of resistor

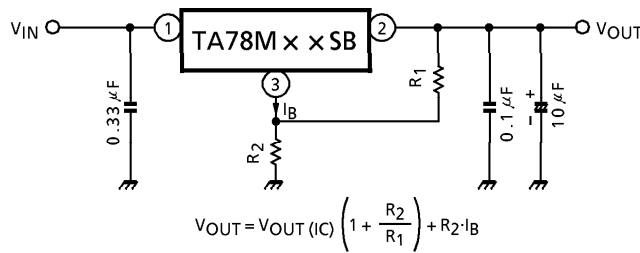

(c) Adjustable output regulator

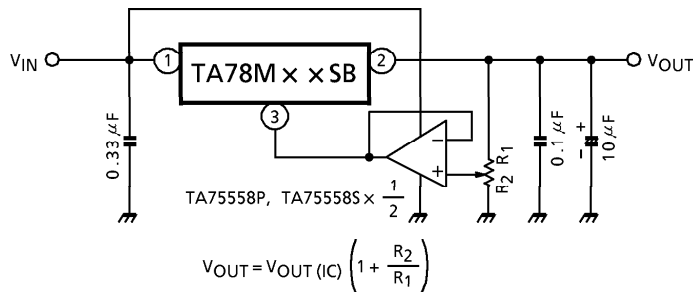

(2) CURRENT BOOST REGULATOR

(a) CURRENT BOOST VOLTAGE REGULATOR

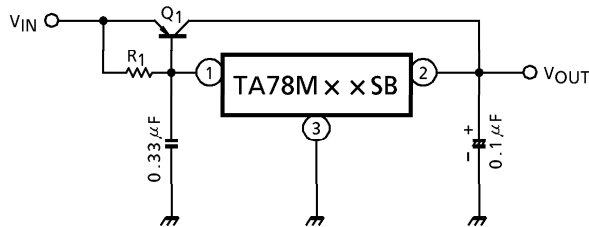

Heat sink is needed for Q1

$$R_1 \cong \frac{V_{BE1}}{I_B \text{ MAX}}$$

where,

V_{BE1} : V_{BE} of external transistor Q1.

$I_B \text{ MAX}$: Quiescent current of IC.

(b) SHORT-CIRCUIT PROTECTION

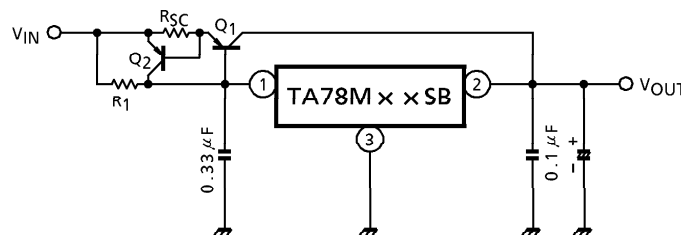

$$R_{SC} = \frac{V_{BE2}}{I_{SC}}$$

where,

I_{SC} : Short-circuit current

(3) NEGATIVE REGULATOR

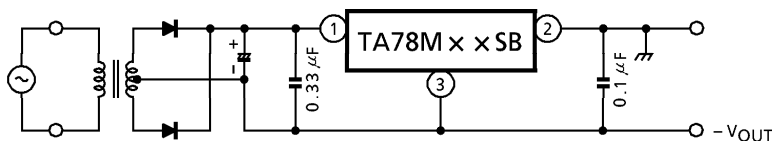

(4) POSITIVE AND NEGATIVE REGULATOR

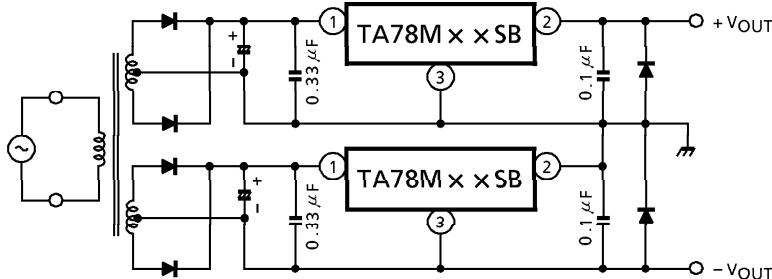

(5) CURRENT REGULATOR

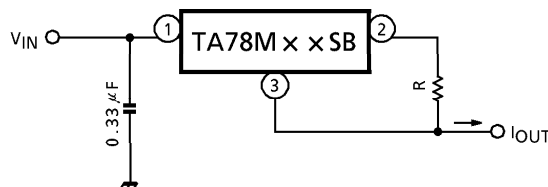

$$I_{OUT} = \frac{V_{OUT}}{R} + I_B$$

OUTLINE DRAWING
SIP3-P-2.50A

Unit : mm

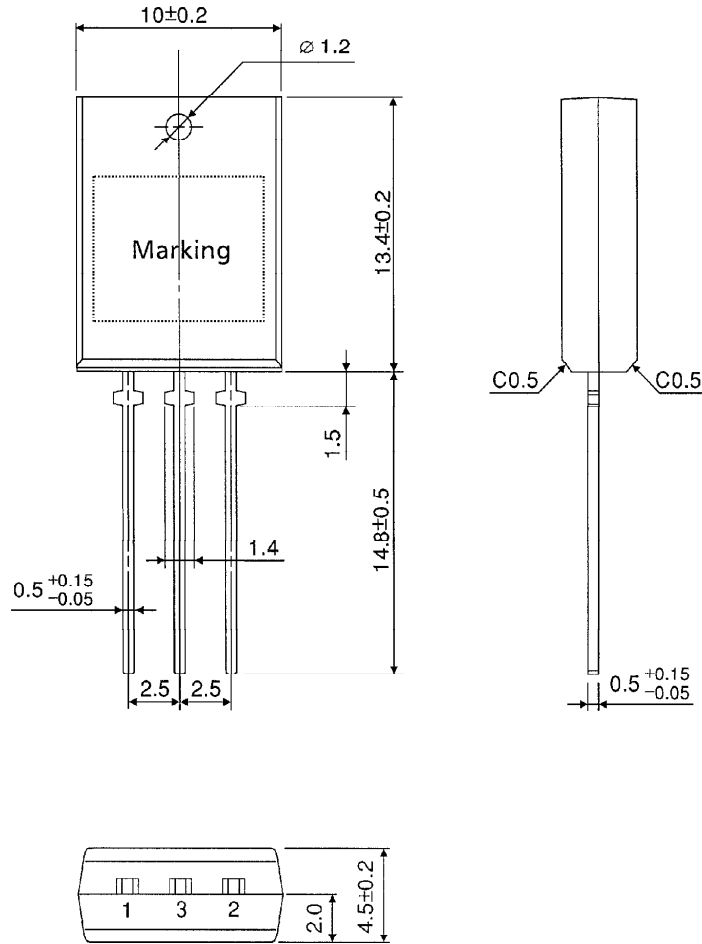

Weight : 1.5g (Typ.)