

**TC7WU04F, TC7WU04FU, TC7WU04FK**

**3 INVERTER**

The TC7WU04 is a high speed C<sup>2</sup>MOS INVERTER fabricated with silicon gate C<sup>2</sup>MOS technology. It achieves the high speed operation similar to equivalent LSTTL while maintaining the C<sup>2</sup>MOS low power dissipation.

As the internal circuit is composed of single stage inverter, it can be applied for crystal oscillation.

All inputs are equipped with protection circuits against static discharge or transient excess voltage.

**FEATURES**

- High Speed .....  $t_{pd} = 6ns$  (Typ.) at  $V_{CC} = 5V$
- Low Power Dissipation .....  $I_{CC} = 1\mu A$  (Max.) at  $T_a = 25^\circ C$
- High Noise Immunity .....  $V_{NIH} = V_{NIL} = 10\% V_{CC}$  (Min.)
- Output Drive Capability ..... 10 LSTTL Loads
- Symmetrical Output Impedance ...  $|I_{OH}| = I_{OL} = 4mA$  (Min.)
- Balanced Propagation Delays .....  $t_{pLH} \cong t_{pHL}$
- Wide Operating Voltage Range ...  $V_{CC} (opr) = 2\sim 6V$

**MARKING**

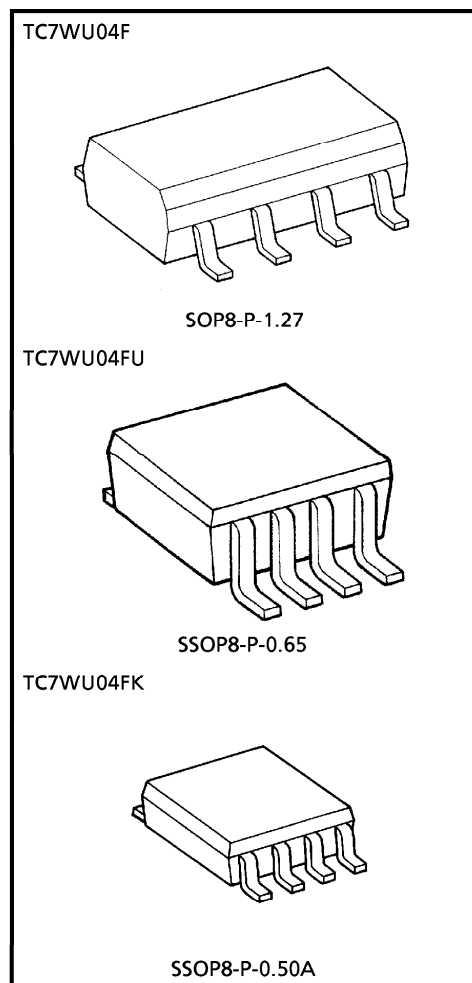
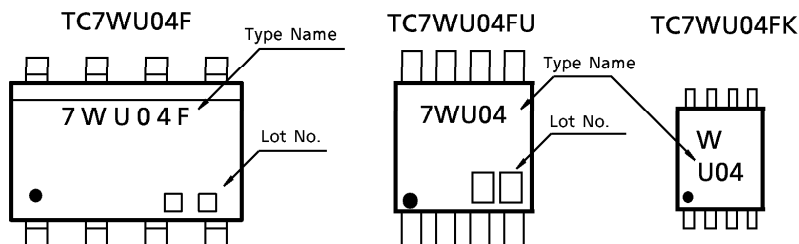

<b>Weight</b>	
SOP8-P-1.27	: 0.05g (Typ.)
SSOP8-P-0.65	: 0.02g (Typ.)
SSOP8-P-0.50A	: 0.01g (Typ.)

980910EBA1

- TOSHIBA is continually working to improve the quality and the reliability of its products. Nevertheless, semiconductor devices in general can malfunction or fail due to their inherent electrical sensitivity and vulnerability to physical stress. It is the responsibility of the buyer, when utilizing TOSHIBA products, to observe standards of safety, and to avoid situations in which a malfunction or failure of a TOSHIBA product could cause loss of human life, bodily injury or damage to property. In developing your designs, please ensure that TOSHIBA products are used within specified operating ranges as set forth in the most recent products specifications. Also, please keep in mind the precautions and conditions set forth in the TOSHIBA Semiconductor Reliability Handbook.
- The products described in this document are subject to the foreign exchange and foreign trade laws.
- The information contained herein is presented only as a guide for the applications of our products. No responsibility is assumed by TOSHIBA CORPORATION for any infringements of intellectual property or other rights of the third parties which may result from its use. No license is granted by implication or otherwise under any intellectual property or other rights of TOSHIBA CORPORATION or others.
- The information contained herein is subject to change without notice.

**MAXIMUM RATINGS** (Ta = 25°C)

CHARACTERISTIC	SYMBOL	RATING	UNIT
Supply Voltage Range	V <sub>CC</sub>	- 0.5~7	V
DC Input Voltage	V <sub>IN</sub>	- 0.5~V <sub>CC</sub> + 0.5	V
DC Output Voltage	V <sub>OUT</sub>	- 0.5~V <sub>CC</sub> + 0.5	V
Input Diode Current	I <sub>IK</sub>	± 20	mA
Output Diode Current	I <sub>OK</sub>	± 20	mA
DC Output Current	I <sub>OUT</sub>	± 25	mA
DC V <sub>CC</sub> / Ground Current	I <sub>CC</sub>	± 25	mA
Power Dissipation	P <sub>D</sub>	300	mW
Storage Temperature	T <sub>stg</sub>	- 65~150	°C
Lead Temperature (10s)	T <sub>L</sub>	260	°C

**LOGIC DIAGRAM**

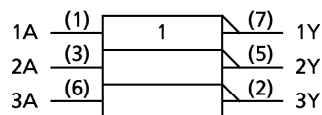

**TRUTH TABLE**

A	Y
L	H
H	L

**PIN ASSIGNMENT (TOP VIEW)**

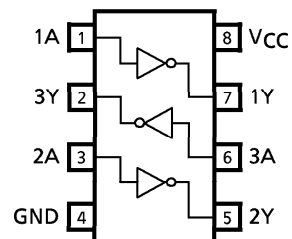

**RECOMMENDED OPERATING CONDITIONS**

CHARACTERISTIC	SYMBOL	RATING	UNIT
Supply Voltage	V <sub>CC</sub>	2~6	V
Input Voltage	V <sub>IN</sub>	0~V <sub>CC</sub>	V
Output Voltage	V <sub>OUT</sub>	0~V <sub>CC</sub>	V
Operating Temperature	T <sub>opr</sub>	- 40~85	°C

**DC ELECTRICAL CHARACTERISTICS**

CHARACTERISTIC	SYMBOL	TEST CONDITION		Ta = 25°C			Ta = -40~85°C		UNIT	
				V <sub>CC</sub>	MIN.	TYP.	MAX.	MIN.		MAX.
High-Level Input Voltage	V <sub>IH</sub>	—		2.0	1.7	—	—	1.7	—	V
				4.5	3.6	—	—	3.6	—	
				6.0	4.8	—	—	4.8	—	
Low-Level Input Voltage	V <sub>IL</sub>	—		2.0	—	—	0.3	—	0.3	V
				4.5	—	—	0.9	—	0.9	
				6.0	—	—	1.2	—	1.2	
High-Level Output Voltage	V <sub>OH</sub>	V <sub>IN</sub> = V <sub>IL</sub>	I <sub>OH</sub> = -20μA	2.0	1.8	2.0	—	1.8	—	V
				4.5	4.0	4.5	—	4.0	—	
		V <sub>IN</sub> = GND	I <sub>OH</sub> = -4mA I <sub>OH</sub> = -5.2mA	4.5	4.18	4.31	—	4.13	—	
				6.0	5.68	5.80	—	5.63	—	
Low-Level Output Voltage	V <sub>OL</sub>	V <sub>IN</sub> = V <sub>IH</sub>	I <sub>OL</sub> = 20μA	2.0	—	0.0	0.2	—	0.2	V
				4.5	—	0.0	0.5	—	0.5	
		V <sub>IN</sub> = V <sub>CC</sub>	I <sub>OL</sub> = 4mA I <sub>OL</sub> = 5.2mA	4.5	—	0.17	0.26	—	0.33	
				6.0	—	0.18	0.26	—	0.33	
Input Leakage Current	I <sub>IN</sub>	V <sub>IN</sub> = V <sub>CC</sub> or GND		6.0	—	—	±0.1	—	±1.0	μA
Quiescent Supply Current	I <sub>CC</sub>	V <sub>IN</sub> = V <sub>CC</sub> or GND		6.0	—	—	1.0	—	10.0	

**AC ELECTRICAL CHARACTERISTICS (C<sub>L</sub> = 15pF, V<sub>CC</sub> = 5V, Ta = 25°C)**

CHARACTERISTIC	SYMBOL	TEST CONDITION	Ta = 25°C			UNIT
			MIN.	TYP.	MAX.	
Output Transition Time	t <sub>TLH</sub>	—	—	4	8	ns
	t <sub>THL</sub>					
Propagation Delay Time	t <sub>pLH</sub>	—	—	4	8	ns
	t <sub>pHL</sub>					

**AC ELECTRICAL CHARACTERISTICS (C<sub>L</sub> = 50pF, Input t<sub>r</sub> = t<sub>f</sub> = 6ns)**

CHARACTERISTIC	SYMBOL	TEST CONDITION		Ta = 25°C			Ta = -40~85°C		UNIT	
				V <sub>CC</sub>	MIN.	TYP.	MAX.	MIN.		MAX.
Output Transition Time	t <sub>TLH</sub> t <sub>THL</sub>	—		2.0	—	30	75	—	95	ns
				4.5	—	8	15	—	19	
				6.0	—	7	13	—	16	
Propagation Delay Time	t <sub>pLH</sub> t <sub>pHL</sub>	—		2.0	—	18	60	—	75	ns
				4.5	—	6	12	—	15	
				6.0	—	5	10	—	13	
Input Capacitance	C <sub>IN</sub>	—		—	9	15	—	15	pF	
Power Dissipation Capacitance	C <sub>PD</sub>	(Note 1)		—	13	—	—	—		

Note 1 : C<sub>PD</sub> is defined as the value of internal equivalent capacitance of IC which is calculated from the operating current consumption without load (refer to Test Circuit). Average operating current can be obtained by the equation hereunder.

$$I_{CC (opr)} = C_{PD} \cdot V_{CC} \cdot f_{IN} + I_{CC} / 3 \text{ (per gate)}$$

**SWITCHING CHARACTERISTICS TEST CIRCUIT**

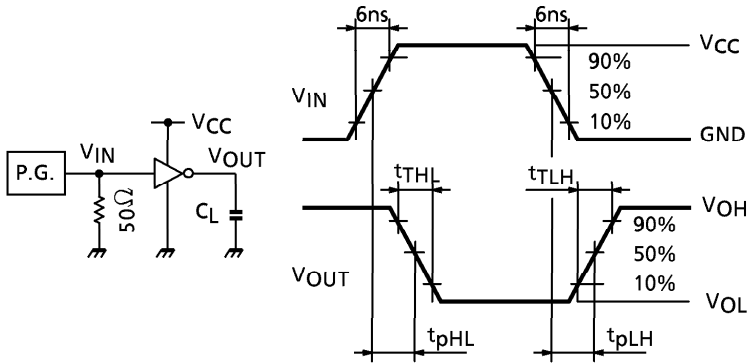

**OPERATING CURRENT CONSUMPTION TEST CIRCUIT**

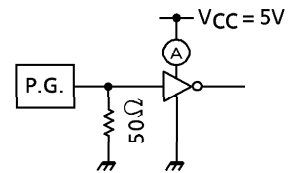

This input waveform is equal to SWITCHING CHARACTERISTICS TEST CIRCUIT input waveform.

OUTLINE DRAWING  
SOP8-P-1.27

Unit : mm

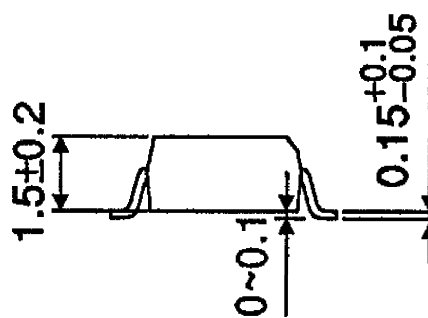
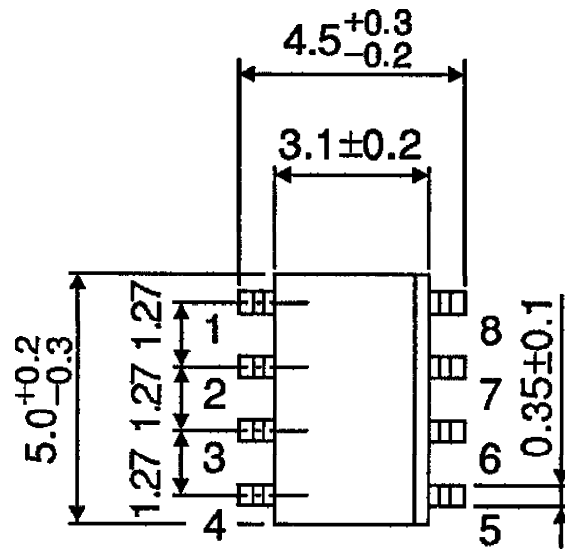

Weight : 0.05g (Typ.)

OUTLINE DRAWING  
SSOP8-P-0.65

Unit : mm

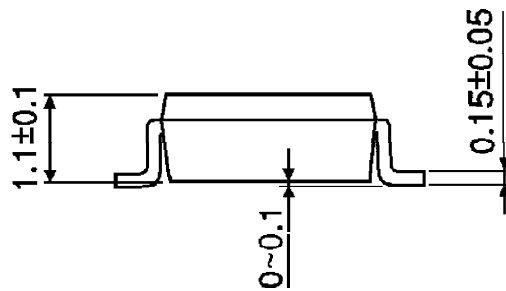
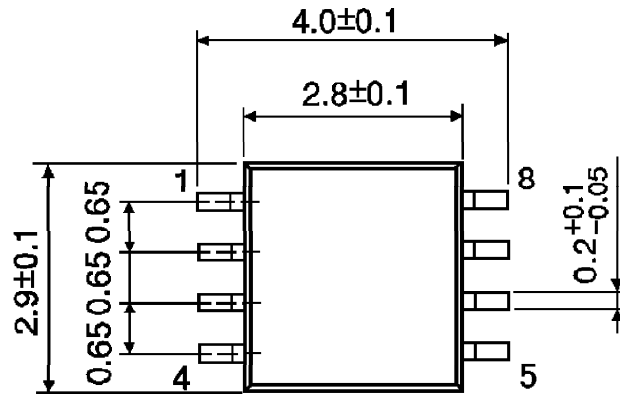

Weight : 0.02g (Typ.)

OUTLINE DRAWING  
SSOP8-P-0.50A

Unit : mm

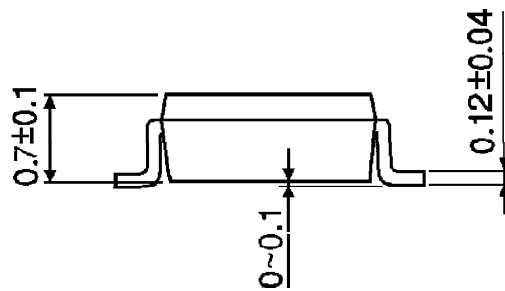
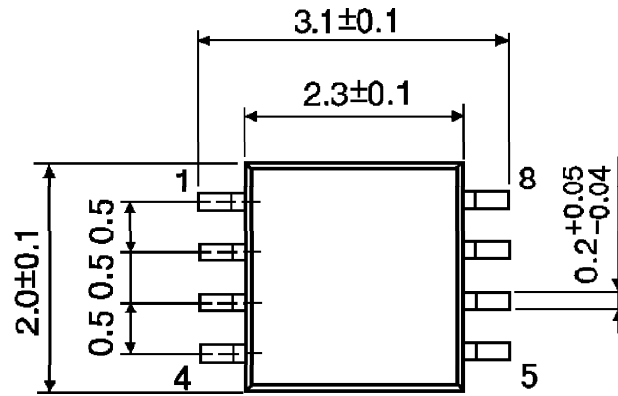

Weight : 0.01g (Typ.)