

Optocoupler, Phototransistor Output, SOP-6L5, Half Pitch, Long Mini-Flat Package

Features

- SMD Low profile 5 pin package
- Isolation Test Voltage 5000 V_{RMS}
- CTR flexibility available see order information
- Special construction
- Extra low coupling capacitance
- Connected base
- DC input with transistor output
- Lead-free component
- Component in accordance to RoHS 2002/95/EC and WEEE 2002/96/EC

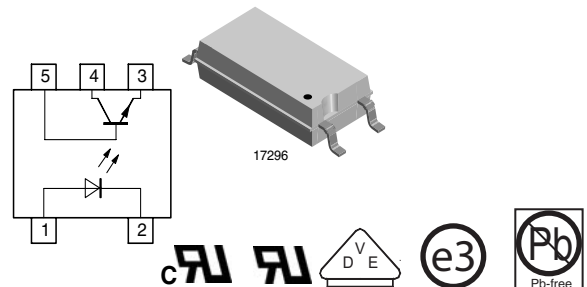

Agency Approvals

- UL1577, File No. E76222 System Code W, Double Protection
- CSA 93751
- BSI IEC60950 IEC60065
- DIN EN 60747-5-2 (VDE0884)
DIN EN 60747-5-5 pending
- FIMKO
- NOTE:
See the Safety Standard Approval List "Agency Table" for more detailed information.

Applications

Switchmode power supplies
Computer peripheral interface
Microprocessor system interface

Description

The TCLT11.. Series consists of a phototransistor optically coupled to a gallium arsenide infrared-emitting diode in a 5-lead SOP5L package.

The elements are mounted on one leadframe providing a fixed distance between input and output for highest safety requirements.

Order Information

Part	Remarks
TCLT1100	CTR 50 - 600 %, SMD-5
TCLT1102	CTR 63 - 125 %, SMD-5
TCLT1103	CTR 100 - 200 %, SMD-5
TCLT1105	CTR 50 - 150 %, SMD-5
TCLT1106	CTR 100 - 300 %, SMD-5
TCLT1107	CTR 80 - 160 %, SMD-5
TCLT1108	CTR 130 - 260 %, SMD-5
TCLT1109	CTR 200 - 400 %, SMD-5

NOTE: Available only on tape and reel.

Absolute Maximum Ratings

$T_{amb} = 25\text{ }^{\circ}\text{C}$, unless otherwise specified

Stresses in excess of the absolute Maximum Ratings can cause permanent damage to the device. Functional operation of the device is not implied at these or any other conditions in excess of those given in the operational sections of this document. Exposure to absolute Maximum Rating for extended periods of the time can adversely affect reliability.

Input

Parameter	Test condition	Symbol	Value	Unit
Reverse voltage		V_R	6	V
Forward current		I_F	60	mA
Forward surge current	$t_p \leq 10\text{ }\mu\text{s}$	I_{FSM}	1.5	A
Power dissipation		P_{diss}	100	mW
Junction temperature		T_j	125	$^{\circ}\text{C}$

Output

Parameter	Test condition	Symbol	Value	Unit
Collector emitter voltage		V_{CEO}	70	V
Emitter collector voltage		V_{ECO}	7	V
Collector current		I_C	50	mA
Collector peak current	$t_p/T = 0.5, t_p \leq 10\text{ ms}$	I_{CM}	100	mA
Power dissipation		P_{diss}	150	mW
Junction temperature		T_j	125	$^{\circ}\text{C}$

Coupler

Parameter	Test condition	Symbol	Value	Unit
Isolation test voltage (RMS)		V_{ISO}	5000	V_{RMS}
Total power dissipation		P_{tot}	250	mW
Operating ambient temperature range		T_{amb}	- 40 to + 100	$^{\circ}\text{C}$
Storage temperature range		T_{stg}	- 40 to + 100	$^{\circ}\text{C}$
Soldering temperature		T_{sld}	240	$^{\circ}\text{C}$

Electrical Characteristics

$T_{amb} = 25\text{ }^{\circ}\text{C}$, unless otherwise specified

Minimum and maximum values are testing requirements. Typical values are characteristics of the device and are the result of engineering evaluation. Typical values are for information only and are not part of the testing requirements.

Input

Parameter	Test condition	Symbol	Min	Typ.	Max	Unit
Forward voltage	$I_F = \pm 50\text{ mA}$	V_F		1.25	1.6	V
Junction capacitance	$V_R = 0\text{ V}, f = 1\text{ MHz}$	C_j		50		pF

Output

Parameter	Test condition	Symbol	Min	Typ.	Max	Unit
Collector emitter voltage	$I_C = 1\text{ mA}$	V_{CEO}	70			V
Emitter collector voltage	$I_E = 100\text{ }\mu\text{A}$	V_{ECO}	7			V
Collector-emitter cut-off current	$V_{CE} = 20\text{ V}, I_f = 0, E = 0$	I_{CEO}		10	100	nA

Coupler

Parameter	Test condition	Symbol	Min	Typ.	Max	Unit
Collector emitter saturation voltage	$I_F = 10 \text{ mA}$, $I_C = 1 \text{ mA}$	V_{CEsat}			0.3	V
Cut-off frequency	$V_{CE} = 5 \text{ V}$, $I_F = 10 \text{ mA}$, $R_L = 100 \Omega$	f_c		110		kHz
Coupling capacitance	$f = 1 \text{ MHz}$	C_k		0.3		pF

Current Transfer Ratio

Parameter	Test condition	Part	Symbol	Min	Typ.	Max	Unit
I_C/I_F	$V_{CE} = 5 \text{ V}$, $I_F = 5 \text{ mA}$	TCLT1100	CTR	50		600	%
		TCLT1102	CTR	63		125	%
	$V_{CE} = 5 \text{ V}$, $I_F = 10 \text{ mA}$	TCLT1103	CTR	100		200	%
		TCLT1102	CTR	22	45		%
		TCLT1103	CTR	34	70		%
	$V_{CE} = 5 \text{ V}$, $I_F = 1 \text{ mA}$	TCLT1104	CTR	56	100		%
		TCLT1105	CTR	50		150	%
		TCLT1106	CTR	100		300	%
	$V_{CE} = 5 \text{ V}$, $I_F = 5 \text{ mA}$	TCLT1107	CTR	80		160	%
		TCLT1108	CTR	130		260	%
		TCLT1109	CTR	200		400	%

Maximum Safety Ratings

(according to DIN EN 60747-5-2(VDE0884)/ DIN EN 60747-5-5 pending) see figure 1

This optocoupler is suitable for safe electrical isolation only within the safety ratings.

Compliance with the safety ratings shall be ensured by means of suitable protective circuits.

Input

Parameter	Test condition	Symbol	Min	Typ.	Max	Unit
Forward current		I_F			130	mA

Output

Parameter	Test condition	Symbol	Min	Typ.	Max	Unit
Power dissipation		P_{diss}			265	mW

Coupler

Parameter	Test condition	Symbol	Min	Typ.	Max	Unit
Rated impulse voltage		V_{IOTM}			8	kV
Safety temperature		T_{si}			150	°C

Insulation Rated Parameters

Parameter	Test condition	Symbol	Min	Typ.	Max	Unit
Partial discharge test voltage - Routine test	100 %, $t_{\text{test}} = 1 \text{ s}$	V_{pd}	1.6			kV
Partial discharge test voltage - Lot test (sample test)	$t_{\text{Tr}} = 60 \text{ s}$, $t_{\text{test}} = 10 \text{ s}$, (see figure 2)	V_{IOTM}	8			kV
		V_{pd}	1.3			kV
Insulation resistance	$V_{\text{IO}} = 500 \text{ V}$	R_{IO}	10^{12}			Ω
	$V_{\text{IO}} = 500 \text{ V}$, $T_{\text{amb}} = 100 \text{ }^\circ\text{C}$	R_{IO}	10^{11}			Ω
	$V_{\text{IO}} = 500 \text{ V}$, $T_{\text{amb}} = 150 \text{ }^\circ\text{C}$ (construction test only)	R_{IO}	10^9			Ω

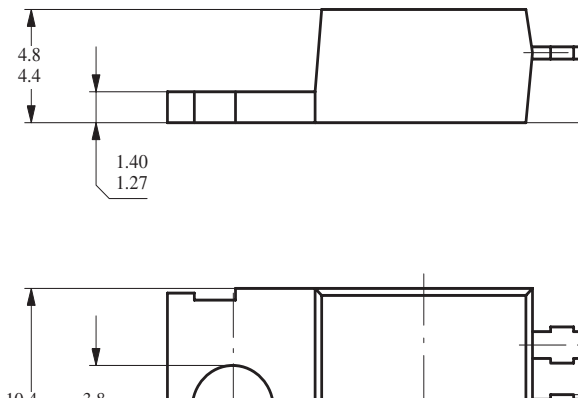

Figure 1. Derating diagram

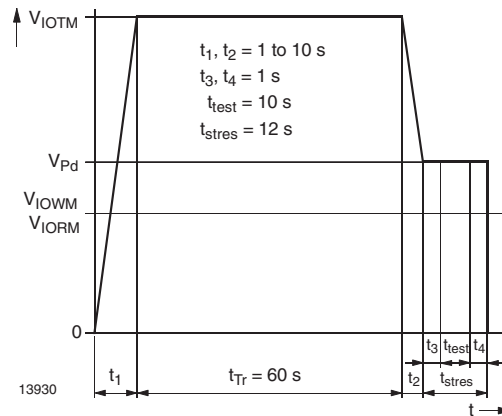

Figure 2. Test pulse diagram for sample test according to DIN EN 60747-5-2(VDE0884)/ DIN EN 60747-; IEC60747

Switching Characteristics

Parameter	Test condition	Symbol	Min	Typ.	Max	Unit
Delay time	$V_S = 5\text{ V}$, $I_C = 2\text{ mA}$, $R_L = 100\ \Omega$ (see figure 3)	t_d		3.0		μS
Rise time	$V_S = 5\text{ V}$, $I_C = 2\text{ mA}$, $R_L = 100\ \Omega$ (see figure 3)	t_r		3.0		μS
Turn-on time	$V_S = 5\text{ V}$, $I_C = 2\text{ mA}$, $R_L = 100\ \Omega$ (see figure 3)	t_{on}		6.0		μS
Storage time	$V_S = 5\text{ V}$, $I_C = 2\text{ mA}$, $R_L = 100\ \Omega$ (see figure 3)	t_s		0.3		μS
Fall time	$V_S = 5\text{ V}$, $I_C = 2\text{ mA}$, $R_L = 100\ \Omega$ (see figure 3)	t_f		4.7		μS
Turn-off time	$V_S = 5\text{ V}$, $I_C = 2\text{ mA}$, $R_L = 100\ \Omega$ (see figure 3)	t_{off}		5.0		μS
Turn-on time	$V_S = 5\text{ V}$, $I_F = 10\text{ mA}$, $R_L = 1\text{ k}\Omega$ (see figure 4)	t_{on}		9.0		μS
Turn-off time	$V_S = 5\text{ V}$, $I_F = 10\text{ mA}$, $R_L = 1\text{ k}\Omega$ (see figure 4)	t_{off}		10.0		μS



Figure 3. Test circuit, non-saturated operation



Figure 5. Switching Times



Figure 4. Test circuit, saturated operation

Typical Characteristics ($T_{amb} = 25\text{ }^{\circ}\text{C}$ unless otherwise specified)

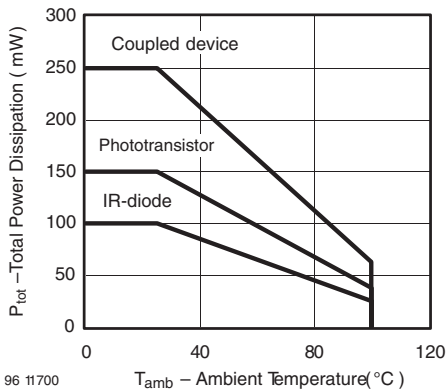

Figure 6. Total Power Dissipation vs. Ambient Temperature

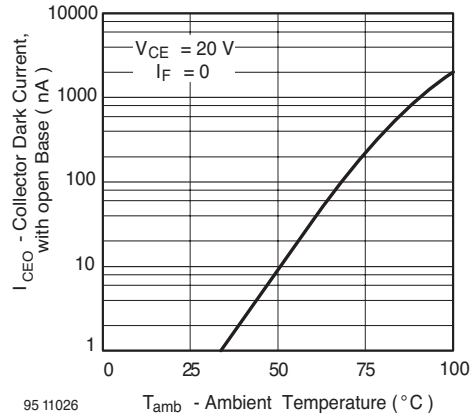

Figure 9. Collector Dark Current vs. Ambient Temperature

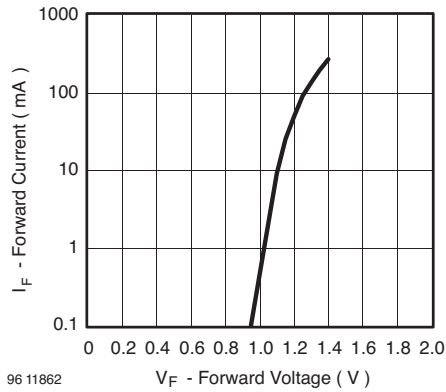

Figure 7. Forward Current vs. Forward Voltage

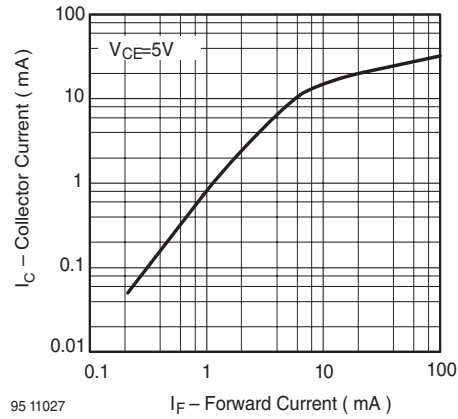

Figure 10. Collector Current vs. Forward Current

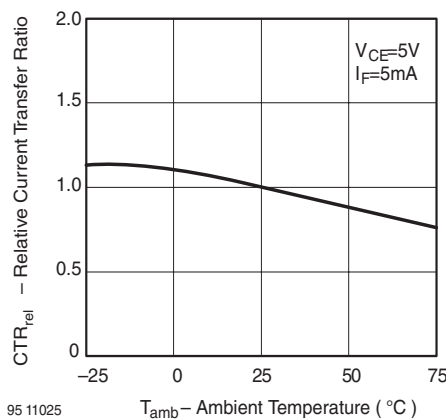

Figure 8. Relative Current Transfer Ratio vs. Ambient Temperature

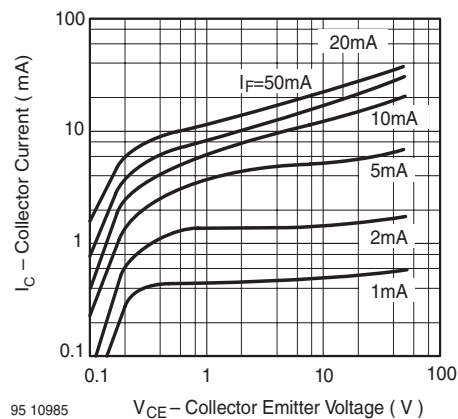
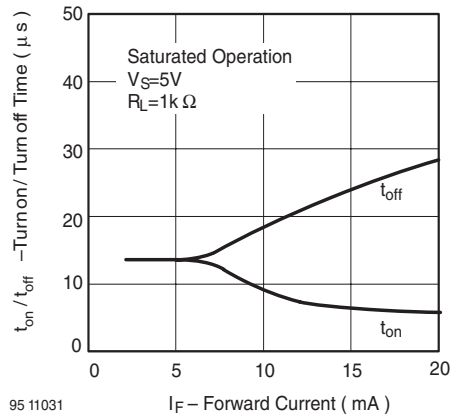

Figure 11. Collector Current vs. Collector Emitter Voltage



95 11028

Figure 12. Collector Emitter Saturation Voltage vs. Collector Current



95 11031

Figure 15. Turn on / off Time vs. Forward Current

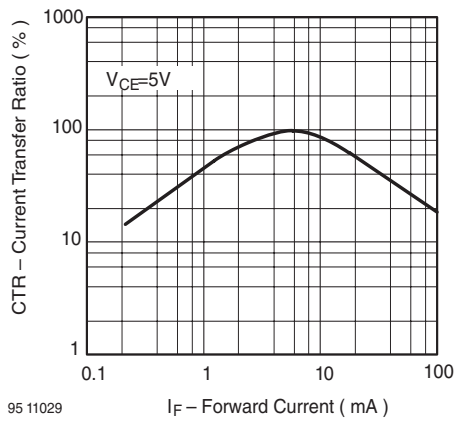

95 11029

Figure 13. Current Transfer Ratio vs. Forward Current

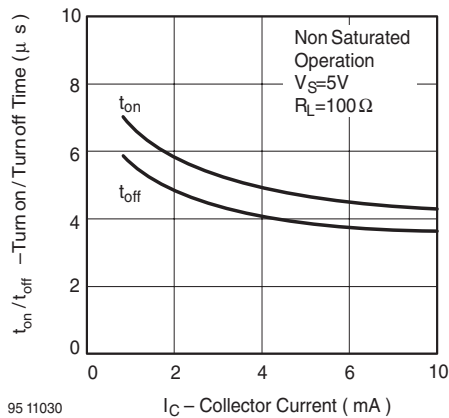

95 11030

Figure 14. Turn on / off Time vs. Collector Current

Package Dimensions in mm

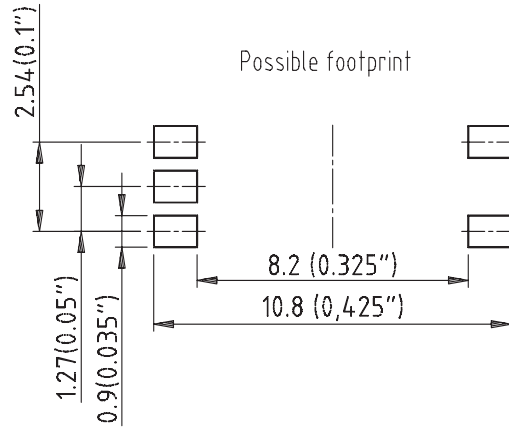
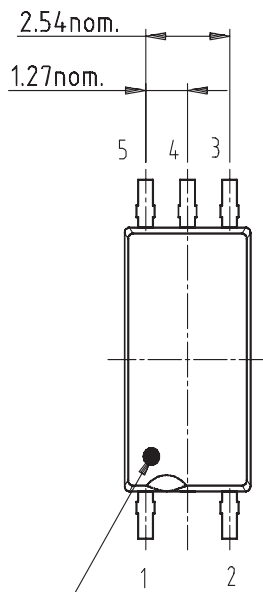
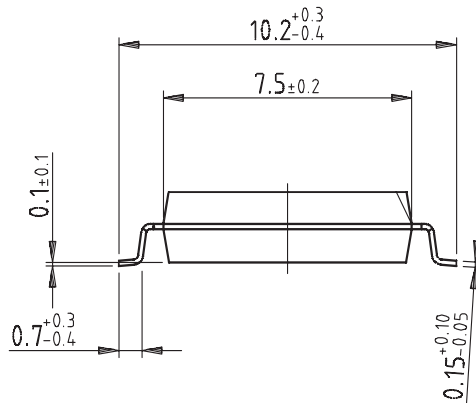
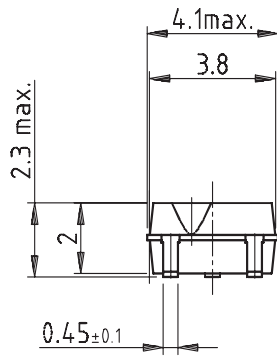

Pin no. 1 identification

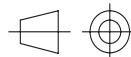

Technical drawings according to DIN specifications

15227

Drawing-No.: 6.544-5331.02-4

Issue: 2; 29.06.00



Ozone Depleting Substances Policy Statement

It is the policy of Vishay Semiconductor GmbH to

1. Meet all present and future national and international statutory requirements.
2. Regularly and continuously improve the performance of our products, processes, distribution and operating systems with respect to their impact on the health and safety of our employees and the public, as well as their impact on the environment.

It is particular concern to control or eliminate releases of those substances into the atmosphere which are known as ozone depleting substances (ODSs).

The Montreal Protocol (1987) and its London Amendments (1990) intend to severely restrict the use of ODSs and forbid their use within the next ten years. Various national and international initiatives are pressing for an earlier ban on these substances.

Vishay Semiconductor GmbH has been able to use its policy of continuous improvements to eliminate the use of ODSs listed in the following documents.

1. Annex A, B and list of transitional substances of the Montreal Protocol and the London Amendments respectively
2. Class I and II ozone depleting substances in the Clean Air Act Amendments of 1990 by the Environmental Protection Agency (EPA) in the USA
3. Council Decision 88/540/EEC and 91/690/EEC Annex A, B and C (transitional substances) respectively.

Vishay Semiconductor GmbH can certify that our semiconductors are not manufactured with ozone depleting substances and do not contain such substances.

We reserve the right to make changes to improve technical design and may do so without further notice.

Parameters can vary in different applications. All operating parameters must be validated for each customer application by the customer. Should the buyer use Vishay Semiconductors products for any unintended or unauthorized application, the buyer shall indemnify Vishay Semiconductors against all claims, costs, damages, and expenses, arising out of, directly or indirectly, any claim of personal damage, injury or death associated with such unintended or unauthorized use.

Vishay Semiconductor GmbH, P.O.B. 3535, D-74025 Heilbronn, Germany
Telephone: 49 (0)7131 67 2831, Fax number: 49 (0)7131 67 2423