

TOSHIBA BIPOLAR DIGITAL INTEGRATED CIRCUIT SILICON MONOLITHIC

TD62583AP, TD62583F, TD62583AF

8CH SINGLE DRIVER

The TD62583AP/F/AF have a 2.7kΩ series base resistor, and thus allows operation directly with TTL or CMOS operating at supply voltage of 5V.

Applications include relay, hammer, lamp and display (LED) drivers.

FEATURES

- Output current (single output) 50mA (Max.)
- High sustaining voltage output 35V (Min.) (TD62583F)
50V (Min.) (TD62583AP / AF)
- Low saturation voltage $V_{CE(sat)} = 0.4V @ I_C = 16mA$
- Inputs compatible with TTL, 5V CMOS
- Package type-AP : DIP-18 pin
- Package type-F, AF : SOP-18 pin

PIN CONNECTION (TOP VIEW)

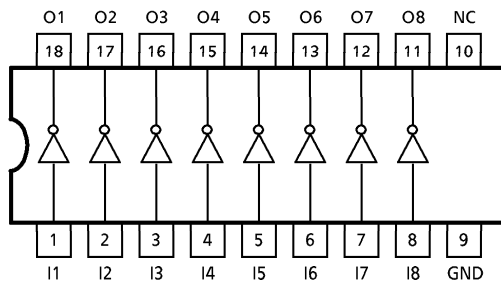

SCHEMATICS (EACH DRIVER)

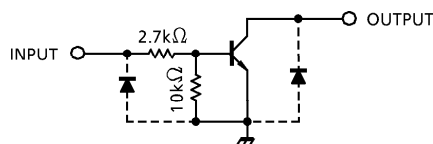

(Note) The input and output parasitic diodes cannot be used as clamp diodes.

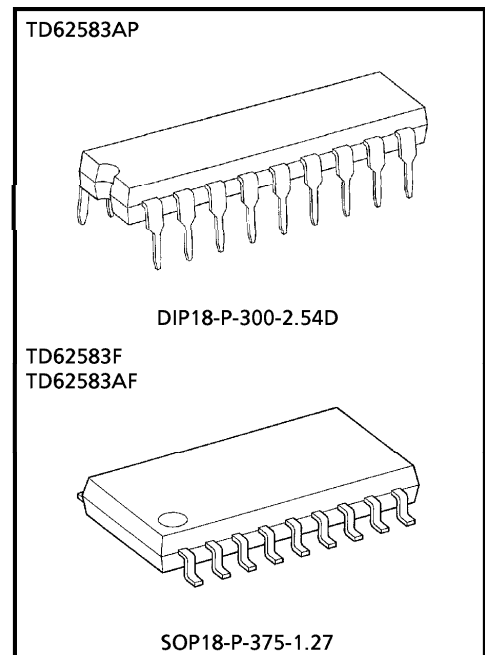

Weight
 DIP18-P-300-2.54D : 1.47g (Typ.)
 SOP18-P-375-1.27 : 0.41g (Typ.)

961001EBA2

- TOSHIBA is continually working to improve the quality and the reliability of its products. Nevertheless, semiconductor devices in general can malfunction or fail due to their inherent electrical sensitivity and vulnerability to physical stress. It is the responsibility of the buyer, when utilizing TOSHIBA products, to observe standards of safety, and to avoid situations in which a malfunction or failure of a TOSHIBA product could cause loss of human life, bodily injury or damage to property. In developing your designs, please ensure that TOSHIBA products are used within specified operating ranges as set forth in the most recent products specifications. Also, please keep in mind the precautions and conditions set forth in the TOSHIBA Semiconductor Reliability Handbook.
- The products described in this document are subject to foreign exchange and foreign trade control laws.
- The information contained herein is presented only as a guide for the applications of our products. No responsibility is assumed by TOSHIBA CORPORATION for any infringements of intellectual property or other rights of the third parties which may result from its use. No license is granted by implication or otherwise under any intellectual property or other rights of TOSHIBA CORPORATION or others.
- The information contained herein is subject to change without notice.

MAXIMUM RATINGS (Ta = 25°C)

CHARACTERISTIC		SYMBOL	RATING	UNIT
Output Sustaining Voltage	AP, AF	V _{CEO}	50	V
	F		35	
Output Current		I _{OUT}	50	mA / ch
Input Voltage		V _{IN}	10	V
Power Dissipation	AP	P _D	1.47	W
	F, AF		0.96	
Operating Temperature		T _{opr}	-40~85	°C
Storage Temperature		T _{stg}	-55~150	°C

RECOMMENDED OPERATING CONDITIONS (Ta = -40~85°C)

CHARACTERISTIC		SYMBOL	CONDITION	MIN.	TYP.	MAX.	UNIT
Output Sustaining Voltage	AP, AF	V _{CEO}	—	0	—	50	V
	F		—	0	—	35	
Output Current		I _{OUT}	—	0	—	30	mA / ch
Input Voltage		V _{IN}	—	0	—	7	V
	Output On	V _{IN (ON)}	—	3.5	—	7	
Power Dissipation	AP	P _D	—	—	—	0.52	W
	F, AF		—	—	—	0.4	

ELECTRICAL CHARACTERISTICS (Ta = 25°C)

CHARACTERISTIC		SYMBOL	TEST CIRCUIT	TEST CONDITION	MIN.	TYP.	MAX.	UNIT
Output Leakage Current	AP, AF	I _{CEX}	1	V _{CE} = 50V	—	—	10	μA
	F			V _{CE} = 35V			10	
Output Saturation Voltage	V _{CE (sat)}		2	I _C = 16mA, I _{IN} = 0.3mA	—	0.2	0.4	V
				I _C = 30mA, I _{IN} = 0.45mA			0.7	
DC Current Transfer Ratio		h _{FE}	2	V _{CE} = 4V, I _C = 30mA	70	130	—	—
Input Current		I _{IN (ON)}	3	V _{IN} = 2.5V, I _C = 16mA	—	0.65	1.7	mA
Turn-On Delay	F	t _{ON}	4	V _{OUT} = 35V, R _L = 0.87kΩ	—	0.1	—	μs
	AP, AF			V _{OUT} = 50V, R _L = 1.25kΩ			—	
Turn-Off Delay	F	t _{OFF}		V _{OUT} = 35V, R _L = 0.87kΩ	—	0.5	—	
	AP, AF			V _{OUT} = 50V, R _L = 1.25kΩ			—	

TEST CIRCUIT

1. I_{CEX}

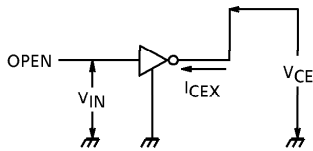

2. h_{FE} , $V_{CE(sat)}$

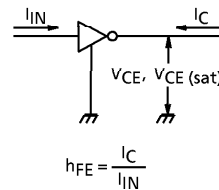

3. $V_{IN(ON)}$

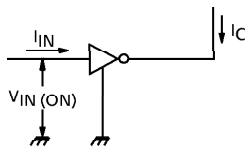

4. t_{ON} , t_{OFF}

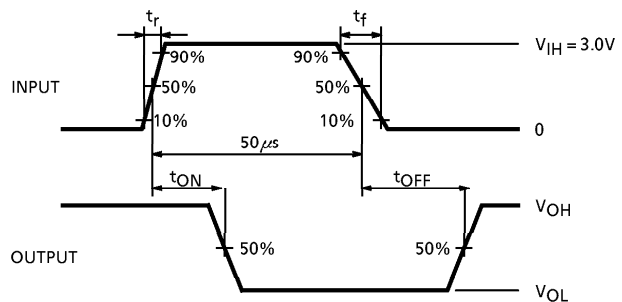
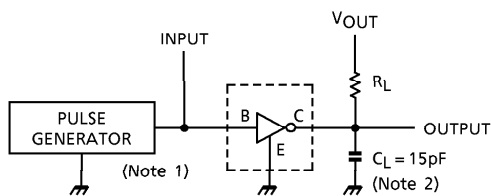

(Note 1) Pulse Width $50\mu s$, Duty Cycle 10%
Output Impedance 50Ω , $t_r \leq 5ns$, $t_f \leq 10ns$
(Note 2) C_L includes probe and jig capacitance.

PRECAUTIONS for USING

Utmost care is necessary in the design of the output line, V_{CC} and GND line since IC may be destroyed due to short-circuit between outputs, air contamination fault, or fault by improper grounding.

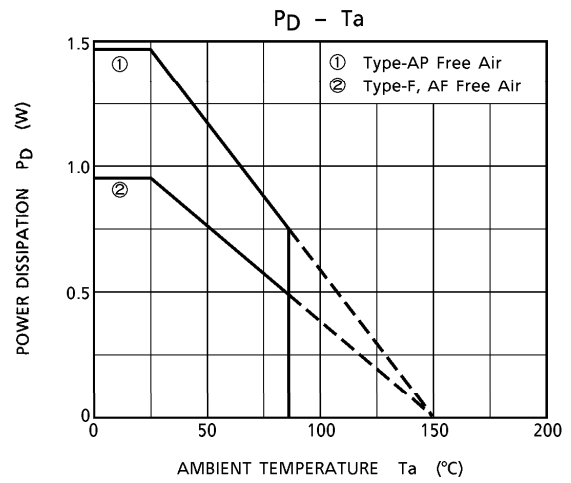
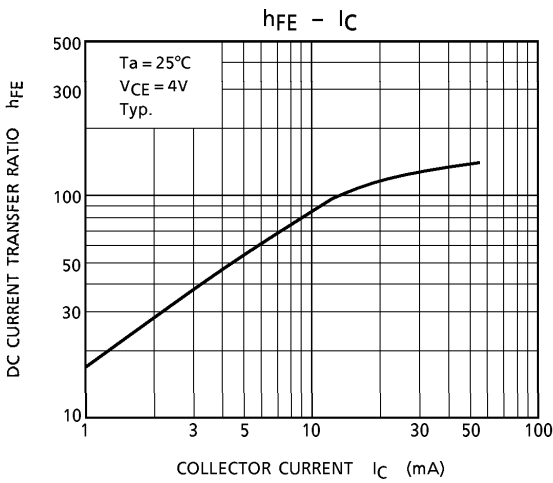
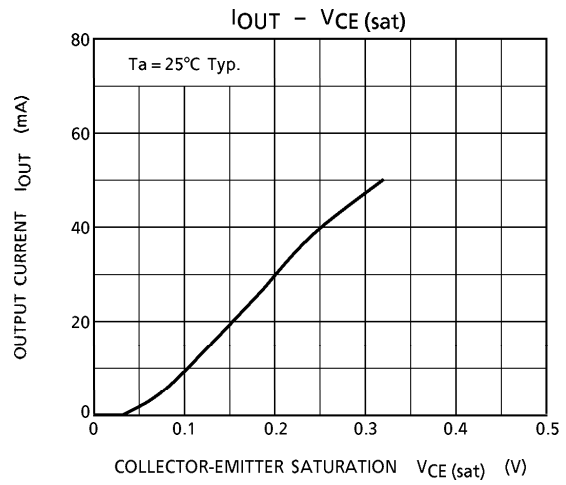
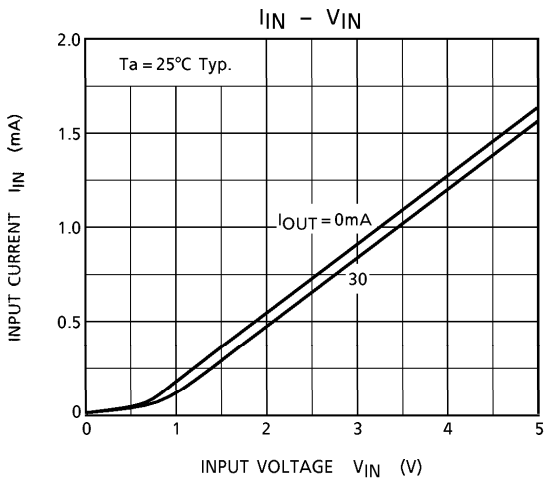

OUTLINE DRAWING
DIP18-P-300-2.54D

Unit : mm

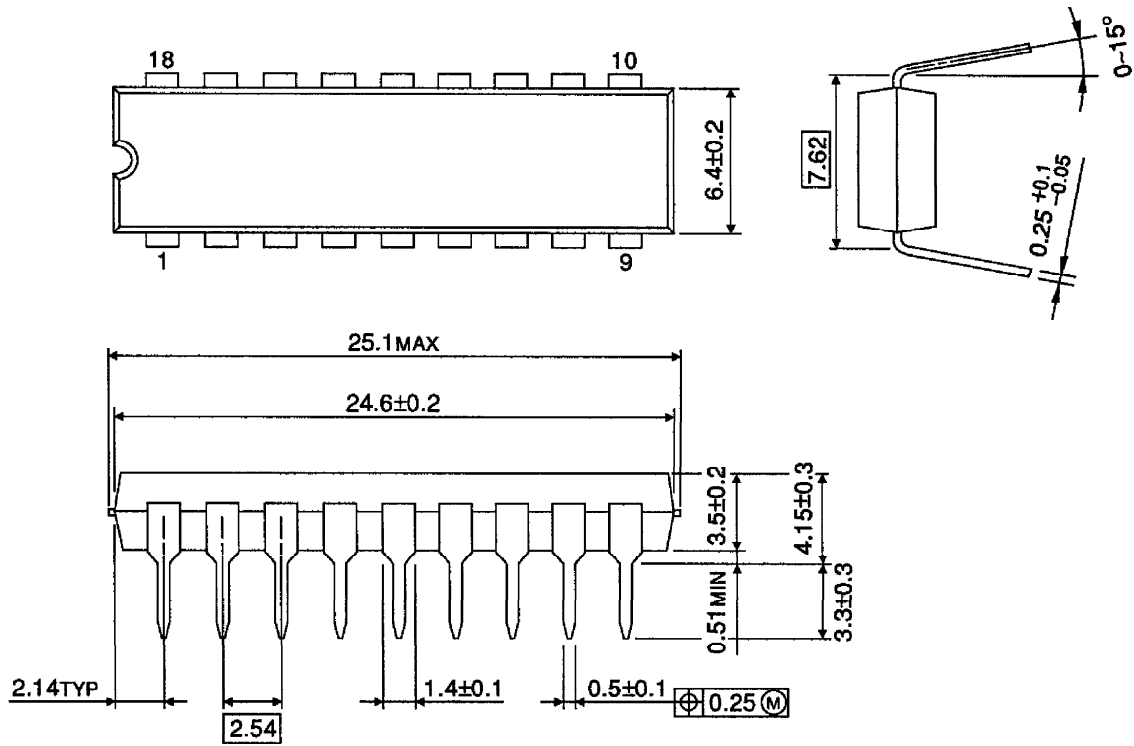

Weight : 1.47g (Typ.)

OUTLINE DRAWING
SOP18-P-375-1.27

Unit : mm

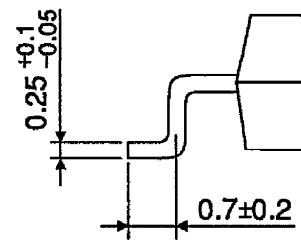
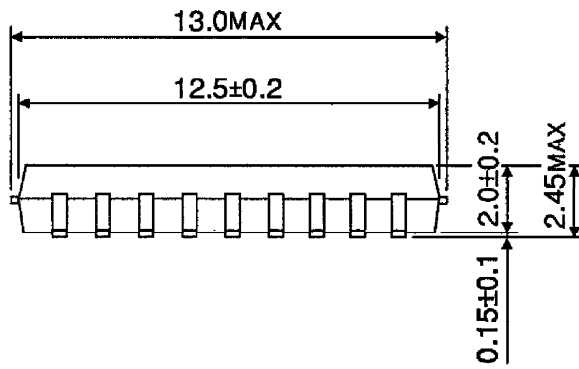
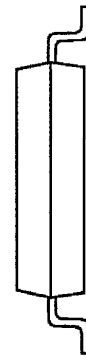
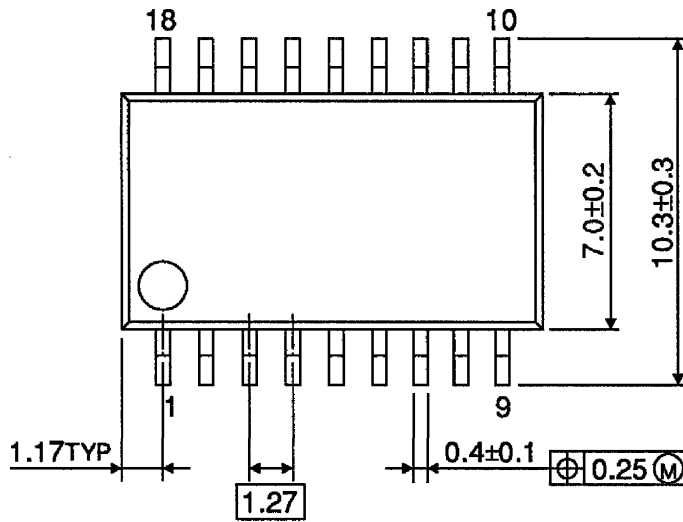

Weight : 0.41g (Typ.)