

Ku Band 2 Watt Packaged Amplifier

TGA2904-FL



Key Features and Performance

- Frequency Range: 13-17 GHz
- Optimized for VSAT band (13.75-14.5 GHz)
- 33 dB Nominal Gain
- Typical > 33.5 dBm Psat in VSAT band @ 7V
- Bias 5-8 V @ 680 mA (Quiescent)
- 0.5- μ m pHEMT 3MI Technology
- 10 lead flange packaged
- Package dimensions: 0.70x 0.33 x 0.1 in³

Primary Applications

- VSAT
- Point to Point

Product Description

The TriQuint TGA2904-FL is a compact 2 Watt High Power Amplifier Packaged MMIC for Ku-band applications. The packaged part provides 33 dB nominal gain.

The part is ideally suited for low cost emerging markets such as base station transmitters for satellite ground terminals and point to point radio.

The TGA2904-FL is 100% RF tested to ensure performance compliance.

Lead-Free & RoHS compliant.

Evaluation boards are available.

Preliminary Measured Performance

Bias Conditions: $V_d = 7\text{ V}$, $I_{dq} = 680\text{ mA}$

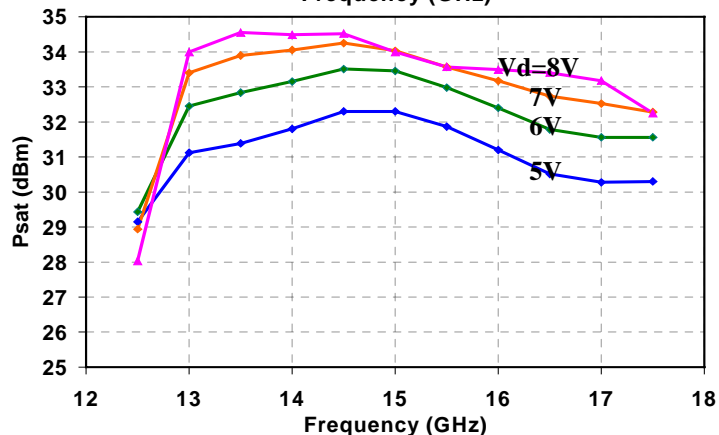
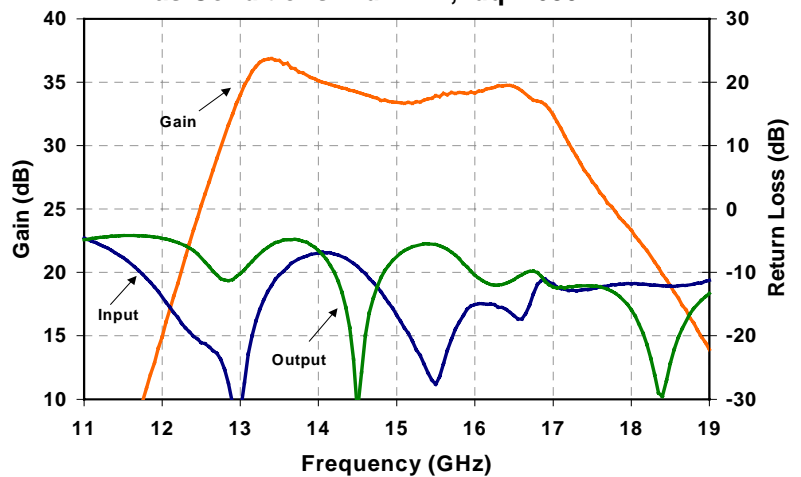

Note: This device is early in the characterization process prior to finalizing all electrical specifications. Specifications are subject to change without notice.

TABLE I
MAXIMUM RATINGS 1/

Symbol	Parameter	Value	Notes
V _d	Drain Supply Voltage	8 V	<u>2/</u>
V _g	Gate Supply Voltage Range	-5V to 0V	
I _{dq}	Drain Supply Current (Quiescent)	1.3 A	<u>2/</u>
I _g	Gate Current	18 mA	
P _{IN}	Input Continuous Wave Power	21 dBm	<u>2/</u>
P _D	Power Dissipation	5 W + (85°C - T _B)/13	<u>2/ 3/</u>
T _{CH}	Operating Channel Temperature	150 °C	<u>4/ 5/</u>
T _M	Mounting Temperature (30 Seconds)	260 °C	
T _{STG}	Storage Temperature	-65 to 150 °C	

- 1/ These ratings represent the maximum operable values for this device.
- 2/ Combinations of supply voltage, supply current, input power, and output power shall not exceed P_D.
- 3/ T_B = Package backside temperature in degrees C.
- 4/ These ratings apply to each individual FET.
- 5/ Junction operating temperature will directly affect the device median time to failure (T_M). For maximum life, it is recommended that junction temperatures be maintained at the lowest possible levels.

TABLE II
RF CHARACTERIZATION TABLE
(T_A = 25°C, Nominal)
(V_d = 7 V, I_{dq} = 680 mA)

SYMBOL	PARAMETER	TEST CONDITION	TYPICAL	UNITS
Gain	Small Signal Gain	F = 13 –17 GHz	33	dB
IRL	Input Return Loss	F = 13 –17 GHz	10	dB
ORL	Output Return Loss	F = 13 –17 GHz	10	dB
PWR	Output Power @ Pin = +5 dBm	F = 13 –15 GHz	34	dBm

Typical Fixtured Performance

Bias Conditions: $V_d = 7\text{ V}$, $I_{dq} = 680\text{ mA}$

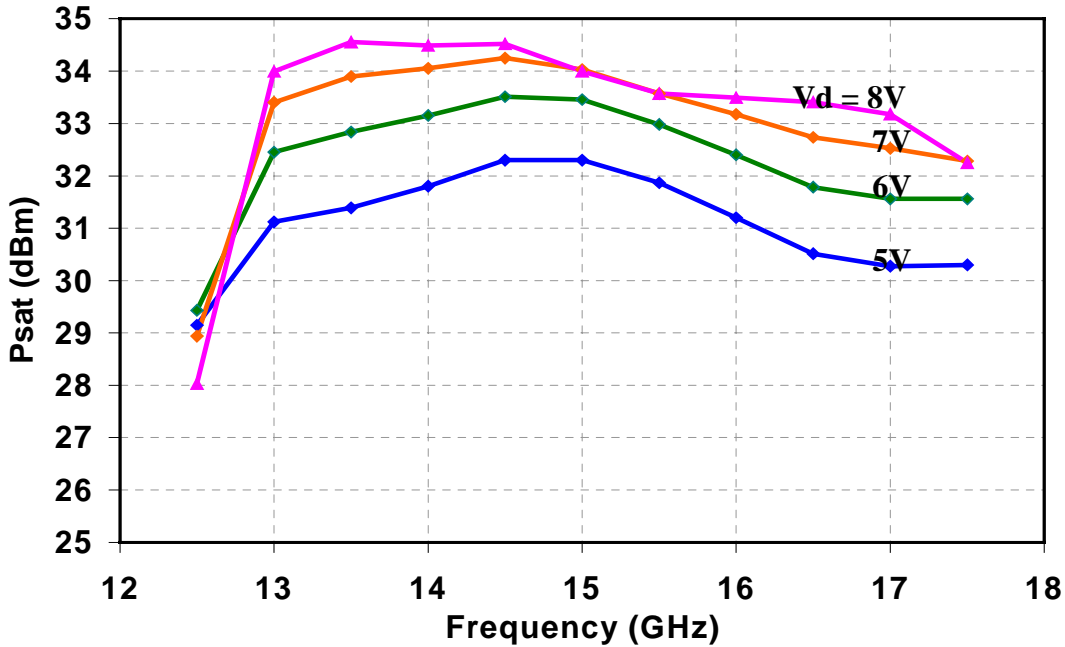
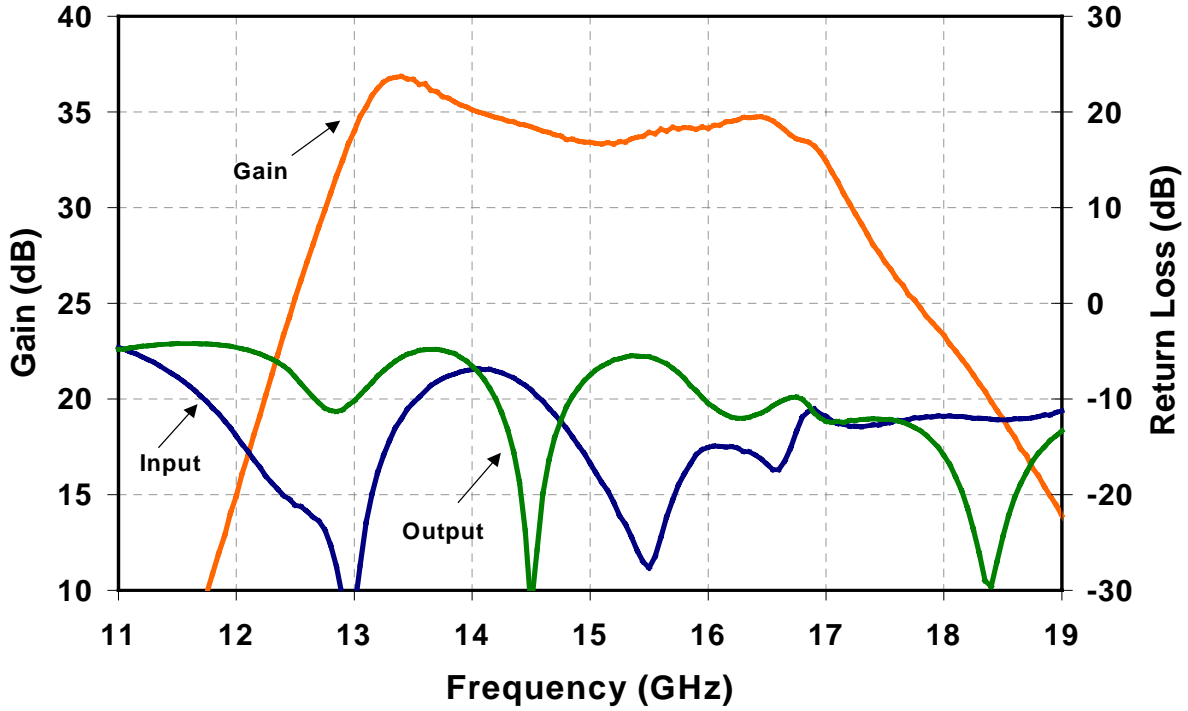

Typical Fixtured Performance

Bias Conditions: $V_d = 7\text{ V}$, $I_{dq} = 680\text{ mA}$, $F = 14\text{ GHz}$

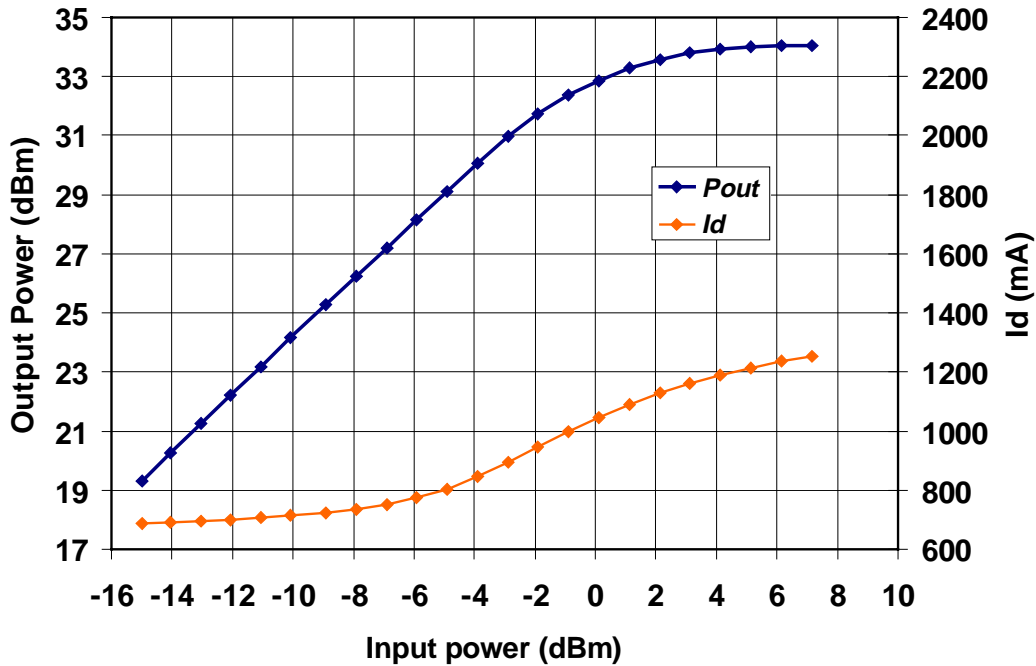

Mechanical Drawing

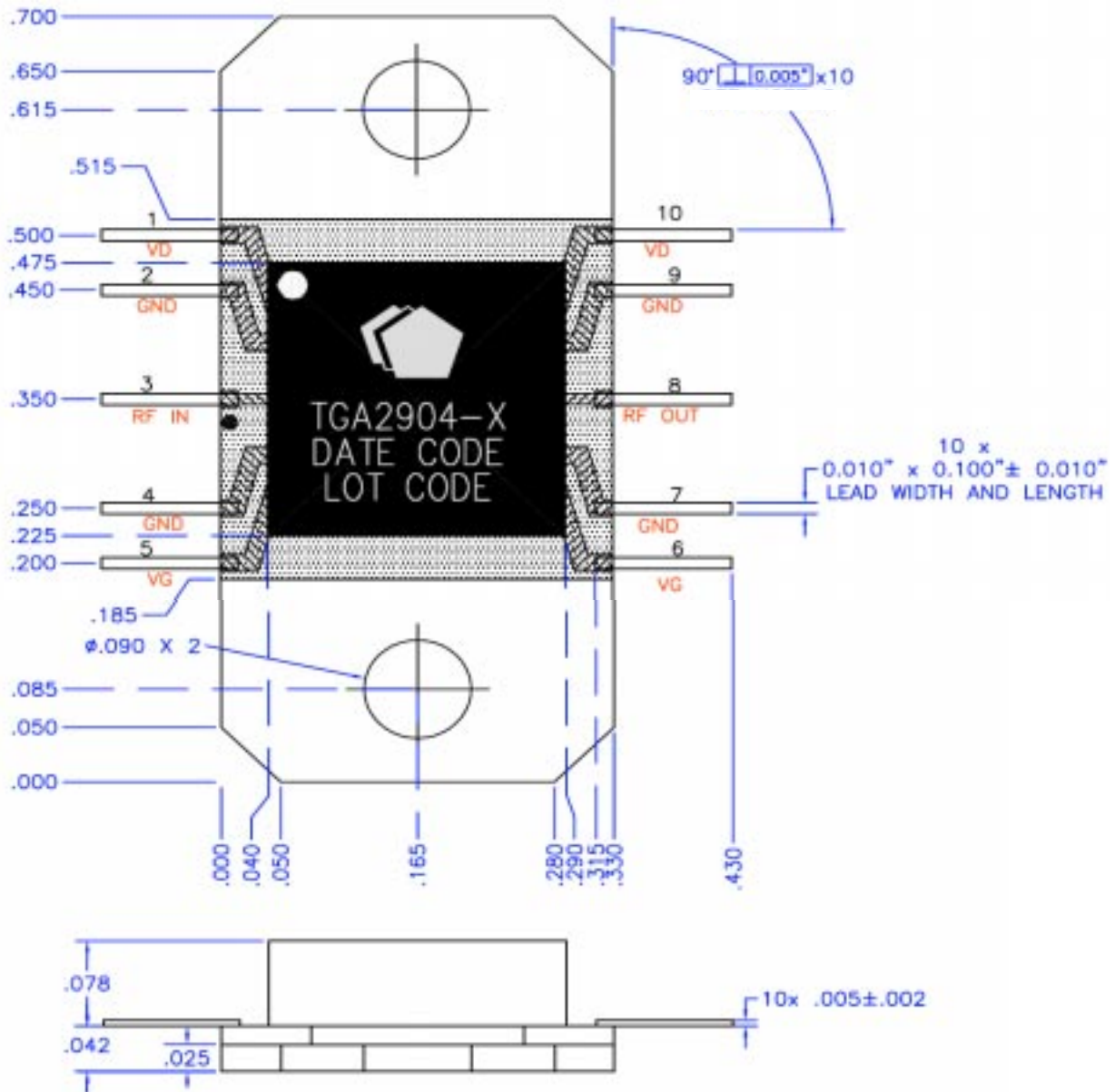

Units: inches
 Tolerance (unless otherwise noted): +/- 0.005

Package Assembly Diagram

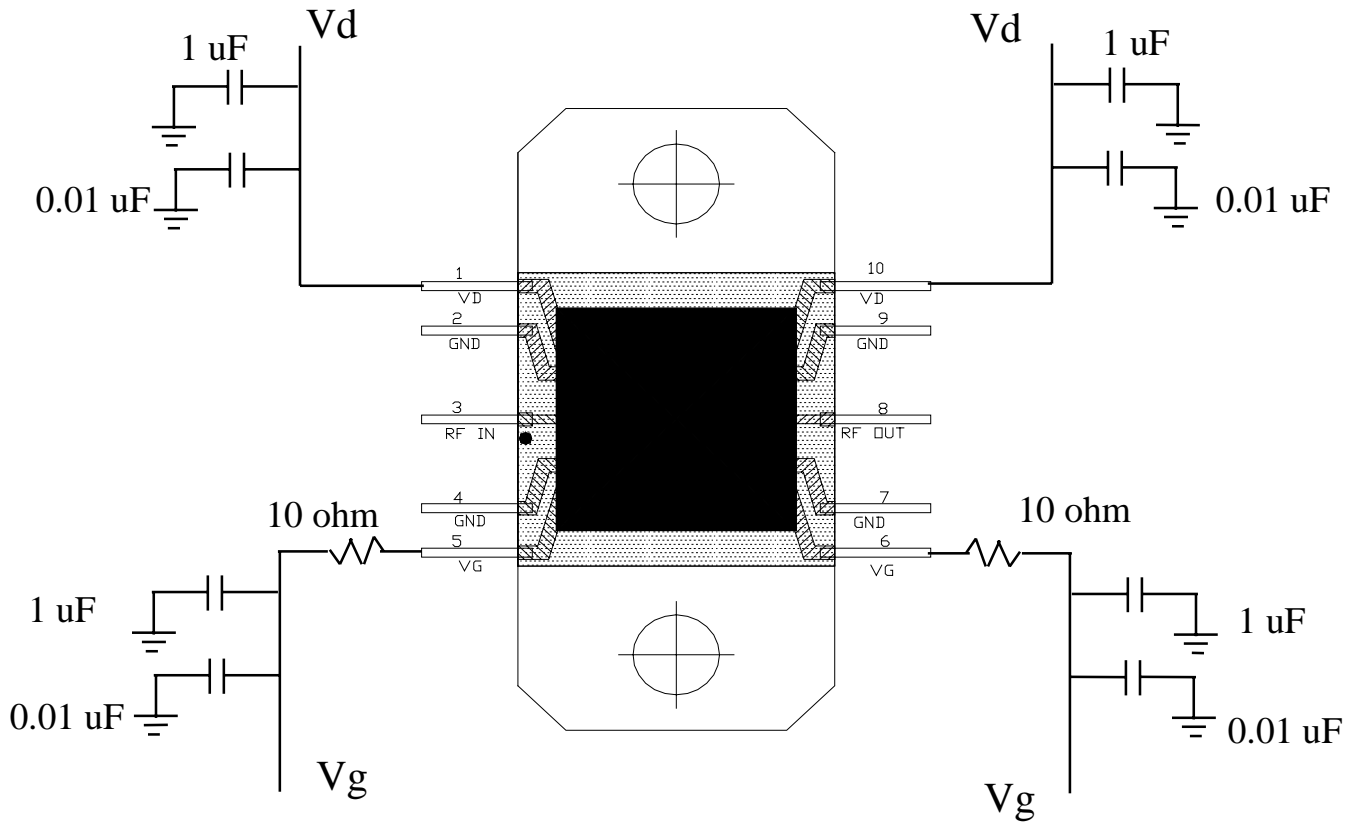

Assembly of a TGA2904-FL Surface Mount Package onto a Motherboard

Manual Assembly for Prototypes

1. Clean the motherboard or the similar module with Acetone. Rinse with alcohol and DI water. Allow the circuit to fully dry.
2. To improve the thermal and RF performance, we recommend a heat sink attach to the bottom of the package and apply indium alloy SN63 solder or Tin Lead solder to the bottom of TGA2904-FL
3. Apply Tin Lead solder to each pin of TGA2904-FL.
4. Clean the assembly with alcohol.

High Volume Assembly of the Package

The TGA2904-FL is a custom leaded packaged component. High volume assembly can be performed using standard assembly processes including solder printing such as stencil solder printing. Pick-and-place using a standard machine such as a MRSI machine, and solder reflow using a "Sikama Reflow System" using typical zone temperatures: 120, 175, 195, and 215 degrees Celsius at 15 second intervals.

Ordering Information

Part	Package Style
TGA2904-FL	Flange Lead

GaAs MMIC devices are susceptible to damage from Electrostatic Discharge. Proper precautions should be observed during handling, assembly and test.