

TEMPERATURE SENSOR IC

FEATURES

- Linear Output Voltage 5 mV/°C Output
- 2.4 to 10.0 V Supply Range
- Miniature Package (SOT-25)
- Minimum External Parts Count
- Low Power Consumption

DESCRIPTION

The TK11043 is a temperature sensor IC with a linear output of 5 mV/°C over the range of -30 to + 105 °C. Its wide operating voltage range of 2.4 to 10.0 V makes it suitable for a number of applications requiring accurate temperature control, such as electronic thermostats for climate control, refrigerators, and industrial process controls.

A typical application is to make a digital representation of temperature with an A/D converter, or to make a thermal detector with a comparator.

The TK11043 has a compensation pin for a 0.1 μF capacitor that ensures stability over the IC's operating temperature range.

The TK11043 is available in a miniature SOT-25 surface mount package.

APPLICATIONS

- Home and Industrial Thermostats
- Automotive Climate Control
- Battery Charger Temperature Monitor
- Notebook Computer Temperature Monitor
- Electronic Thermometers
- Fish Finder Water Temperature
- Industrial Process Controllers
- Home Appliance Temperature Control

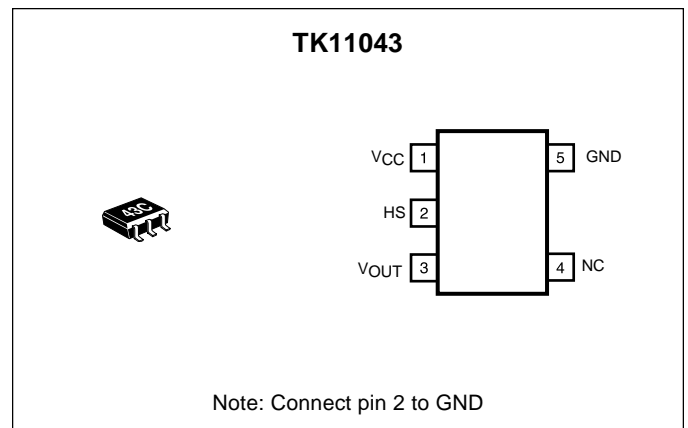

ORDERING INFORMATION	
TK11043M-1	 Tape/Reel Code

TAPE/REEL CODE
TL: Tape Left

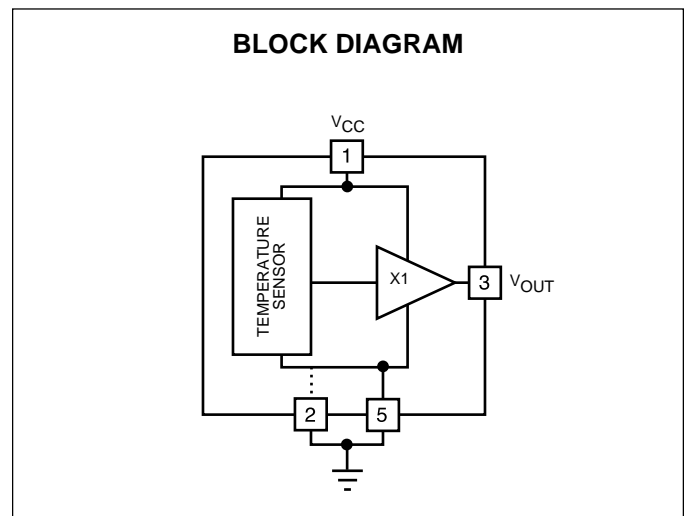

TK11043

ABSOLUTE MAXIMUM RATINGS

Supply Voltage	12 V	Storage Temperature Range	-55 to +150 °C
Operating Voltage	2.4 to 10 V	Operating Temperature Range	-30 to +105 °C
Power Dissipation (Note 1)	150 mW	Lead Soldering Temperature (10 s)	235 °C
Junction Temperature	150 °C		

TK11043 ELECTRICAL CHARACTERISTICS

Test Conditions: $V_{CC} = 3.0\text{ V}$, $I_{OUT} = 0\ \mu\text{A}$, $T_A = 25\ ^\circ\text{C}$, unless otherwise specified.

SYMBOL	PARAMETER	TEST CONDITIONS	MIN	TYP	MAX	UNITS
V_{OUT}	Output Voltage	$T_A = 25\ ^\circ\text{C}$	1.487	1.502	1.517	V
		$T_A = 85\ ^\circ\text{C}$	1.784	1.804	1.824	V
		$T_A = -30\ ^\circ\text{C}$		1.225		V
T_C	Temperature Coefficient	$T_A = 25\ ^\circ\text{C}$ to $85\ ^\circ\text{C}$	4.50	5.04	5.50	mV/°C
Line Reg	Line Regulation	$V_{CC} = 3$ to 10 V	-12	2	12	mV
Load Reg	Load Regulation	$I_{OUT} = 0$ to $100\ \mu\text{A}$	0	2	12	mV
I_{CC}	Supply Current	$T_A = 25\ ^\circ\text{C}$		110	180	μA
I_{OUT}	Output Current	$\Delta V_{OUT} \leq 15\text{ mV}$			400	μA

Note 1: Power dissipation is 150 mW when mounted as recommended. Derate at 1.2 mW/°C for operation above 25 °C.

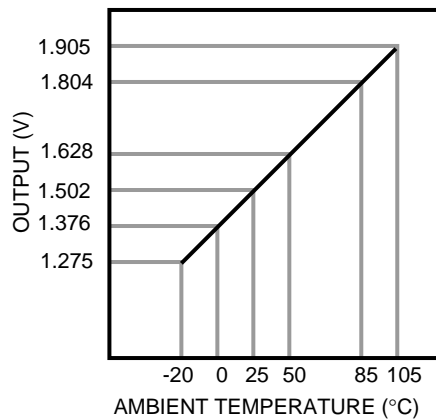
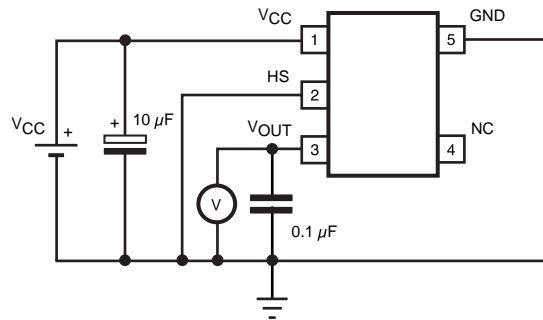

FIGURE 1. OUTPUT CHARACTERISTICS

TEST CIRCUIT



Note: Connect pin 2 to ground

TYPICAL PERFORMANCE CHARACTERISTICS

$V_{CC} = 3\text{ V}$, $T_A = 25\text{ }^\circ\text{C}$, unless otherwise specified.

SUPPLY CURRENT vs. SUPPLY VOLTAGE

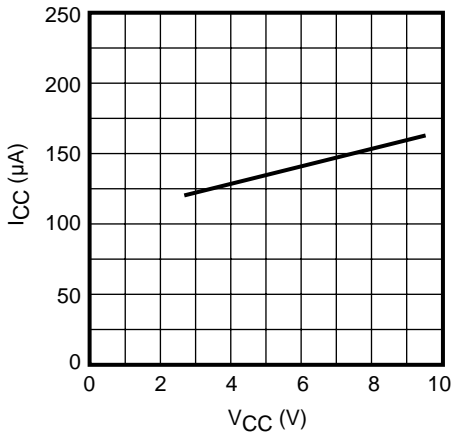

OUTPUT VOLTAGE vs. SUPPLY VOLTAGE

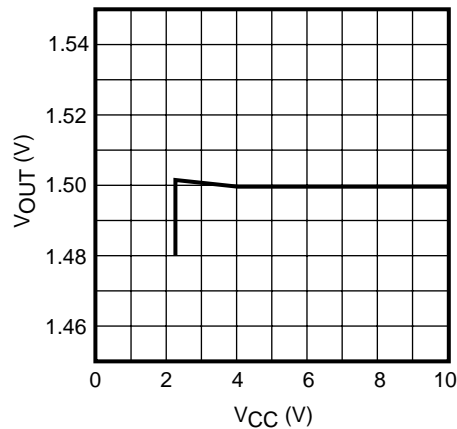

OUTPUT VOLTAGE vs. OUTPUT CURRENT

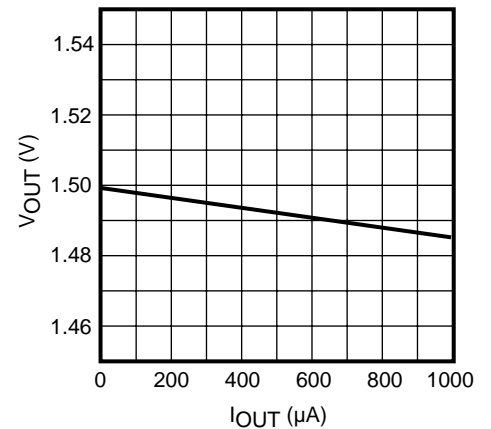

SUPPLY CURRENT vs. TEMPERATURE

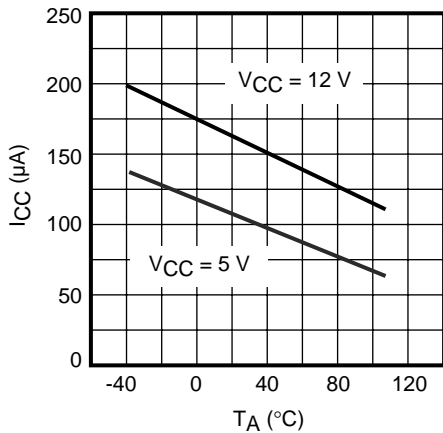

OUTPUT VOLTAGE vs. TEMPERATURE

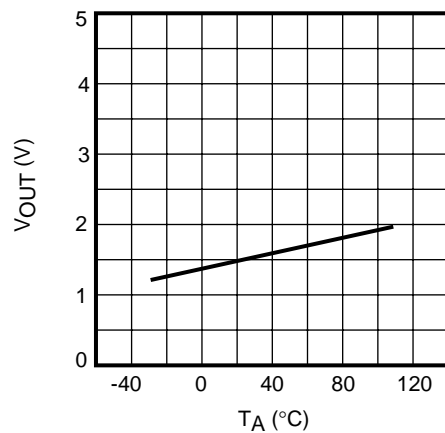

LINEARITY ERROR vs. TEMPERATURE

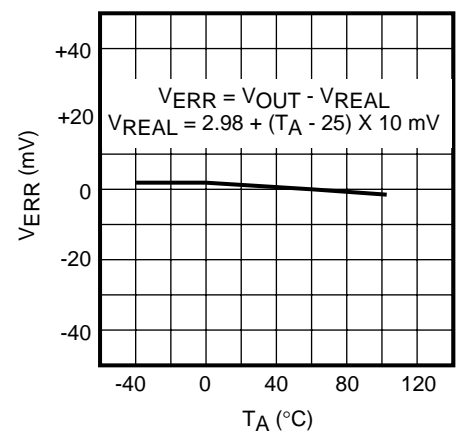

PACKAGE OUTLINE

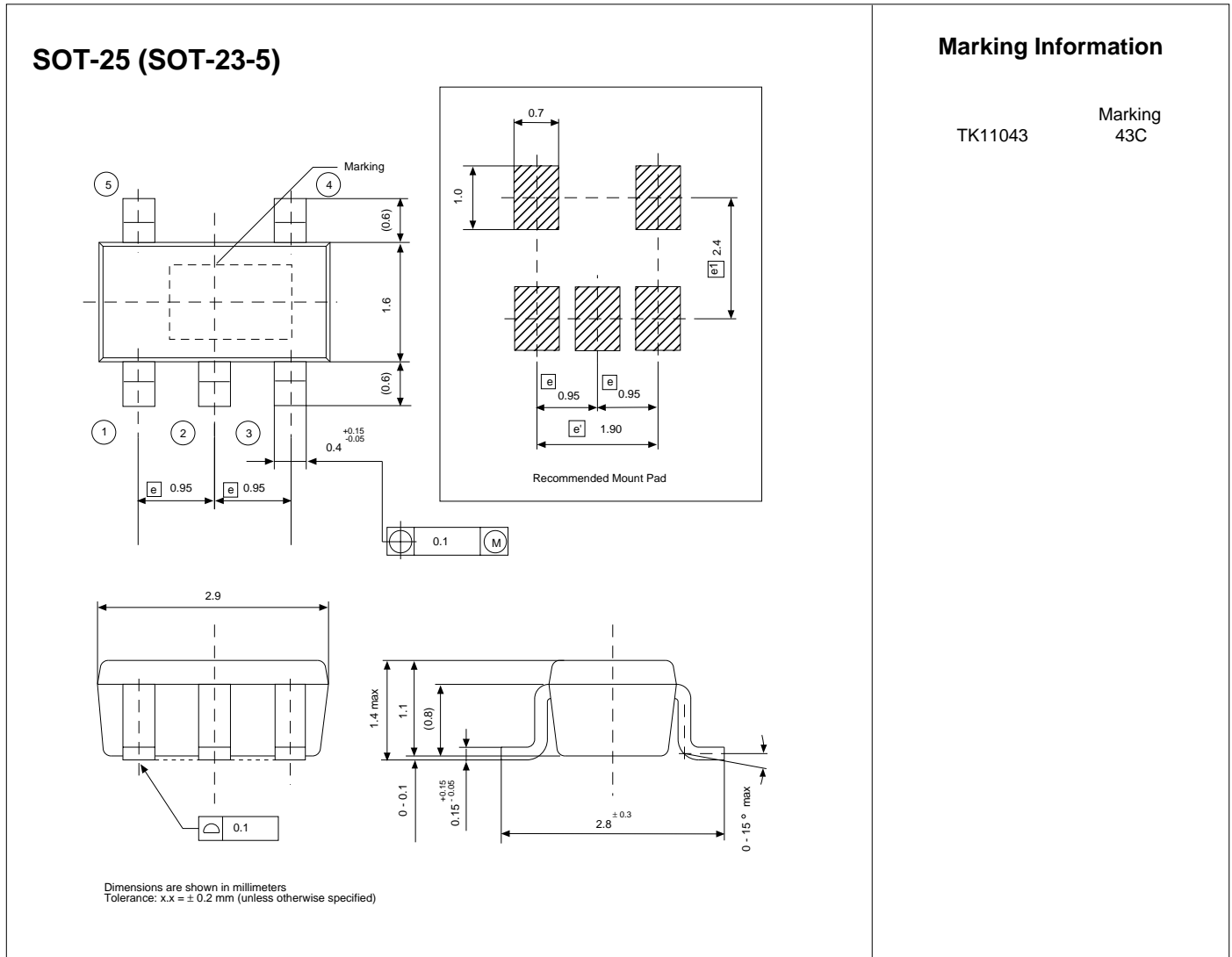

Toko America, Inc. Headquarters
1250 Feehanville Drive, Mount Prospect, Illinois 60056
Tel: (847) 297-0070 Fax: (847) 699-7864

TOKO AMERICA REGIONAL OFFICES

Midwest Regional Office
Toko America, Inc.
1250 Feehanville Drive
Mount Prospect, IL 60056
Tel: (847) 297-0070
Fax: (847) 699-7864

Western Regional Office
Toko America, Inc.
2480 North First Street, Suite 260
San Jose, CA 95131
Tel: (408) 432-8281
Fax: (408) 943-9790

Eastern Regional Office
Toko America, Inc.
107 Mill Plain Road
Danbury, CT 06811
Tel: (203) 748-6871
Fax: (203) 797-1223

Semiconductor Technical Support
Toko Design Center
4755 Forge Road
Colorado Springs, CO 80907
Tel: (719) 528-2200
Fax: (719) 528-2375

Visit our Internet site at <http://www.tokoam.com>

The information furnished by TOKO, Inc. is believed to be accurate and reliable. However, TOKO reserves the right to make changes or improvements in the design, specification or manufacture of its products without further notice. TOKO does not assume any liability arising from the application or use of any product or circuit described herein, nor for any infringements of patents or other rights of third parties which may result from the use of its products. No license is granted by implication or otherwise under any patent or patent rights of TOKO, Inc.