

SMALL EL LAMP DRIVER

FEATURES

- High Ratio of Brightness / Input Power
- Constant Brightness Versus Input Supply Changes
- Optimized for 3.5 nf to 12.5 nf Panel Capacitance
- Panel Voltage Slew Rates Controlled for Life Enhancement
- Panel Peak to Peak Voltage Independent of Input Voltage and Temperature
- Panel Peak to Peak Frequency Independent of Input Voltage and Temperature
- Miniature Package (SOT23L-6)
- Operates with Miniature Coil
- Minimum External Components
- Laser-Trimmed Fixed Frequency Operation
- PWM Control Method
- Adjustable Output Voltage
- Lower Noise (Audio and EMI)
- Split Power Supply Application

DESCRIPTION

The TK6591x Electroluminescent (EL) Lamp Driver has been optimized for battery controlled systems where power consumption and size are primary concerns. The miniature device size (SOT23L-6), together with the miniature Toko EL coils (D32FU, D31FU, D52FU), further helps system designers reduce the space required to drive the small EL panels.

The proprietary architecture (detailed in the Theory of Operation section) of the TK6591x provides a constant output power to the lamp, independent of variations in the battery voltage. This architecture allows the output voltage to remain relatively constant as battery voltages decay, without the need for directly sensing the high voltage output of the EL driver.

ORDERING INFORMATION

TK6591 MTL
 └───┬─── Lamp Frequency Code

LAMP FREQUENCY CODE		TAPE/REEL CODE	
TK65910	175 Hz	TK65915*	300 Hz
TK65911*	200 Hz	TK65916	325 Hz
TK65912	225 Hz	TK65917*	350 Hz
TK65913*	250 Hz	TK65918	375 Hz
TK65914	275 Hz	TK65919*	400 Hz

* Consult factory for availability of other frequencies.

APPLICATIONS

- Battery Powered Systems
- Cellular Telephones
- Pagers
- LCD Modules
- Wrist Watches
- Consumer Electronics

The oscillator circuits for the boost converter and lamp driver are both internally generated in the TK6591x, without the need for external components. The clock frequency of the boost converter is laser-trimmed to ensure good initial accuracy that is relatively insensitive to variations in temperature and supply voltage. The clock frequency of the lamp driver tracks the frequency of the boost converter by a constant scaling factor.

Furthermore, the drive architecture of the TK6591x has been designed to limit peak drive current delivered to the lamp. This approach limits the slew rate of the voltage across the lamp and has the potential to improve lamp life and decrease RF interference.

The TK6591x is available in a miniature, 6 pin SOT23L-6 surface mount package.

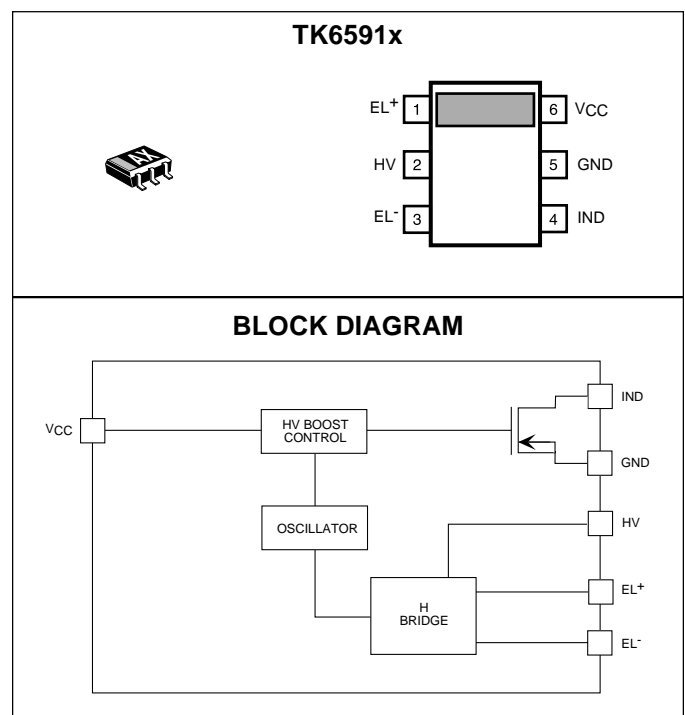

TK6591x

ABSOLUTE MAXIMUM RATINGS

V_{CC} Pin	6.5 V	Storage Temperature Range	-55 to +150 °C
All Pins Except V_{CC} and GND	V_{CLAMP}	Operating Temperature Range	-30 to +80 °C
Power Dissipation (Note 1)	600 mW	Junction Temperature	150 °C

TK6591x ELECTRICAL CHARACTERISTICS

$V_{CC} = 3.6$ V, $T_A = T_J = 25$ °C, unless otherwise specified.

SYMBOL	PARAMETER	TEST CONDITIONS	MIN	TYP	MAX	UNITS
V_{CC}	Input Supply Range		2.7	3.6	6	V
I_Q	Quiescent Current	Current into pin 6			200	μ A
I_{PEAK}	Peak Current Threshold		26	32	38	mA
F_{LAMP}	Lamp Frequency		See Table 1			Hz
F_{BOOST}	Boost Frequency		See Table 2			kHz
V_{CLAMP}	Boost Clamp Voltage	Force 100 μ A into HV pin	90	105	120	V
$D_{(MAX)}$	Maximum Duty Cycle		88	92	96	%
V_{OUT}	Peak to Peak Lamp Voltage	(Note 3)	125	140	155	V
I_{CONV}	Converter Supply Current	(Notes 2, 3)	See Table 3			mA

Note 1: Power dissipation is 600 mW when mounted as recommended (200 mW In Free Air). Derate at 4.8 mW/°C for operation above 25 °C.
 Note 2: Converter supply current is dependent upon the DC resistance of inductor L_1 . Lower DC resistances will result in lower supply currents.
 Note 3: When using test circuit below.
 Gen. Note: Refer to "INDUCTOR VALUE SELECTION" and "INDUCTOR TYPE SELECTION" of Design Considerations Section for choosing inductor.

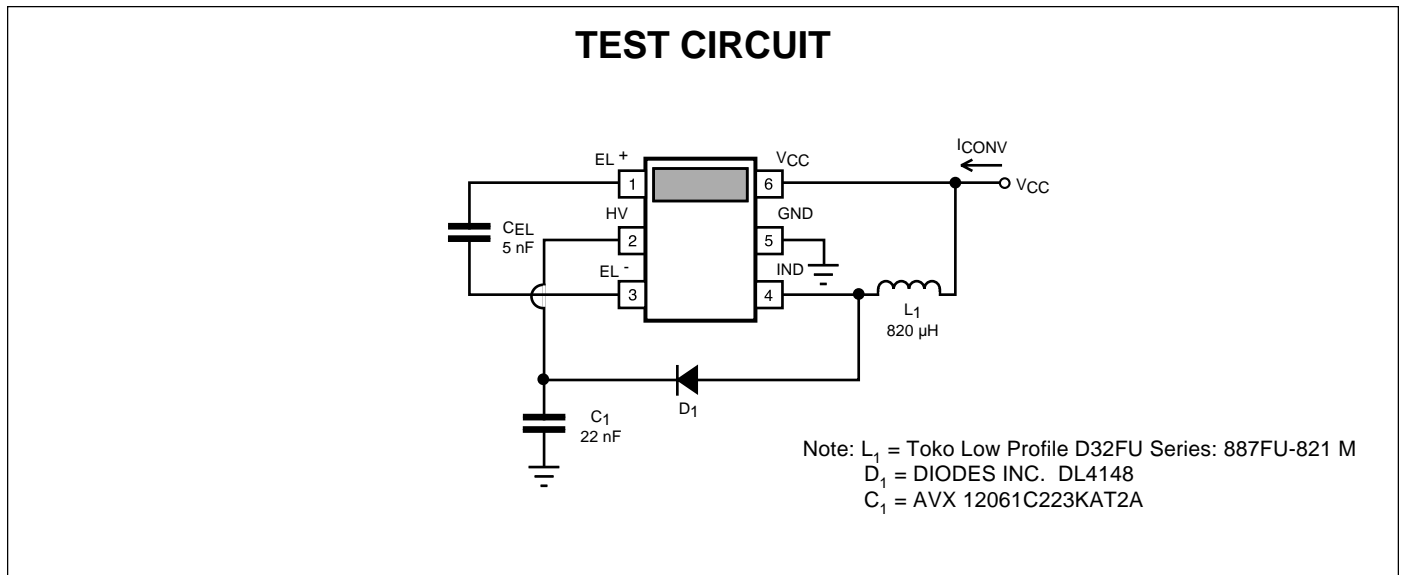

TK6591x ELECTRICAL CHARACTERISTICS

$V_{IN} = 3.6\text{ V}$, $T_A = T_j = 25\text{ }^\circ\text{C}$, unless otherwise specified.

TABLE 1: LAMP FREQUENCY

TOKO PART NO.	MIN.	TYP.	MAX.
TK65910	157 Hz	175 Hz	193 Hz
TK65911	180 Hz	200 Hz	220 Hz
TK65912	202 Hz	225 Hz	248 Hz
TK65913	225 Hz	250 Hz	275 Hz
TK65914	247 Hz	275 Hz	303 Hz
TK65915	270 Hz	300 Hz	330 Hz
TK65916	292 Hz	325 Hz	358 Hz
TK65917	315 Hz	350 Hz	385 Hz
TK65918	337 Hz	375 Hz	413 Hz
TK65919	360 Hz	400 Hz	440 Hz

TABLE 2: OSCILLATOR FREQUENCY

TOKO PART NO.	MIN.	TYP.	MAX.
TK65910	20.1 kHz	22.4 kHz	24.7 kHz
TK65911	23.0 kHz	25.6 kHz	28.2 kHz
TK65912	25.9 kHz	28.8 kHz	31.7 kHz
TK65913	28.8 kHz	32.0 kHz	35.2 kHz
TK65914	31.6 kHz	35.2 kHz	38.8 kHz
TK65915	34.5 kHz	38.4 kHz	42.3 kHz
TK65916	37.4 kHz	41.6 kHz	45.8 kHz
TK65917	40.3 kHz	44.8 kHz	49.3 kHz
TK65918	43.2 kHz	48.0 kHz	52.8 kHz
TK65919	46.1 kHz	51.2 kHz	56.3 kHz

TABLE 3: CONVERTER SUPPLY CURRENT

TOKO PART NO.	MIN.	TYP.	MAX.
TK65910	-	3.2 mA	6.4 mA
TK65911	-	3.6 mA	7.2 mA
TK65912	-	4.1 mA	8.2 mA
TK65913	-	4.5 mA	9.0 mA
TK65914	-	5.0 mA	10.0 mA
TK65915	-	5.4 mA	10.8 mA
TK65916	-	5.8 mA	11.6 mA
TK65917	-	6.3 mA	12.6 mA
TK65918	-	6.7 mA	13.4 mA
TK65919	-	7.2 mA	14.4 mA

**TYPICAL PERFORMANCE CHARACTERISTICS
USING TEST CIRCUIT**

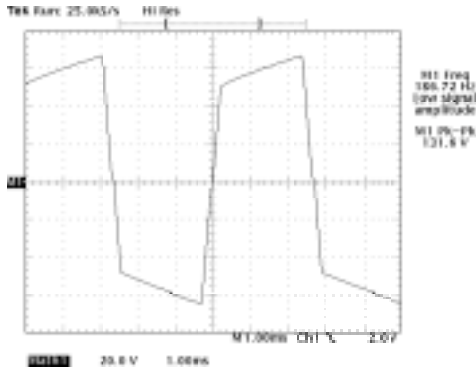

TK65911 Voltage Waveform Across 5 nF Lamp

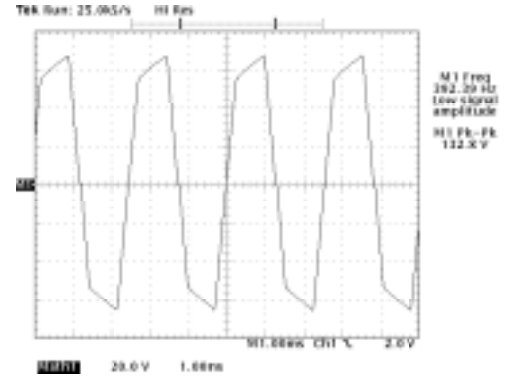

TK65919 Voltage Waveform Across 5 nF Lamp

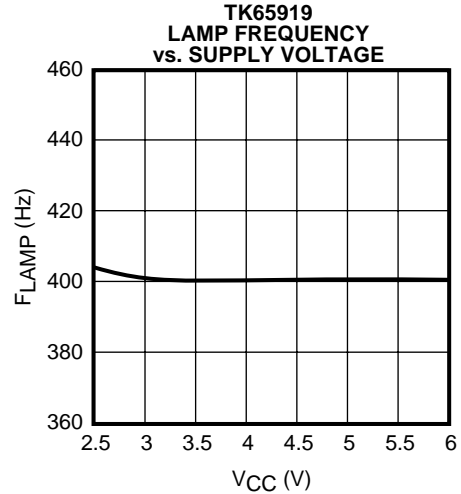
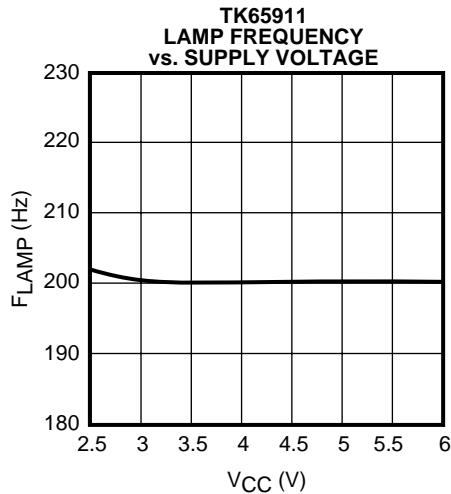
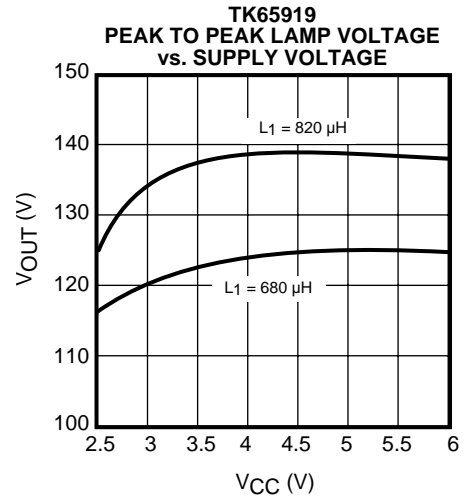
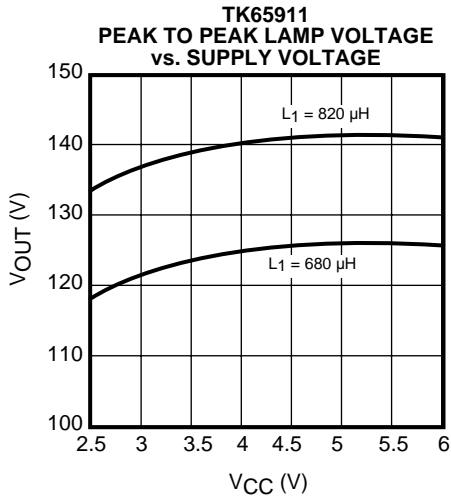

TYPICAL PERFORMANCE CHARACTERISTICS (CONT.) USING TEST CIRCUIT

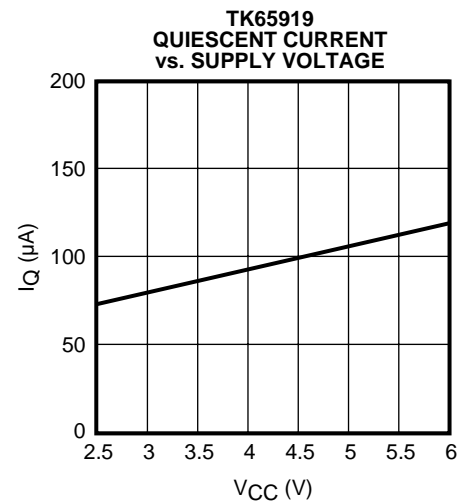
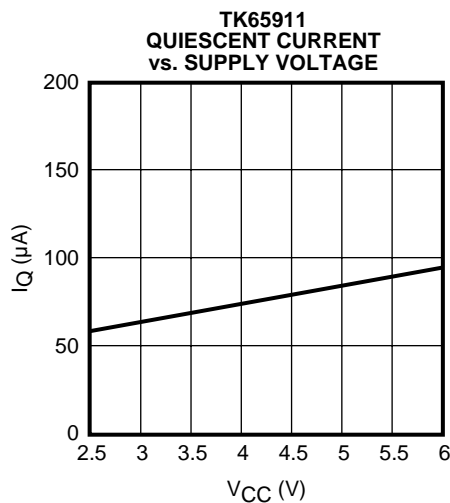
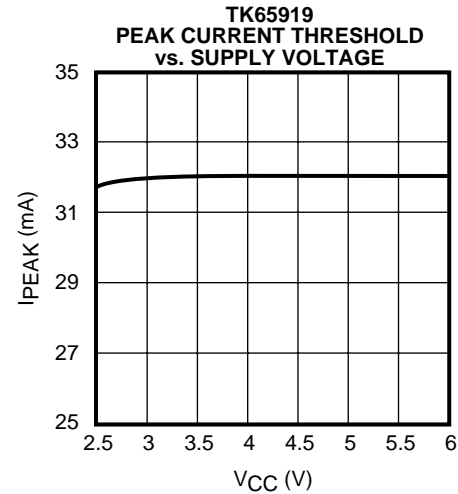
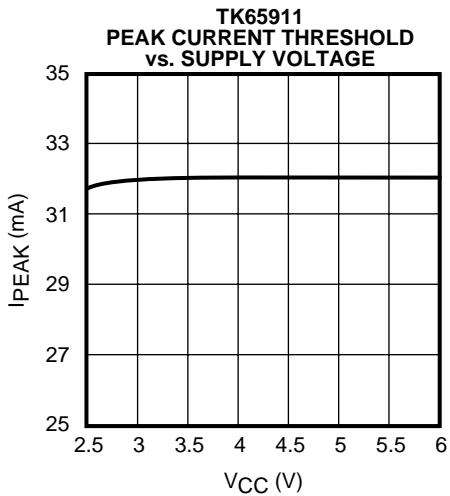
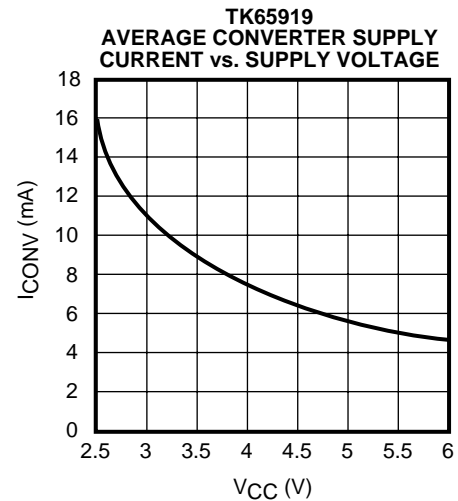
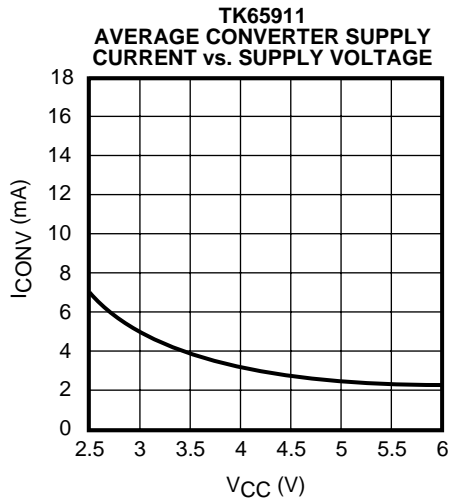

**TYPICAL PERFORMANCE CHARACTERISTICS (CONT.)
USING TEST CIRCUIT**

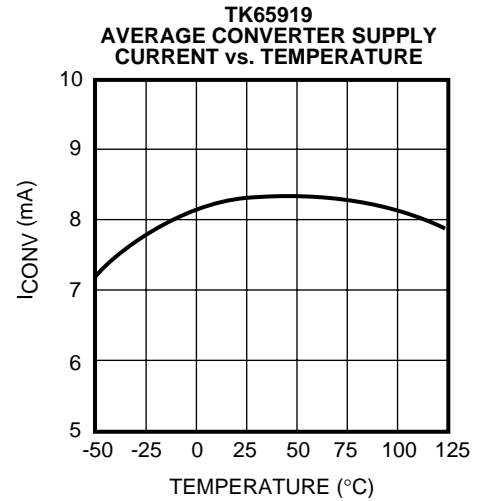
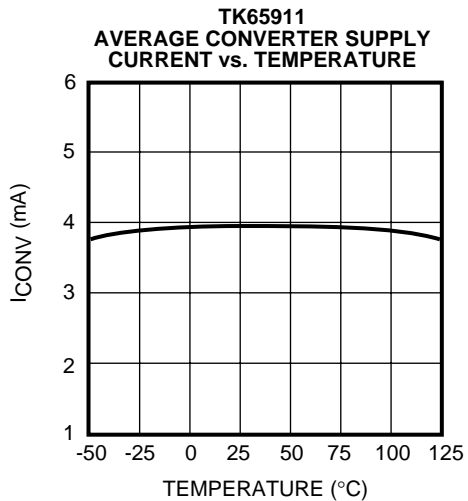
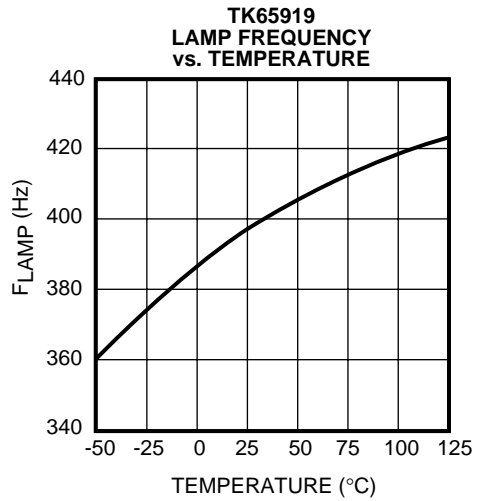
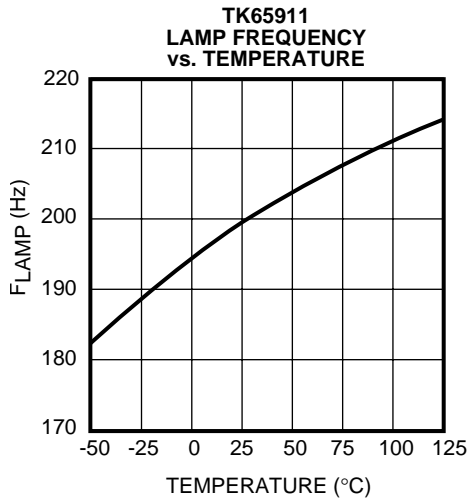
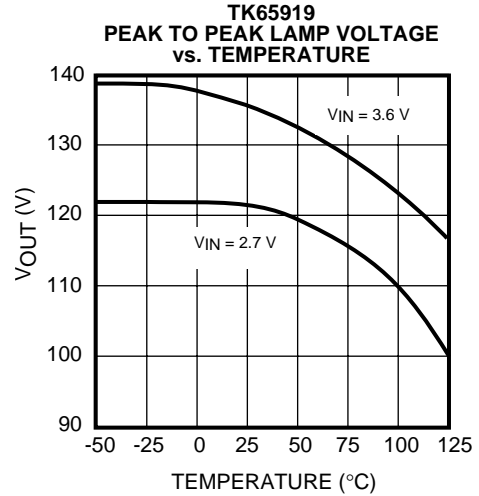
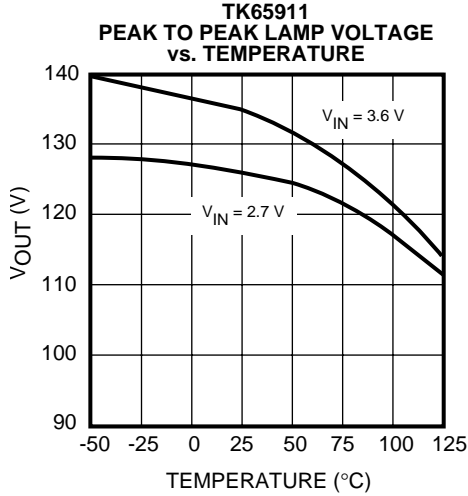

**TYPICAL PERFORMANCE CHARACTERISTICS (CONT.)
USING TEST CIRCUIT**

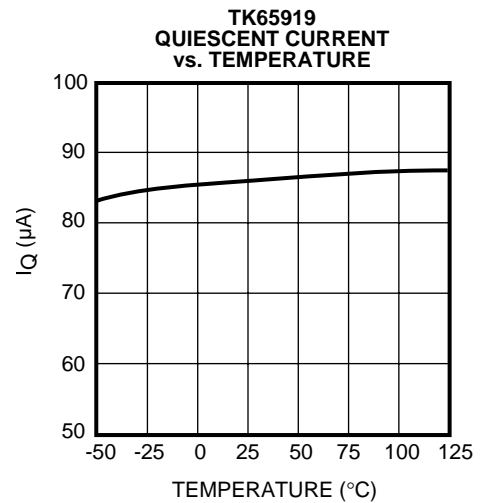
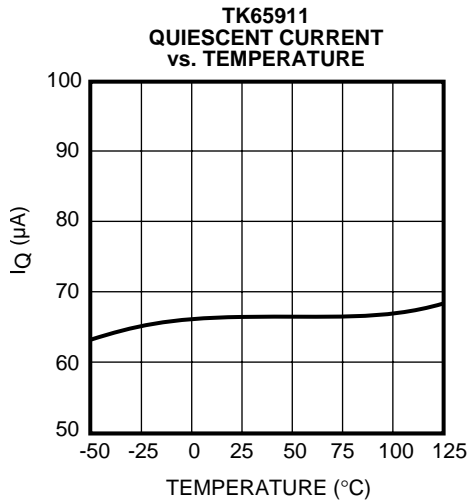
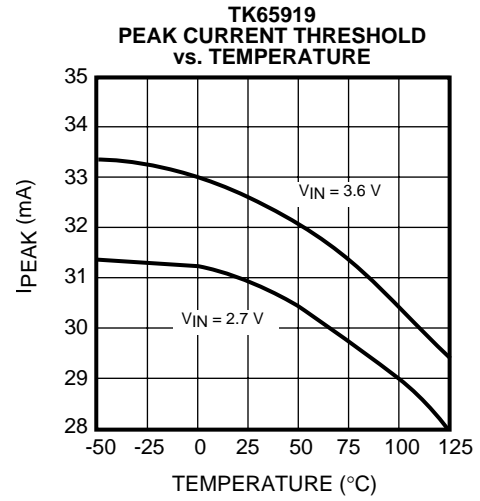
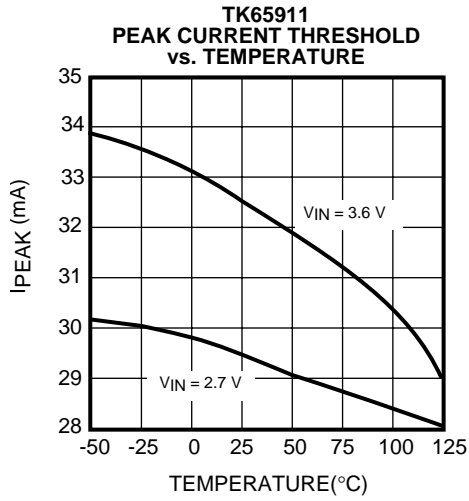

**TYPICAL PERFORMANCE CHARACTERISTICS (CONT.)
USING D_(MAX) TEST CIRCUIT**

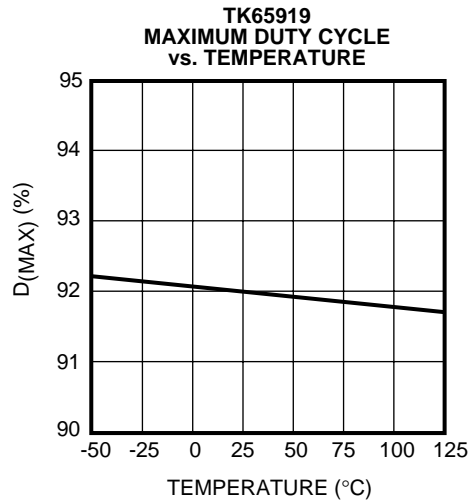
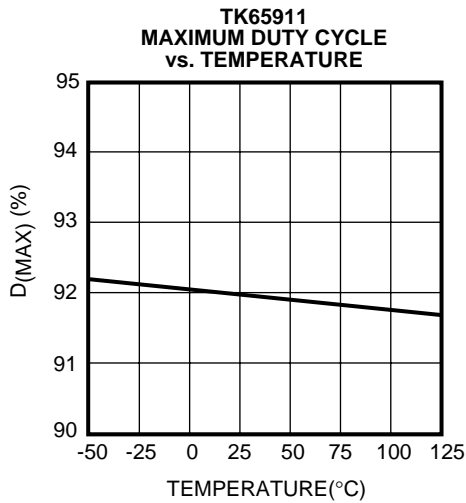
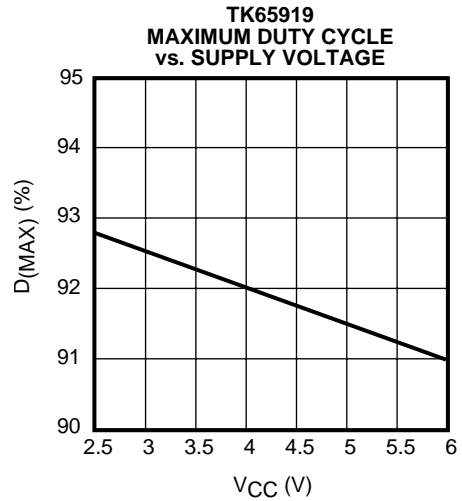
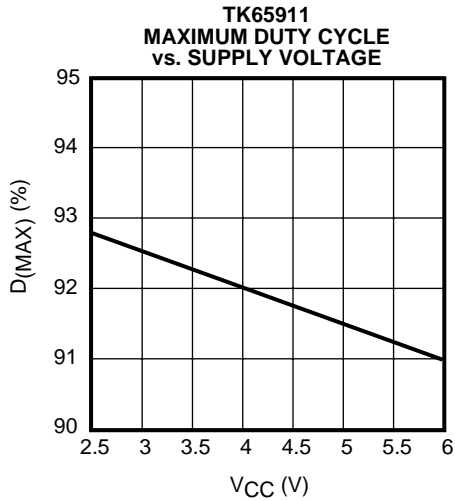

D_(MAX) TEST CIRCUIT

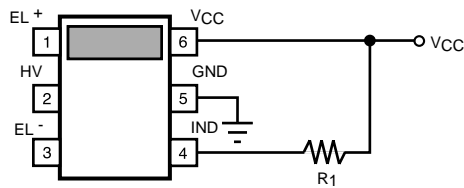

Note: R₁ = 470 Ω

THEORY OF OPERATION

An Electroluminescent (EL) Lamp is a strip of plastic, coated with a phosphorous material that emits light when a high voltage AC signal is applied to the terminals of the device. EL panels have the ability to light the entire panel uniformly. Because of this, they are gradually becoming more popular and widespread than LEDs. The amount of light emitted from an EL Lamp is typically proportional to the magnitude of the voltage applied to the lamp. Furthermore, the color of the light emitted by an EL Lamp is somewhat dependent upon the frequency of the applied drive signal. For most applications, a peak-to-peak voltage of 100 to 170 V, with a drive frequency of 175 to 400 Hz, provides optimal trade-off between lamp intensity and power consumption.

The capacitance of the EL Panel is typically proportional to the size of the lamp (a 1 square inch EL Panel typically exhibits approximately 5 nF of capacitance load). The TK6591x series of devices has been optimized to drive EL panels, which are approximately 1-2 square inches in size.

The Boost section of the TK6591x consists of a controller for stepping up a relatively low voltage (2.7 to 6 V) to a much higher voltage (50 to 90 V) needed to drive the EL Lamp. The boost section of the TK6591x uses a proprietary architecture which provides a relatively constant output power, independent of the input supply, without the need for sensing the high voltage output of the boost converter. By controlling the peak current through the switching element of the boost converter, the boost section provides a constant output power independent of the input supply.

The H-Bridge section of the TK6591x switches the high voltage output of the boost converter to the two terminals of the EL Lamp. By alternately switching the terminals of the lamp between the high voltage supply and ground, the peak-to-peak voltage developed across the lamp is effectively twice the high voltage generated by boost converter. Furthermore, the TK6591x limits the magnitude of the drive currents through the H-Bridge switches in order to minimize the edge rates developed across the EL Lamp. This approach protects the EL Panel from large current spikes and reduces the likelihood of high frequency noise components being injected into neighboring circuitry.

The Oscillator section of the TK6591x generates a fixed frequency clock source for the previously described Boost and H-Bridge sections, without the need for external components. The high frequency output of the oscillator is used for driving the boost controller. A lower frequency

clock is generated by dividing the high frequency clock by 128; this lower frequency clock corresponds to the drive frequency of the EL Lamp. The laser-trimmed oscillators are relatively insensitive to variations in temperature and supply voltage. Therefore, they provide good control of the lamp color emitted by the panel.

The circuit below illustrates a typical application where the TK6591x is driving a 1-square-inch EL Lamp with a capacitance of approximately 5 nF.

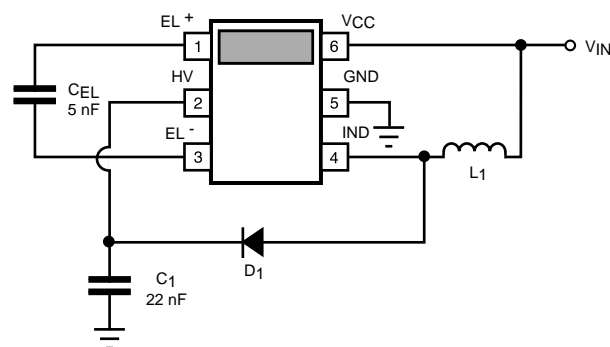

FIGURE 1: TYPICAL APPLICATION

By keeping the ratio of the boost frequency and the H-Bridge frequency constant, the peak-to-peak output voltage from the TK6591x becomes primarily dependent upon the capacitance of the EL Lamp, the peak current threshold of the boost converter, and the value of the inductive element used in the boost converter. For the TK6591x, the peak current threshold is laser-trimmed to 32 mA. The capacitive load of the EL Lamp is a function of panel size and is typically fixed. Therefore, the high voltage output of the boost converter can be set to a desired voltage by selecting the appropriate value of the inductive element used in the boost converter.

$$I_{PEAK} = \text{Boost Peak Current Threshold (32 mA)}$$

$$C_{EL} = \text{Capacitance of EL Lamp}$$

$$L = \text{Inductance Value}$$

$$V_{HV} = (I_{PEAK} / 2) \times \sqrt{(L / C_{EL}) \times 128}$$

THEORY OF OPERATION (CONT.)

With properly selected components, the TK6591x will nominally support peak output voltages to 90 V (180 V_{PK-PK}). Should the EL Panel become disconnected from the driver outputs, the removal of the load can cause the output voltage to increase beyond 90 V. To protect against this fault condition, a clamp circuit exists on the high voltage output which nominally limits the output voltage to a typical value of 105 V (210 V_{PK-PK}).

DETAILS CONCERNING THE H-BRIDGE SECTION OPERATION

In an effort to extend EL lamp life, reduce EMI emissions, and reduce the power draw of the IC, current sources to control the charging and discharging of the EL lamp panel and special sequencing control of the H-bridge FETs were added to the H-bridge of TK659xx.

Current sources were added between ground and the sources of the low-side N-channel FETs (Figure 2). Therefore, the current into and out of the EL panel is controlled and limited.

The FETs are turned off and on in the sequence shown in Figure 3. As is noted in Figure 3, there is a period of time when both of lower N-channel FETs are turned on and both of upper P-channel FETs are turned off. **This provides a period of time to discharge the EL panel capacitance completely;** before starting to recharge it again with current from HV voltage rail. Therefore, this special sequencing method prevents taking current off the HV voltage rail during the discharge of EL panel capacitance and operates more efficiently.

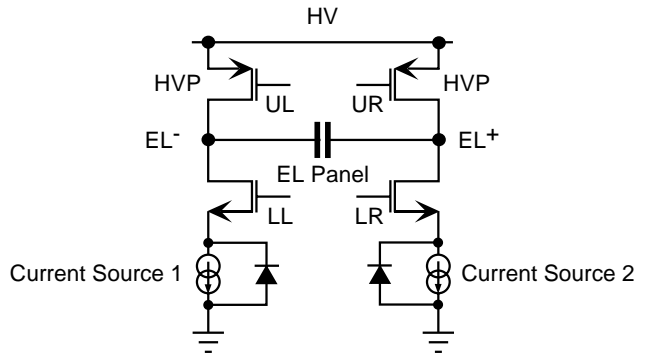

FIGURE 2: H-BRIDGE SCHEMATIC

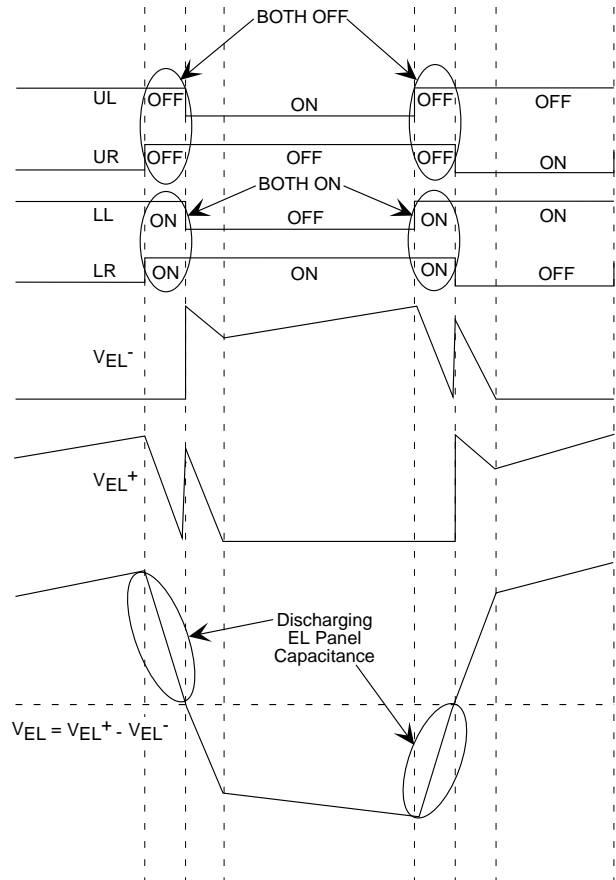

FIGURE 3: H-BRIDGE SEQUENCING WAVEFORMS

PIN DESCRIPTIONS

SUPPLY PIN (V_{CC})

This pin is the positive input supply for the TK6591x. Good design practices dictate capacitive decoupling to the ground pin.

GROUND PIN (GND)

The pin provides the ground connection for the IC.

IND PIN

This pin is periodically pulled to ground by a power transistor acting as an internal switch to the TK6591x. Externally, this pin is typically connected to an inductor and a rectifying diode. By modulating the switching action of the internal switch, the TK6591x can boost the relatively low voltage of the battery to the high voltage required to drive the EL Lamp.

HV PIN

This pin is connected to the filter capacitor and the cathode of the rectifying diode in order to generate a high voltage supply. This high voltage supply is switched to the terminals of the EL Lamp through the H-Bridge.

EL⁺ PIN

This pin is connected to one side of the EL Panel.

EL⁻ PIN

This pin is connected to the other side of the EL Panel.

Note: Measuring the voltage across the EL lamp (EL⁺ pin to EL⁻ pin) should be done with balanced scope probes using differential measurement techniques to obtain a true waveform of the voltage across the EL lamp.

DESIGN CONSIDERATIONS

INDUCTOR VALUE SELECTION

Designing an EL Driver utilizing the TK6591x is a very simple task. The primary component affecting the behavior of the converter is the inductor. Essentially, the entire design task primarily consists of selecting the proper inductor value and type given the operating conditions of the EL Panel (e.g., lamp capacitance, frequency, output voltage, supply range). The following tables and charts are intended to simplify the selection of the inductor.

Given the capacitance of the EL Lamp, and the peak output voltage requirements, the following table can be utilized to select the value of the inductive component.

TABLE 4: PEAK OUTPUT VOLTAGE VS. INDUCTOR VALUE AND LAMP CAPACITANCE

INDUCTOR VALUE	3.5 nF LAMP	5.0 nF LAMP	6.5 nF LAMP	8.0 nF LAMP	9.5 nF LAMP	11.0 nF LAMP	12.5 nF LAMP
220 μ H	45 V	38 V	33 V	30 V	28 V	26 V	24 V
270 μ H	50 V	42 V	37 V	33 V	30 V	28 V	26 V
330 μ H	52 V	44 V	38 V	34 V	32 V	29 V	28 V
390 μ H	57 V	47 V	42 V	37 V	34 V	32 V	30 V
470 μ H	62 V	52 V	46 V	41 V	38 V	35 V	33 V
560 μ H	68 V	57 V	50 V	45 V	41 V	38 V	36 V
680 μ H	75 V	63 V	55 V	49 V	45 V	42 V	40 V
820 μ H	82 V	69 V	60 V	54 V	50 V	46 V	43 V
1000 μ H	Close to 100 V operation check capacitor C ₁ voltage rating	76 V	67 V	60 V	55 V	51 V	48 V
1200 μ H		83 V	73 V	66 V	60 V	56 V	53 V
1500 μ H		82 V	73 V	67 V	63 V	59 V	
1800 μ H		89 V	80 V	74 V	69 V	64 V	
2200 μ H		89 V	82 V	76 V	71 V		
2700 μ H		90 V	84 V	79 V			
3300 μ H		87 V					

Note: The voltages indicated in the table above may not be achievable under certain circumstances (i.e., low battery or higher drive frequencies). Refer to the charts on page 12 to determine which output voltage/coil combination can be supported by the EL driver.

As an example as to how the above table is to be used, assume that we have a 1-square-inch panel (5 nF capacitance) and we would like the peak-to-peak voltage across the lamp to be 140 V. The peak voltage on either terminal would be 70 V (140 V / 2). Referring to the table above, we can see that using a 820 μ H coil the peak voltage developed across a 5 nF Lamp would be approximately 69 V. In this particular example, the inductive component should have a value of 820 μ H.

INDUCTOR TYPE SELECTION

After the value of the inductor has been selected, an appropriate coil type needs to be selected taking into account such factors as DC resistance and current capability. The following charts can be utilized for selecting the proper family of Toko Coils. Furthermore, the following charts will also indicate if the TK6591x is the appropriate driver given the frequency and input supply requirements. If the TK6591x does not have sufficient drive capability given the input supply and frequency

DESIGN CONSIDERATIONS (CONT.)

requirements, the following charts will suggest the TK6592x family of EL Drivers which have higher drive capabilities. To utilize the following charts in selecting an appropriate coil, perform the following steps:

- 1) From the following charts, select the chart that matches the part number of the Toko EL Driver that will be used in the application. The part number of the Toko EL Driver will be dependant upon the desired frequency of the EL panel (e.g., TK65911 = 200Hz).
- 2) Determine input supply voltage range (e.g., 4 to 6 V). The x-axis of the following charts represent the minimum expected supply voltage. Below this minimum supply voltage the EL Driver output may begin to droop. On the appropriate chart, draw a vertical line upward from the minimum supply voltage represented on the x-axis (e.g., 4V).
- 3) Draw a horizontal line passing through the chosen inductor value on the y-axis (e.g., 820 μH).
- 4) The vertical and horizontal lines drawn in steps 2 and 3 respectively will intersect at a point. This point will lie in one of four regions of the chart (e.g., D31FU). These four regions suggest which family of Toko Coils to use.

Of the three coil families suggested in these charts, the D31FU has the smallest physical size but also has higher DC resistance. The D52FU series of coils has the largest physical size and the lowest DC resistance. The D52FU or the D32FU can be used as a reasonable substitute for the D31FU. Similarly, the D52FU can be used as a replacement for the D32FU. Substituting a coil with lower DC resistance will generally result in a system that will consume less power supply current.

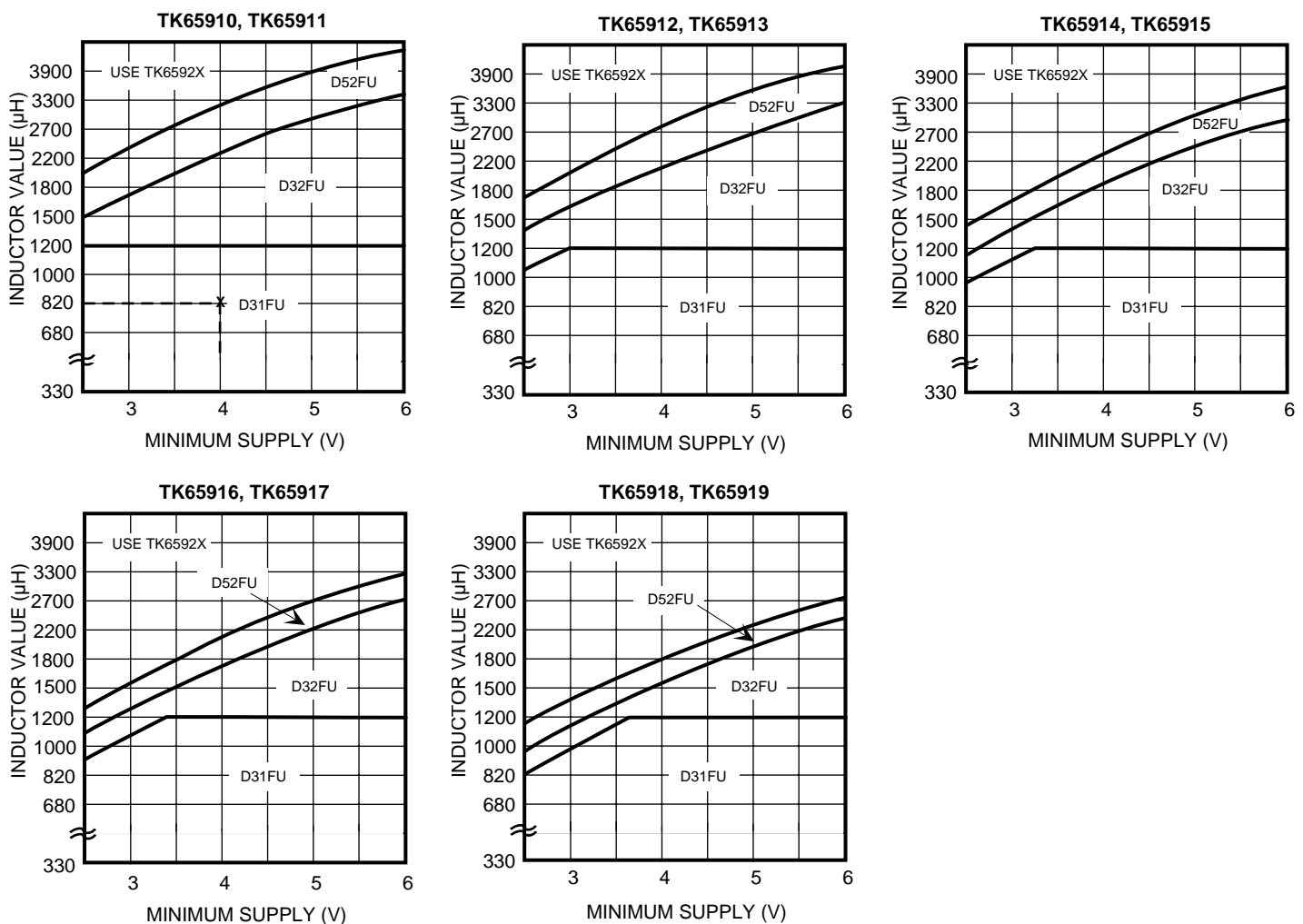

APPLICATION INFORMATION

LOW VOLTAGE SPLIT SUPPLY APPLICATION

The split power supply application of this EL driver IC is a circuit configuration (see Figure 4) in which the V_{CC} IC power ($V_{control}$) is separated or split away from the main power input (V_{power}) supplying current to the inductor.

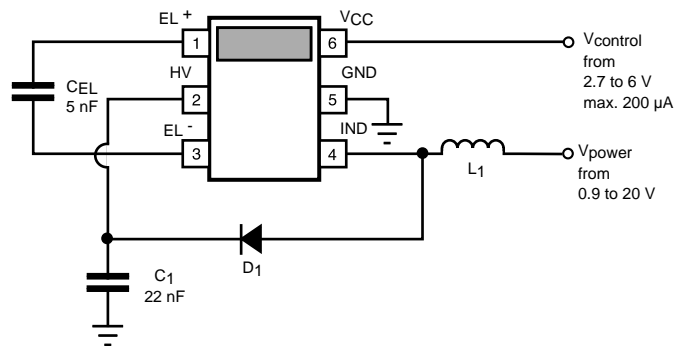

FIGURE 4: SPLIT SUPPLY APPLICATION CIRCUIT

The voltage supplied to the V_{CC} pin of the IC ($V_{control}$) needs to be maintained in the 2.7 V to 6.0 V range, but the current draw on this power supply rail of the system would be very small (under 200 μ A). This $V_{control}$ can be used to turn on and off the EL lamp driver, which permits the V_{power} to be connected to the battery or other power source **directly** with the **least amount of resistance in the power path as possible**.

Now with the V_{CC} power for the IC ($V_{control}$) being supplied from a different source, the main power (V_{power}) can be any voltage between 0.9 V and 20 V. But it is **critical to properly select the inductor** such that the proper peak current regulation is maintained over the input voltage operating range of the converter.

If the inductor value is too large the current will rise too slowly and not have time to reach its set peak current trip point at low input voltages, but at high input voltage the current might rise too quickly and overshoot the set peak current trip point.

The primary low voltage battery applications for this part are in a single cell or a dual cell alkaline system (such as a pager or PDA). These systems are assumed to have a minimum useable input voltage of 0.9 V for the single cell system and 1.8 V for the dual cell system.

For low converter input voltages (0.9 V and 1.8 V minimum input voltages), the following Table 5 shows the recommended maximum inductance value for a given device part number (therefore a given frequency of operation) and a minimum input voltage. Each cell in the table gives three inductance values; each value (in μ H) corresponds to each type of specialized Toko EL driver inductors (D31FU, D32FU, and D52FU types of Toko inductors).

APPLICATION INFORMATION (CONT.)

TABLE 5: INDUCTANCE SELECTION TABLE FOR SINGLE AND DUAL CELL ALKALINE SYSTEMS

PART NO.	TK65910	TK65911	TK65912	TK65913	TK65914	TK65915	TK65916	TK65917	TK65918	TK65919
f lamp	175 Hz	200 Hz	225 Hz	250 Hz	275 Hz	300 Hz	325 Hz	350 Hz	375 Hz	400 Hz
f converter	22.4 kHz	25.6 kHz	28.8 kHz	32.0 kHz	35.2 kHz	38.4 kHz	41.6 kHz	44.8 kHz	48.0 kHz	51.2 kHz
min.Vp L type										
0.9V D31FU	330 μ H	270 μ H	270 μ H	270 μ H	270 μ H	220 μ H	220 μ H	220 μ H	220 μ H	220 μ H
D32FU	390 μ H	390 μ H	390 μ H	330 μ H	330 μ H	330 μ H	330 μ H	---	---	---
D52FU	560 μ H	470 μ H	470 μ H	390 μ H	390 μ H	390 μ H	330 μ H	330 μ H	330 μ H	330 μ H
1.8V D31FU	680 μ H	680 μ H	680 μ H	680 μ H	680 μ H	560 μ H	560 μ H	560 μ H	560 μ H	470 μ H
D32FU	1000 μ H	820 μ H	820 μ H	820 μ H	680 μ H	680 μ H	680 μ H	680 μ H	680 μ H	560 μ H
D52FU	1200 μ H	1200 μ H	1000 μ H	1000 μ H	820 μ H	820 μ H	820 μ H	820 μ H	680 μ H	680 μ H

After selecting the inductor type and value, Table 4 of the TK6591X data sheet can be used to determine the typical output voltage for a given loading of EL lamp capacitance. If you wish to reduce this output voltage, just reduce the inductor's inductance value.

The TK6591X is the recommended part type to use in the low voltage single cell (0.9 V input) split supply application because it has the lowest peak current set point of the TK659XX family of EL drivers. This, therefore, restricts the size of EL panels that can be driven to those with smaller capacitance values.

NOISE CONSIDERATIONS

There are two specific noise types relevant to the user when it comes to choosing EL Drivers: the Audio Noise and the Electromagnetic Interference(EMI) Noise.

The EMI Noise would most likely come from the boost converter/coil section. The Toko EL Driver has specifically been designed to address this issue.

The device runs at a fixed frequency and the frequency is controlled tightly in order to avoid interference.

Furthermore, the panel frequency is forced to be a 128 submultiple of the boost frequency avoiding any type of beating frequencies.

By choosing shielded coils, the EMI noise problem can further be reduced.

The Audio Noise can come from several components which make up the system.

The coil, if operated in the audio range would be a source of noise. The Toko EL Driver was carefully designed to give the user the choice of 10 frequencies such that the coil frequency will always be above audio range. Since the device operates at a fixed frequency in discontinuous conduction mode, there are no possible submultiples which would cause audible noise.

The filter capacitor can be a source of audio noise. Furthermore, depending on how this cap is mounted, the mounting can act as an amplifier (as a speaker box). Certain ceramic caps driven from a high voltage source as in the EL Driver case, demonstrate a PIEZOELECTRIC effect which is distinguishable in the Audio Range.

Other types of caps, such as film type do not denote an audio noise.

The panel itself, being operated well into the Audio Range (175 Hz to 400 Hz) and of a capacitive nature driven from high voltage may also display Audible Noise. Mounting of this panel can enhance or diminish this natural effect of the panel.

LAYOUT

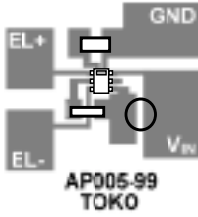
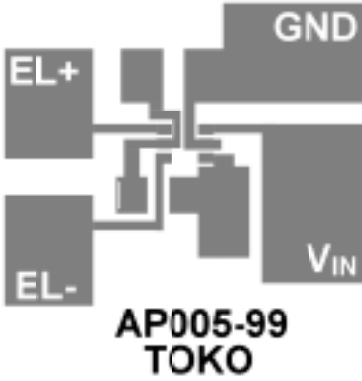

Actual Size

2x

SPLIT SUPPLY LAYOUT

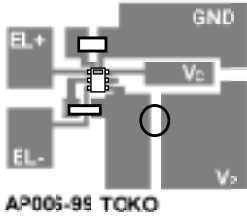
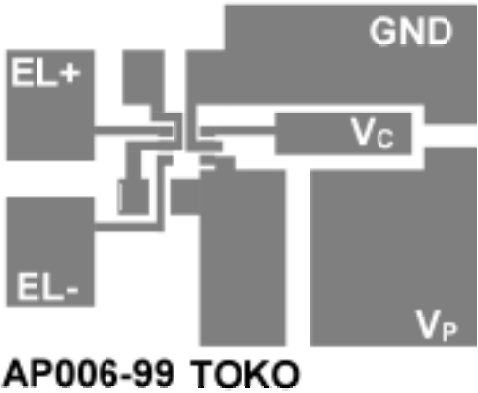

Actual Size

2x

NOTES

NOTES

NOTES

PACKAGE OUTLINE

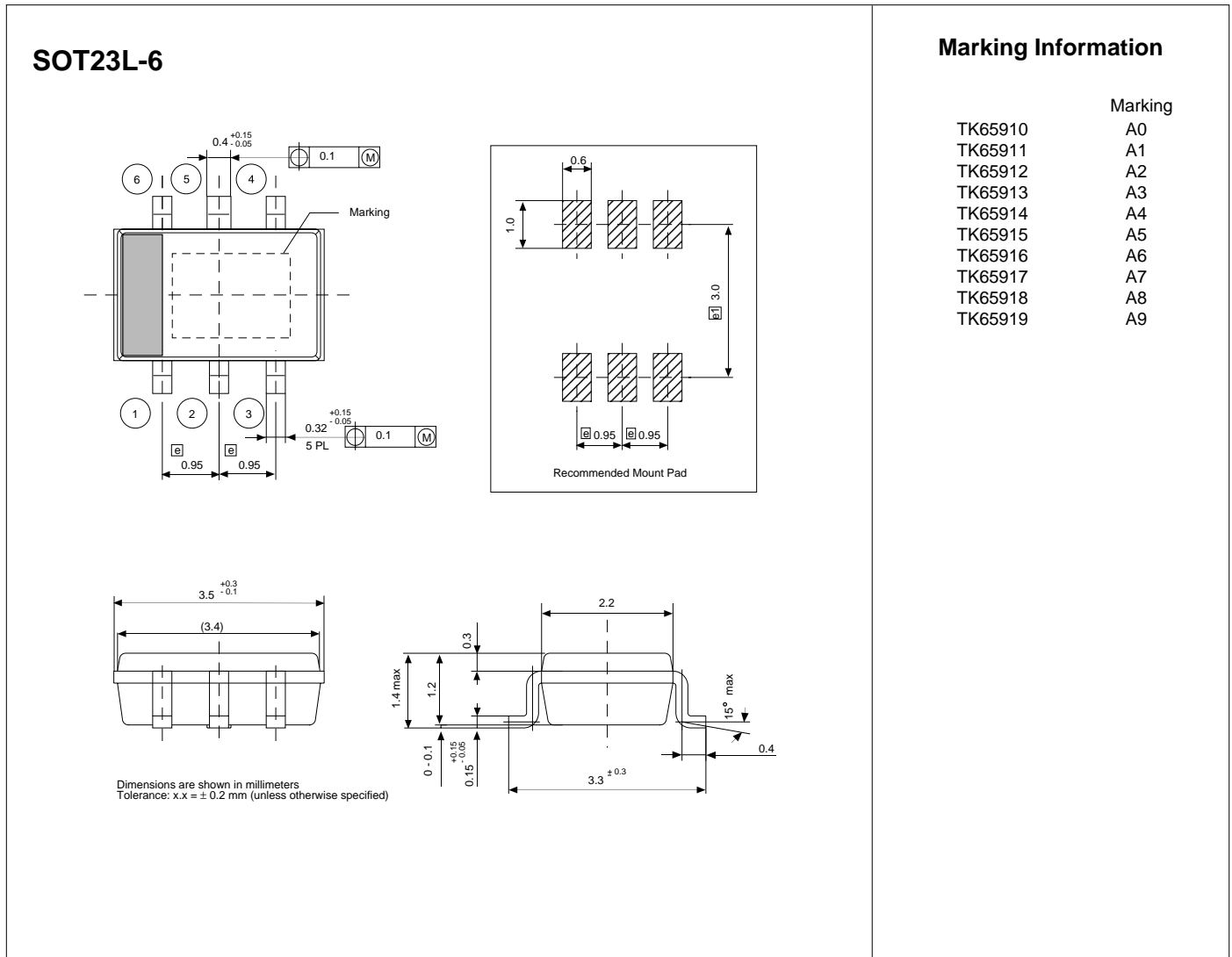

Toko America, Inc. Headquarters
 1250 Feehanville Drive, Mount Prospect, Illinois 60056
 Tel: (847) 297-0070 Fax: (847) 699-7864

TOKO AMERICA REGIONAL OFFICES

Midwest Regional Office
 Toko America, Inc.
 1250 Feehanville Drive
 Mount Prospect, IL 60056
 Tel: (847) 297-0070
 Fax: (847) 699-7864

Western Regional Office
 Toko America, Inc.
 2480 North First Street, Suite 260
 San Jose, CA 95131
 Tel: (408) 432-8281
 Fax: (408) 943-9790

Eastern Regional Office
 Toko America, Inc.
 107 Mill Plain Road
 Danbury, CT 06811
 Tel: (203) 748-6871
 Fax: (203) 797-1223

Semiconductor Technical Support
 Toko Design Center
 4755 Forge Road
 Colorado Springs, CO 80907
 Tel: (719) 528-2200
 Fax: (719) 528-2375

Visit our Internet site at <http://www.tokoam.com>

The information furnished by TOKO, Inc. is believed to be accurate and reliable. However, TOKO reserves the right to make changes or improvements in the design, specification or manufacture of its products without further notice. TOKO does not assume any liability arising from the application or use of any product or circuit described herein, nor for any infringements of patents or other rights of third parties which may result from the use of its products. No license is granted by implication or otherwise under any patent or patent rights of TOKO, Inc.