

TOSHIBA Photocoupler Photo Relay

## TLP227GA, TLP227GA-2

Modem  
Telecommunications  
PBXs

The Toshiba TLP227GA series consist of a gallium arsenide infrared-emitting diode optically coupled to a photo-MOSFET in a 4-pin DIP or a 8-pin DIP package, and has a peak off-State voltage of 400 V.

- Normally off function
- TLP227GA : DIP4 (1 form A)  
TLP227GA-2 : DIP8 (2 form A)
- Peak off-state voltage : 400 V (min)
- Trigger LED current : 3 mA (max)
- On-state current : 120 mA (max)
- On-state resistance : 35Ω (max)
- Isolation voltage : 2500 Vrms (min)

### Pin Configuration (top view)

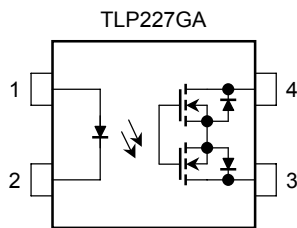

1: Anode  
2: Cathode  
3: Drain  
4: Drain

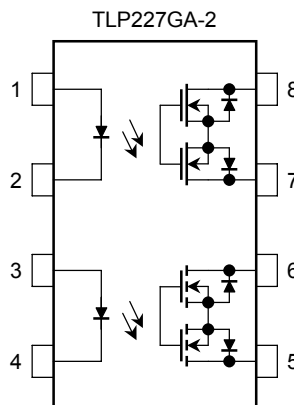

1, 3: Anode  
2, 4: Cathode  
5 : Drain D1  
6 : Drain D2  
7 : Drain D3  
8 : Drain D4

Unit: mm

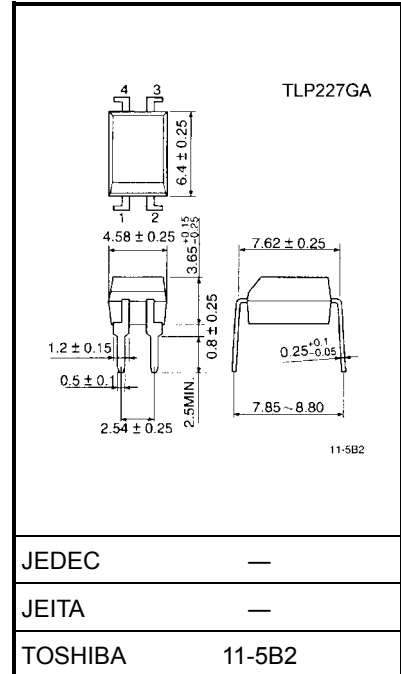

Weight: 0.26 g (typ.)

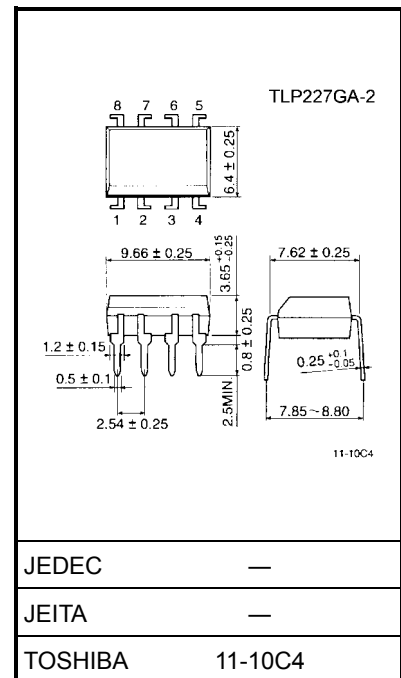

Weight: 0.54 g (typ.)

## Maximum Rating (Ta = 25°C)

Characteristic		Symbol	Rating	Unit	
Led	Forward current	$I_F$	50	mA	
	Forward current derating (Ta ≥ 25°C)	$\Delta I_F/^\circ\text{C}$	-0.5	mA/°C	
	Peak forward current (100 μs pulse, 100 pps)	$I_{FP}$	1	A	
	Reverse voltage	$V_R$	5	V	
	Junction temperature	$T_j$	125	°C	
Detector	Off-state output terminal voltage		$V_{OFF}$	400	V
	On-state current	TLP227GA	$I_{ON}$	120	Ma
		TLP227GA-2			
	On-state current rating (Ta ≥ 25°C)	TLP227GA	$\Delta I_{ON}/^\circ\text{C}$	-1.2	mA/°C
		TLP227GA-2			
	Junction temperature		$T_j$	125	°C
	Storage temperature range		$T_{stg}$	-55~125	°C
Operating temperature range		$T_{opr}$	-40~85	°C	
Lead soldering temperature (10 s)		$T_{sol}$	260	°C	
Isolation voltage (AC, 1 min., R.H. ≤ 60%) (Note 1)		$BV_S$	2500	Vrms	

Note 1: LED pins are shorted together. Detector pins are also shorted together.

## Recommended Operating Conditions

Characteristic	Symbol	Min	Typ.	Max	Unit
Supply voltage	$V_{DD}$	—	—	320	V
Forward current	$I_F$	5	7.5	25	mA
On-state current	$I_{ON}$	—	—	100	mA
Operating temperature	$T_{opr}$	-20	—	65	°C

## Individual Electrical Characteristics (Ta = 25°C)

Characteristic		Symbol	Test Condition	Min	Typ.	Max	Unit
Led	Forward voltage	$V_F$	$I_F = 10 \text{ mA}$	1.0	1.15	1.3	V
	Reverse current	$I_R$	$V_R = 5 \text{ V}$	—	—	10	μA
	Capacitance	$C_T$	$V = 0, f = 1 \text{ MHz}$	—	30	—	pF
Detector	Off-state current	$I_{OFF}$	$V_{OFF} = 400 \text{ V}$	—	—	1	μA
	Capacitance	$C_{OFF}$	$V = 0, f = 1 \text{ MHz}$	—	—	—	pF

## Coupled Electrical Characteristics (Ta = 25°C)

Characteristic	Symbol	Test Condition	Min	Typ.	Max	Unit
Trigger LED current	$I_{FT}$	$I_{ON} = 120 \text{ mA}$	—	1	3	mA
On-state resistance	$R_{ON}$	$I_{ON} = 120 \text{ mA}, I_F = 5 \text{ mA}$	—	18	35	$\Omega$

## Isolation Characteristics (Ta = 25°C)

Characteristic	Symbol	Test Condition	Min	Typ.	Max	Unit
Capacitance input to output	$C_S$	$V_S = 0 \text{ V}, f = 1 \text{ MHz}$	—	0.8	—	pF
Isolation resistance	$R_S$	$V_S = 500 \text{ V}, R.H. \leq 60\%$	$5 \times 10^{10}$	$10^{14}$	—	$\Omega$
Isolation voltage	$BV_S$	AC, 1 min	2500	—	—	Vrms
		AC, 1 s (in oil)	—	5000	—	Vrms
		DC, 1 min (in oil)	—	5000	—	Vdc

## Switching Characteristics (Ta = 25°C)

Characteristic	Symbol	Test Condition	Min	Typ.	Max	Unit
Turn-on time	$t_{ON}$	$R_L = 200 \Omega$ $V_{DD} = 20 \text{ V}, I_F = 5 \text{ mA}$ (Note 2)	—	—	1	ms
Turn-off time	$t_{OFF}$		—	—	1	

Note 2: Switching time test circuit

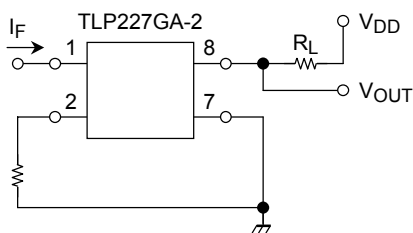
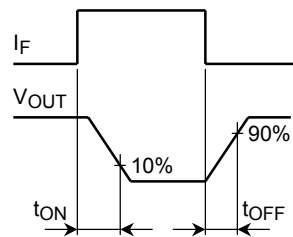
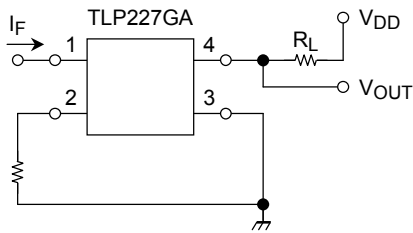

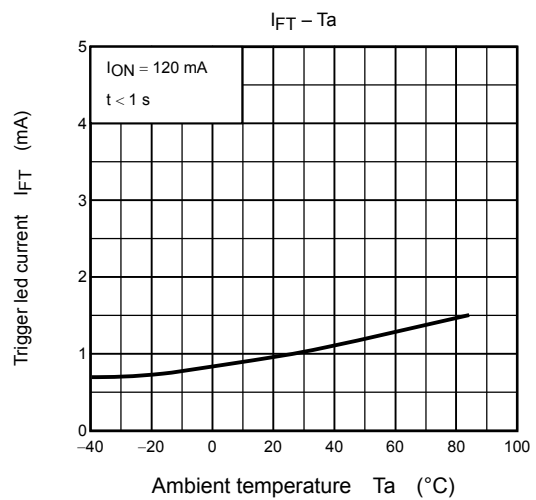
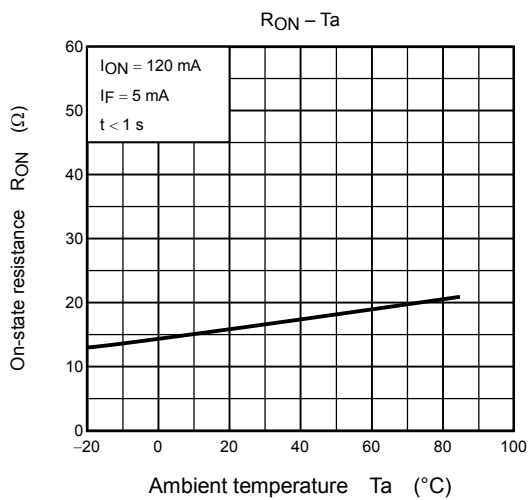
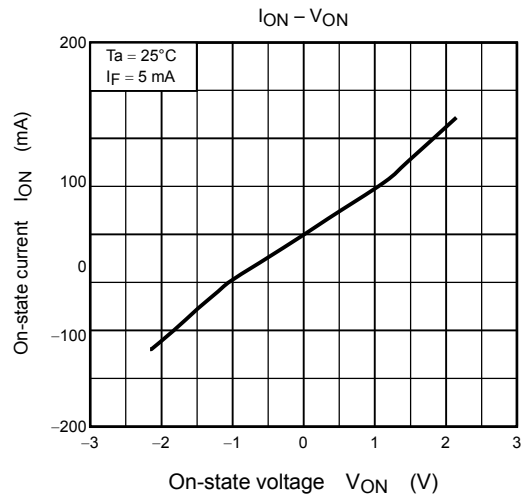
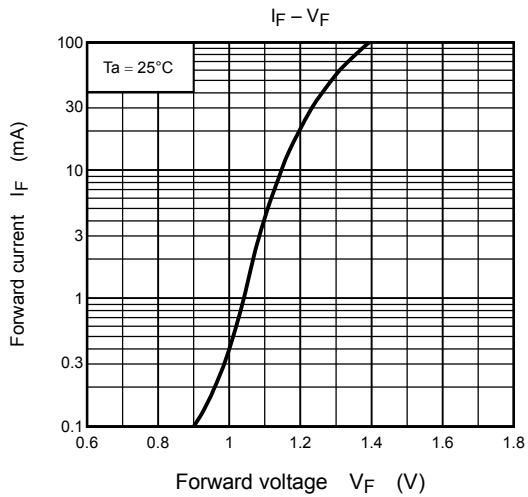
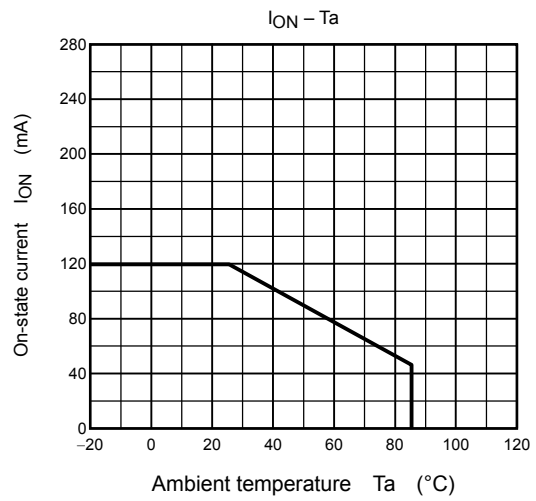
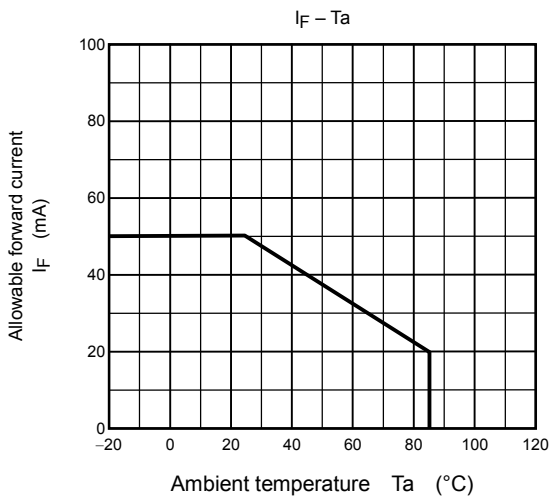

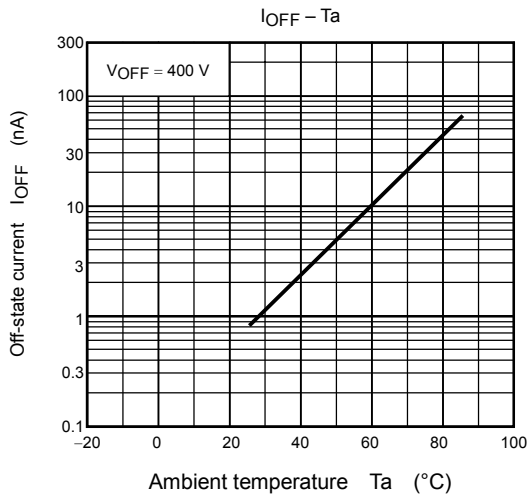
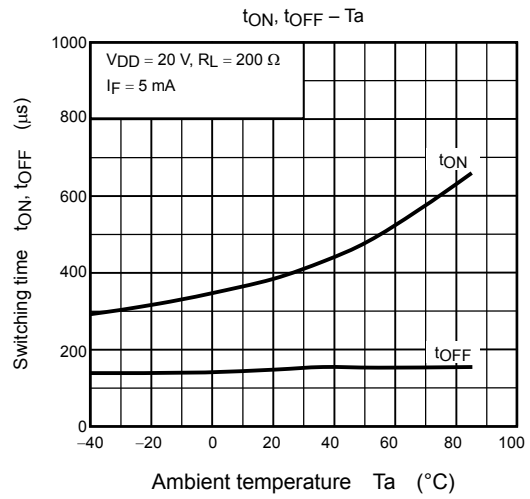
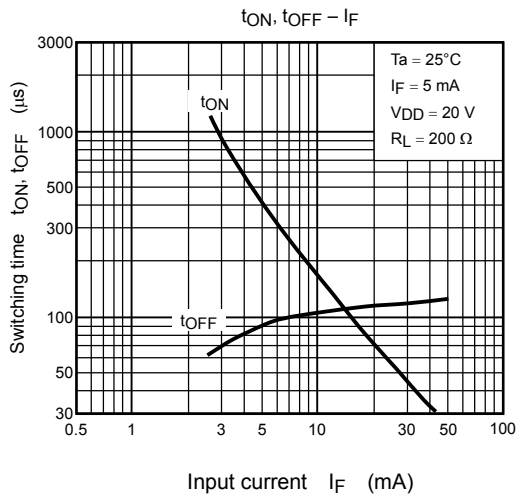

**RESTRICTIONS ON PRODUCT USE**

000707EBC

- TOSHIBA is continually working to improve the quality and reliability of its products. Nevertheless, semiconductor devices in general can malfunction or fail due to their inherent electrical sensitivity and vulnerability to physical stress. It is the responsibility of the buyer, when utilizing TOSHIBA products, to comply with the standards of safety in making a safe design for the entire system, and to avoid situations in which a malfunction or failure of such TOSHIBA products could cause loss of human life, bodily injury or damage to property.  
In developing your designs, please ensure that TOSHIBA products are used within specified operating ranges as set forth in the most recent TOSHIBA products specifications. Also, please keep in mind the precautions and conditions set forth in the "Handling Guide for Semiconductor Devices," or "TOSHIBA Semiconductor Reliability Handbook" etc..
- The TOSHIBA products listed in this document are intended for usage in general electronics applications (computer, personal equipment, office equipment, measuring equipment, industrial robotics, domestic appliances, etc.). These TOSHIBA products are neither intended nor warranted for usage in equipment that requires extraordinarily high quality and/or reliability or a malfunction or failure of which may cause loss of human life or bodily injury ("Unintended Usage"). Unintended Usage include atomic energy control instruments, airplane or spaceship instruments, transportation instruments, traffic signal instruments, combustion control instruments, medical instruments, all types of safety devices, etc.. Unintended Usage of TOSHIBA products listed in this document shall be made at the customer's own risk.
- Gallium arsenide (GaAs) is a substance used in the products described in this document. GaAs dust and fumes are toxic. Do not break, cut or pulverize the product, or use chemicals to dissolve them. When disposing of the products, follow the appropriate regulations. Do not dispose of the products with other industrial waste or with domestic garbage.
- The products described in this document are subject to the foreign exchange and foreign trade laws.
- The information contained herein is presented only as a guide for the applications of our products. No responsibility is assumed by TOSHIBA CORPORATION for any infringements of intellectual property or other rights of the third parties which may result from its use. No license is granted by implication or otherwise under any intellectual property or other rights of TOSHIBA CORPORATION or others.
- The information contained herein is subject to change without notice.