

TMC-5A31-xxx

High speed VCSEL TO-46 metal can

FEATURES:

- Industry standard TO-46 package with cap lens.
- Optimized for fiber optical communication with a monitor PD.
- Low dependence of electrical and optical characteristic over temperature.
- Symmetrical beam.
- High coupling efficiency to multi-mode fibers directly.
- Speed > 1 GHz.

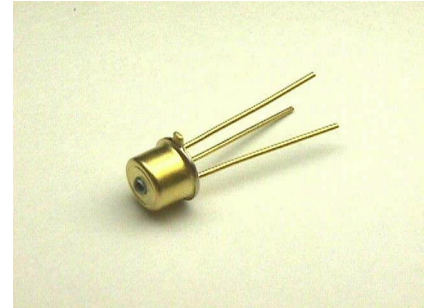

ELECTRO-OPTICAL CHARACTERISTICS:

PARAMETERS	SYMBOL	MIN	TYP	MAX	UNIT	TEST CONDITIONS ⁽¹⁾
Threshold Current	I_{th}		3	6	mA	
Output Power	P_o	1	2	3	mW	$I_F=12\text{ mA}$ ⁽²⁾
Operating Current	I_{OP}		12		mA	Adjustable to establish 1.5 mW output power
Slope Efficiency	η		0.25		mW/mA	$I_F=12\text{ mA}$ ⁽³⁾
Wavelength	λ_p	830	850	860	nm	$I_F=12\text{ mA}$
Forward Voltage	V_F	1.7	1.9	2.3	V	$I_F=12\text{ mA}$
Breakdown voltage	V_{BD}	10	15		V	$I_R=10\text{ }\mu\text{A}$
Series Resistance	R_S		40		Ω	$I_F=12\text{ mA}$
Monitor Current	I_M	10	25		uA	$V_R=5\text{ V}$, $P_o=1.5\text{ mW}$
Focal Length	F		0.7		mm	From the surface of lens

Notes:

1. All parameters except mentioned are measured at $I_F=12\text{ mA}$, 25°C , CW.
2. Higher power can be provided under request.
3. Slope efficiency is defined as $\Delta P/(12-I_{th})$ at 25°C .

THERMAL CHARACTERISTICS:

PARAMETERS	SYMBOL	MIN	TYP	MAX	UNIT	TEST CONDITIONS
Thermal Resistance	R_{th}		900		$^\circ\text{C}/\text{W}$	$T_A=25^\circ\text{C}$
I_{th} Temperature Variation	ΔI_{th}	-1		1	mA	$T_A=0\sim 70^\circ\text{C}$
V_F Temperature Coefficient	$\Delta V_F/\Delta T$		-2.5	-3.5	mV/ $^\circ\text{C}$	$T_A=0\sim 70^\circ\text{C}$, $I_F=12\text{ mA}$
η Temperature Coefficient	$\Delta\eta/\Delta T$		-0.15		%/ $^\circ\text{C}$	$T_A=0\sim 70^\circ\text{C}$, $I_F=12\text{ mA}$
λ_p Temperature Coefficient	$\Delta\lambda_p/\Delta T$		0.06		nm/ $^\circ\text{C}$	$T_A=0\sim 70^\circ\text{C}$, $I_F=12\text{ mA}$

ABSOLUTE MAXIMUM RATINGS:

PARAMETERS	MIN	MAX	UNIT	CONDITIONS
Storage Temperature	-40	125	$^\circ\text{C}$	
Operating Temperature	-20	85	$^\circ\text{C}$	
Lead Solder Temperature		260	$^\circ\text{C}$	5 seconds
Continuous Forward Current		40	mA	
Continuous Reverse Voltage		10	V	

Fig. 1 Typical Optical Characteristics

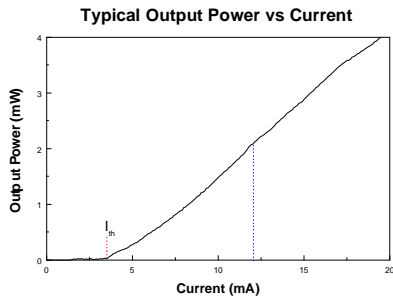

Fig. 2 Typical Electrical Characteristics

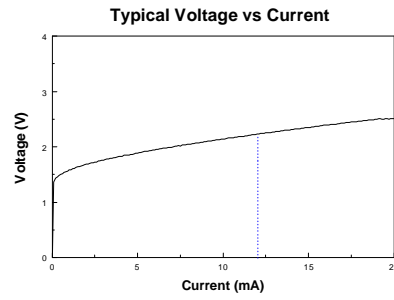
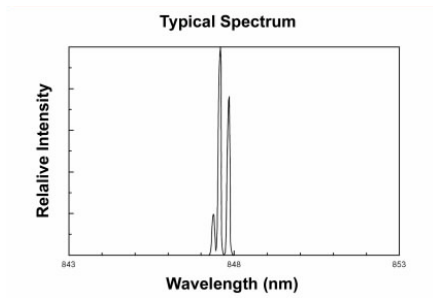
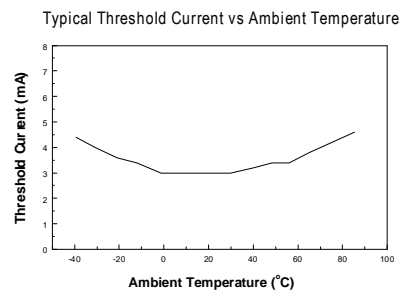

Fig. 3 Spectrum When Driving Current 15 mA



3 transverse modes typically.

Fig. 4 Temperature Dependence of Threshold Current



WARNING:

The VCSEL is a class IIIb laser in the safety standard ANSI Z136.1 and should be treated as a potential eye hazard.

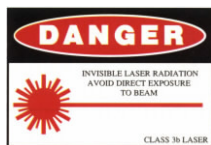

OUTLINE DIMENSIONS:

• Unit: mm

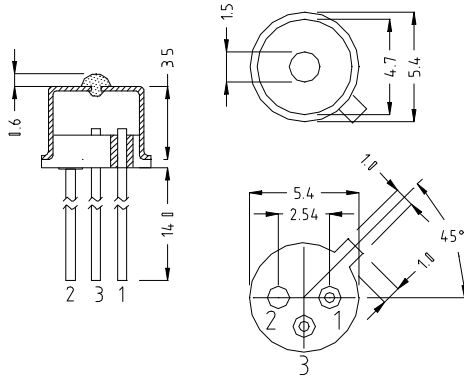

• PINOUT:

TMC-5A31-801

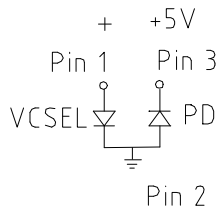

Pin 1: VCSEL Anode

Pin 2: VCSEL Cathode
PD Anode
Case

Pin 3: PD Cathode

TMC-5A31-802

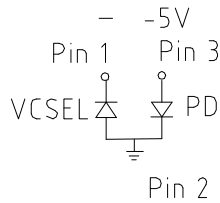

Pin 1: VCSEL Cathode

Pin 2: VCSEL Anode
PD Cathode
Case

Pin 3: PD Anode

TMC-5A31-803

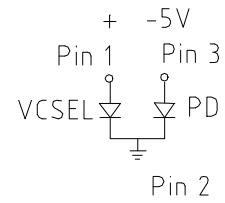

Pin 1: VCSEL Anode

Pin 2: VCSEL Cathode
PD Cathode
Case

Pin 3: PD Anode