



ULTRALOW-NOISE, HIGH PSRR, FAST RF 1-A LOW-DROPOUT LINEAR REGULATORS

FEATURES

- 1-A Low-Dropout Regulator With Enable
- Available in 1.8-V, 2.5-V, 2.8-V, 3-V, 3.3-V, and Adjustable (1.2-V to 5.5-V)
- High PSRR (53 dB at 10 kHz)
- Ultralow-Noise (40 μV_{RMS} , TPS79630)
- Fast Start-Up Time (50 μs)
- Stable With a 1- μF Ceramic Capacitor
- Excellent Load/Line Transient Response
- Very Low Dropout Voltage (250 mV at Full Load, TPS79630)
- 3 x 3 SON, 6-Pin SOT223-6, and 5-Pin DDPACK Packages

APPLICATIONS

- RF: VCOs, Receivers, ADCs
- Audio
- Bluetooth™, Wireless LAN
- Cellular and Cordless Telephones
- Handheld Organizers, PDAs

DESCRIPTION

The TPS796xx family of low-dropout (LDO) low-power linear voltage regulators features high power supply rejection ratio (PSRR), ultralow-noise, fast start-up, and excellent line and load transient responses in small outline, 3 x 3 SON, SOT223-6, and 5-pin DDPACK packages. Each device in the family is stable with a small 1- μF ceramic capacitor on the output. The family uses an advanced, proprietary BiCMOS fabrication process to yield extremely low dropout voltages (e.g., 250 mV at 1 A). Each device achieves fast start-up times (approximately 50 μs with a 0.001- μF bypass capacitor) while consuming very low quiescent current (265 μA typical). Moreover, when the device is placed in standby mode, the supply current is reduced to less than 1 μA . The TPS79630 exhibits approximately 40 μV_{RMS} of output voltage noise at 3.0-V output, with a 0.1- μF bypass capacitor. Applications with analog components that are noise sensitive, such as portable RF electronics, benefit from the high PSRR, low noise features, and the fast response time.

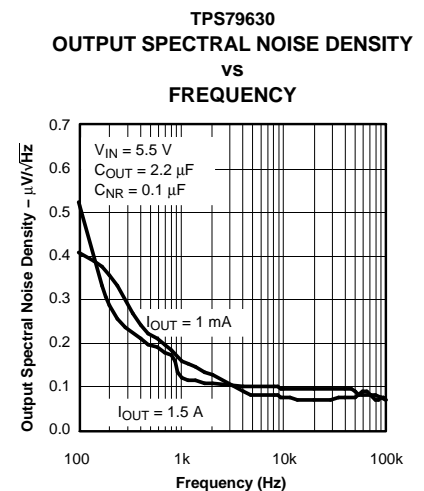
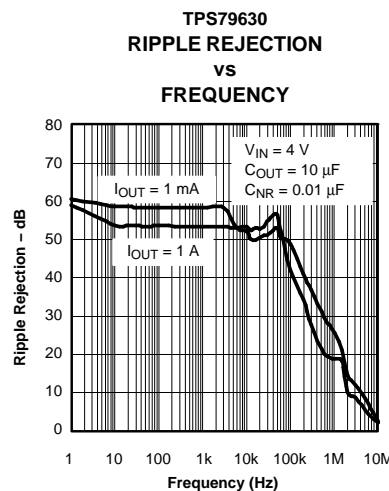
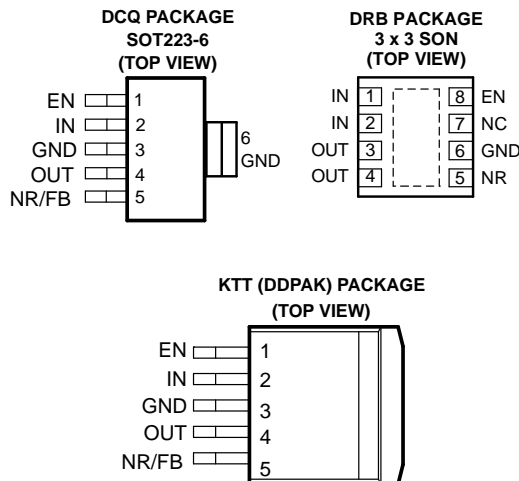

Please be aware that an important notice concerning availability, standard warranty, and use in critical applications of Texas Instruments semiconductor products and disclaimers thereto appears at the end of this data sheet.

Bluetooth is a trademark of Bluetooth SIG, Inc.
All other trademarks are the property of their respective owners.



This integrated circuit can be damaged by ESD. Texas Instruments recommends that all integrated circuits be handled with appropriate precautions. Failure to observe proper handling and installation procedures can cause damage.

ESD damage can range from subtle performance degradation to complete device failure. Precision integrated circuits may be more susceptible to damage because very small parametric changes could cause the device not to meet its published specifications.

AVAILABLE OPTIONS⁽¹⁾

PRODUCT	VOLTAGE	PACKAGE	T _J	SYMBOL	PART NUMBER	TRANSPORT MEDIA, QUANTITY
TPS79601	1.2 to 5.5 V	SOT223-6	-40°C to +125°C	PS79601	TPS79601DCQ	Tube, 78
					TPS79601DCQR	Tape and Reel, 2500
		DDPAK		TPS79601	TPS79601KTTT	Reel, 50
					TPS79601KTTR	Reel, 500
TPS79618	1.8 V	SOT223-6		PS79618	TPS79618DCQ	Tube, 78
					TPS79618DCQR	Tape and Reel, 2500
		DDPAK		TPS79618	TPS79618KTTT	Reel, 50
					TPS79618KTTR	Reel, 500
TPS79625	2.5 V	SOT223-6		PS79625	TPS79625DCQ	Tube, 78
					TPS79625DCQR	Tape and Reel, 2500
		DDPAK		TPS79625	TPS79625KTTT	Reel, 50
					TPS79625KTTR	Reel, 500
TPS79628	2.8 V	SOT223-6	PS79628	TPS79628DCQ	Tube, 78	
				TPS79628DCQR	Tape and Reel, 2500	
		DDPAK	TPS79628	TPS79628KTTT	Reel, 50	
				TPS79628KTTR	Reel, 500	
		3 x 3 SON	AMI	TPS79628DRB	Tube, 78	
				TPS79628DRBR	Tape and Reel, 2500	
				TPS79628DRBG4	Tube, 78	
				TPS79628DRBG4R	Tape and Reel, 2500	
TPS79630	3 V	SOT223-6	PS79630	TPS79630DCQ	Tube, 78	
				TPS79630DCQR	Tape and Reel, 2500	
		DDPAK	TPS79630	TPS79630KTTT	Reel, 50	
				TPS79630KTTR	Reel, 500	
TPS79633	3.3 V	SOT223-6	PS79633	TPS79633DCQ	Tube, 78	
				TPS79633DCQR	Tape and Reel, 2500	
		DDPAK	TPS79633	TPS79633KTTT	Reel, 50	
				TPS79633KTTR	Reel, 500	

(1) For the most current package and ordering information, see the Package Option Addendum located at the end of this datasheet.

ABSOLUTE MAXIMUM RATINGS

over operating temperature range (unless otherwise noted)⁽¹⁾

	UNIT
V _{IN} range	-0.3 V to 6 V
V _{EN} range	-0.3 V to V _{IN} + 0.3 V
V _{OUT} range	6 V
Peak output current	Internally limited
ESD rating, HBM	2 kV
ESD rating, CDM	500 V
Continuous total power dissipation	See Dissipation Ratings Table
Junction temperature range, T _J	-40°C to 150°C
Storage temperature range, T _{stg}	-65°C to 150°C

- (1) Stresses beyond those listed under *absolute maximum ratings* may cause permanent damage to the device. These are stress ratings only, and functional operation of the device at these or any other conditions beyond those indicated under *recommended operating conditions* is not implied. Exposure to absolute-maximum-rated conditions for extended periods may affect device reliability.

PACKAGE DISSIPATION RATINGS

PACKAGE	BOARD	R _{θJC}	R _{θJA}
DDPAK	High-K ⁽¹⁾	2 °C/W	23 °C/W
SOT223	Low-K ⁽²⁾	15 °C/W	53 °C/W
3 x 3 SON			56.2 °C/W

- (1) The JEDEC high-K (2s2p) board design used to derive this data was a 3-inch x 3-inch (7,5-cm x 7,5-cm), multilayer board with 1 ounce internal power and ground planes and 2 ounce copper traces on top and bottom of the board.
- (2) The JEDEC low-K (1s) board design used to derive this data was a 3-inch x 3-inch (7,5-cm x 7,5-cm), two-layer board with 2 ounce copper traces on top of the board.

ELECTRICAL CHARACTERISTICS

over recommended operating temperature range ($T_J = -40$ to 125°C), $V_{EN} = V_{IN}$, $V_{IN} = V_{OUT(nom)} + 1\text{ V}$, $I_{OUT} = 1\text{ mA}$, $C_{OUT} = 10\text{ }\mu\text{F}$, $C_{NR} = 0.01\text{ }\mu\text{F}$ (unless otherwise noted). Typical values are at $+25^\circ\text{C}$.

PARAMETER		TEST CONDITIONS		MIN	TYP	MAX	UNIT
V_{IN} Input voltage ⁽¹⁾				2.7		5.5	V
I_{OUT} Continuous output current ⁽¹⁾				0		1	A
Output voltage	TPS79618	$0\text{ }\mu\text{A} < I_{OUT} < 1\text{ A}$	$2.8\text{ V} < V_{IN} < 5.5\text{ V}$	1.764	1.8	1.836	V
	TPS79625	$0\text{ }\mu\text{A} < I_{OUT} < 1\text{ A}$	$3.5\text{ V} < V_{IN} < 5.5\text{ V}$	2.45	2.5	2.55	V
	TPS79628	$0\text{ }\mu\text{A} < I_{OUT} < 1\text{ A}$	$3.8\text{ V} < V_{IN} < 5.5\text{ V}$	2.744	2.8	2.856	
	TPS79630	$0\text{ }\mu\text{A} < I_{OUT} < 1\text{ A}$	$4\text{ V} < V_{IN} < 5.5\text{ V}$	2.94	3.0	3.06	
	TPS79633	$0\text{ }\mu\text{A} < I_{OUT} < 1\text{ A}$	$4.3\text{ V} < V_{IN} < 5.5\text{ V}$	3.234	3.3	3.366	
Output voltage line regulation ($\Delta V_{OUT}\%/V_{IN}$) ⁽¹⁾		$V_{OUT} + 1\text{ V} < V_{IN} \leq 5.5\text{ V}$			0.05	0.12	%/V
Load regulation ($\Delta V_{OUT}\%/\Delta I_{OUT}$)		$0\text{ }\mu\text{A} < I_{OUT} < 1\text{ A}$	$T_J = 25^\circ\text{C}$		5		mV
Dropout voltage ⁽²⁾ ($V_{IN} = V_{OUT(nom)} - 0.1\text{ V}$)	TPS79628	$I_{OUT} = 1\text{ A}$			270	365	mV
		$I_{OUT} = 250\text{ mA}$			67	90	
	TPS79630	$I_{OUT} = 1\text{ A}$			250	345	
		$I_{OUT} = 1\text{ A}$			220	325	
Output current limit		$V_{OUT} = 0\text{ V}$		2.4		4.2	A
Ground pin current		$0\text{ }\mu\text{A} < I_{OUT} < 1\text{ A}$			265	385	μA
Shutdown current ⁽³⁾		$V_{EN} = 0\text{ V}$, $2.7\text{ V} < V_{IN} < 5.5\text{ V}$			0.07	1	μA
FB pin current		FB = 1.8 V				1	μA
Power-supply ripple rejection	TPS79630	f = 100 Hz	$I_{OUT} = 10\text{ mA}$		59		dB
		f = 100 Hz	$I_{OUT} = 1\text{ A}$		54		
		f = 10 Hz	$I_{OUT} = 1\text{ A}$		53		
		f = 100 Hz	$I_{OUT} = 1\text{ A}$		42		
Output noise voltage (TPS79630)		BW = 100 Hz to 100 kHz, $I_{OUT} = 1\text{ A}$	$C_{NR} = 0.001\text{ }\mu\text{F}$		54		μV_{RMS}
			$C_{NR} = 0.0047\text{ }\mu\text{F}$		46		
			$C_{NR} = 0.01\text{ }\mu\text{F}$		41		
			$C_{NR} = 0.1\text{ }\mu\text{F}$		40		
Time, start-up (TPS79630)		$R_L = 3\text{ }\Omega$, $C_{OUT} = 1\text{ }\mu\text{F}$	$C_{NR} = 0.001\text{ }\mu\text{F}$		50		μs
			$C_{NR} = 0.0047\text{ }\mu\text{F}$		75		
			$C_{NR} = 0.01\text{ }\mu\text{F}$		110		
EN pin current		$V_{EN} = 0\text{ V}$		-1		1	μA
High-level enable input voltage		$2.7\text{ V} < V_{IN} < 5.5\text{ V}$		1.7		V_{IN}	V
Low-level enable input voltage		$2.7\text{ V} < V_{IN} < 5.5\text{ V}$		0		0.7	V

(1) Minimum $V_{IN} = V_{OUT} + V_{DO}$ or 2.7V, whichever is greater.

(2) V_{DO} is not measured for TPS79618 and TPS79625 because minimum $V_{IN} = 2.7\text{ V}$.

(3) For adjustable version, this applies only after V_{IN} is applied; then V_{EN} transitions high to low.

FUNCTIONAL BLOCK DIAGRAM—ADJUSTABLE VERSION

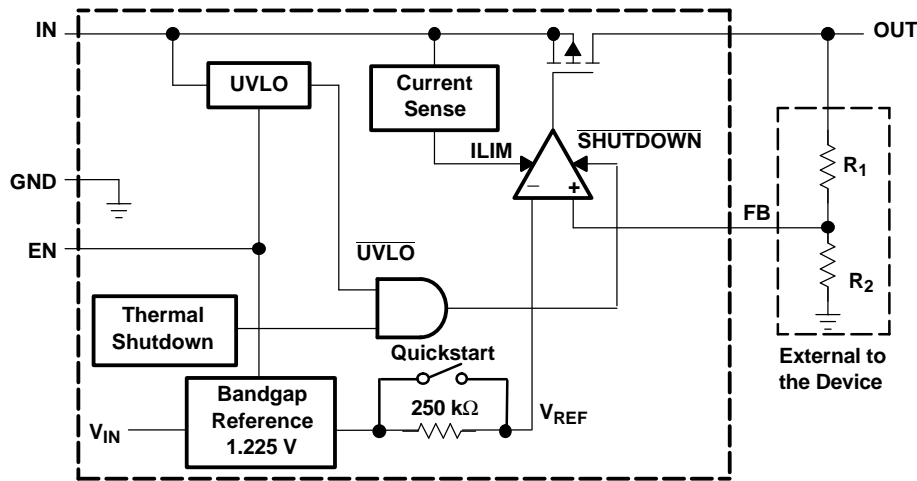

FUNCTIONAL BLOCK DIAGRAM—FIXED VERSION

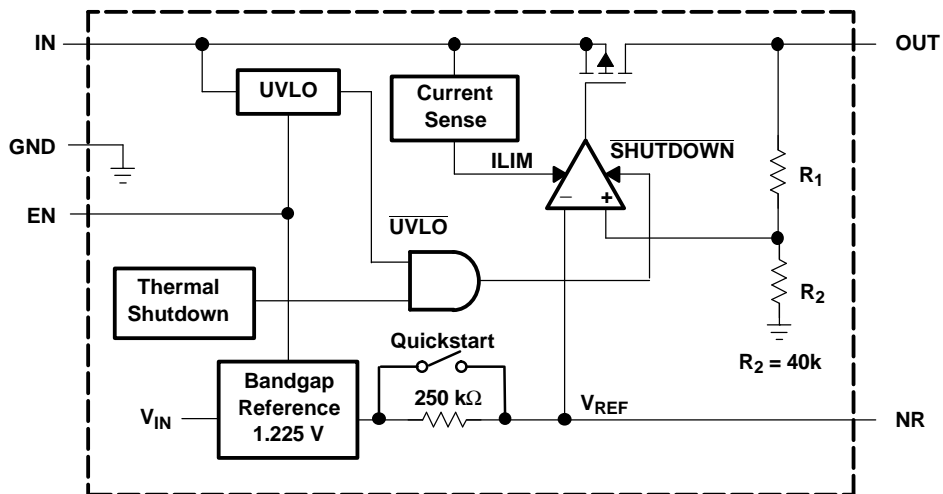

Table 1. Terminal Functions

TERMINAL NAME	TERMINAL		DESCRIPTION
	ADJ	FIXED	
NR	N/A	5	Connecting an external capacitor to this pin bypasses noise generated by the internal bandgap. This improves power-supply rejection and reduces output noise.
EN	1	1	Driving the enable pin (EN) high turns on the regulator. Driving this pin low puts the regulator into shutdown mode. EN can be connected to IN if not used.
FB	5	N/A	This terminal is the feedback input voltage for the adjustable device.
GND	3, Tab	3, Tab	Regulator ground
IN	2	2	Unregulated input to the device.
OUT	4	4	Output of the regulator.

TYPICAL CHARACTERISTICS

TPS79630
 OUTPUT VOLTAGE
 VS
 OUTPUT CURRENT

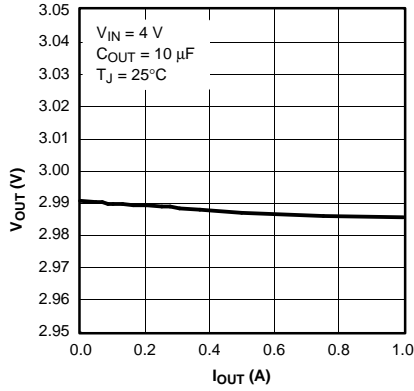

Figure 1.

TPS79628
 OUTPUT VOLTAGE
 VS
 JUNCTION TEMPERATURE

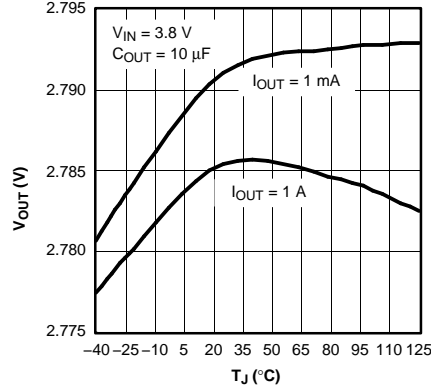

Figure 2.

TPS79628
 GROUND CURRENT
 VS
 JUNCTION TEMPERATURE

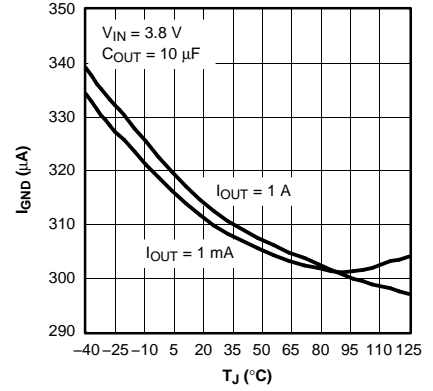

Figure 3.

TPS79630
 OUTPUT SPECTRAL NOISE DEN-
 SITY
 VS
 FREQUENCY

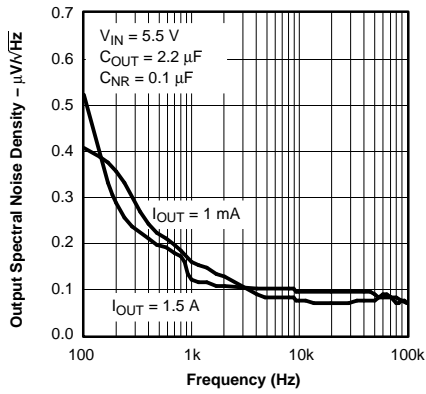

Figure 4.

TPS79630
 OUTPUT SPECTRAL NOISE DEN-
 SITY
 VS
 FREQUENCY

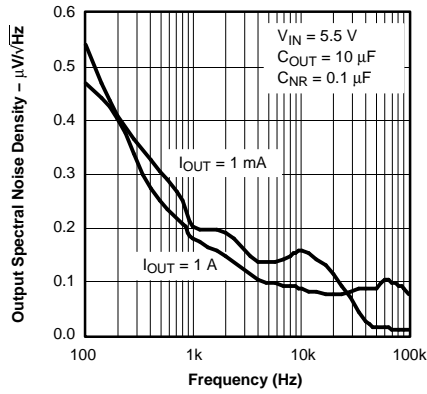

Figure 5.

TPS79630
 OUTPUT SPECTRAL NOISE DEN-
 SITY
 VS
 FREQUENCY

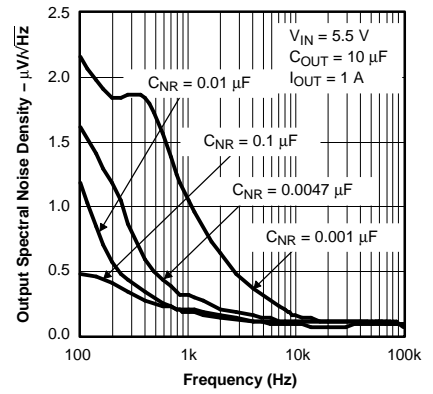

Figure 6.

TYPICAL CHARACTERISTICS (continued)

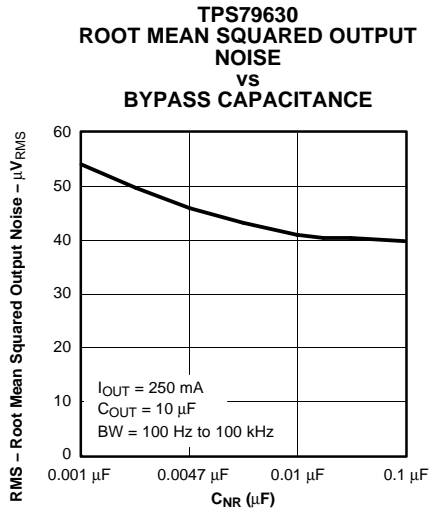

Figure 7.

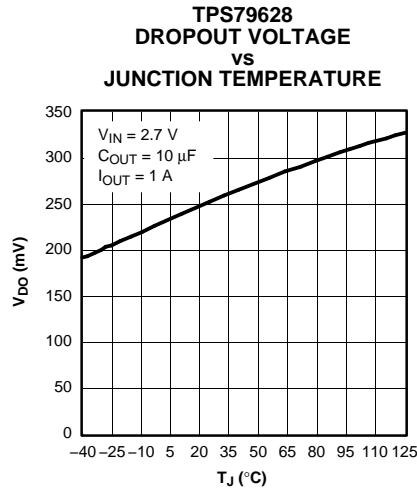

Figure 8.

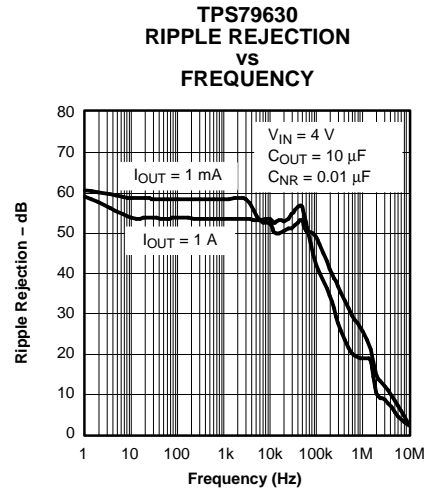

Figure 9.

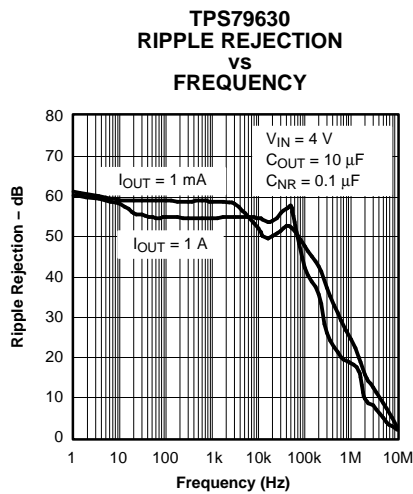

Figure 10.

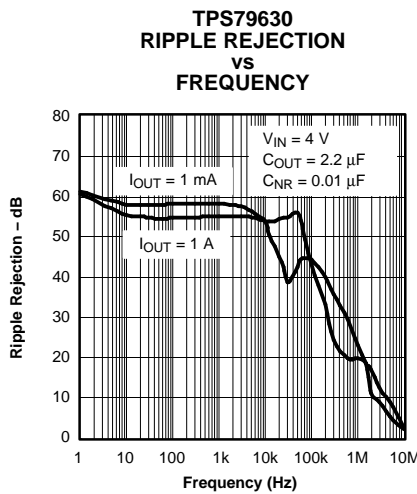

Figure 11.

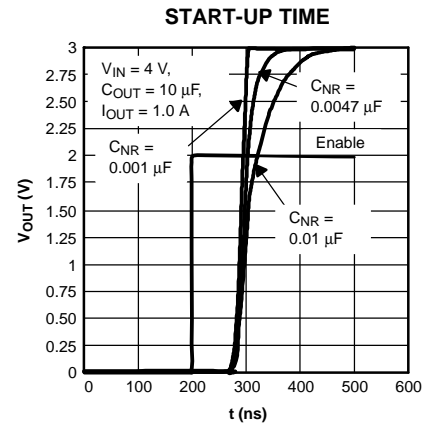

Figure 12.

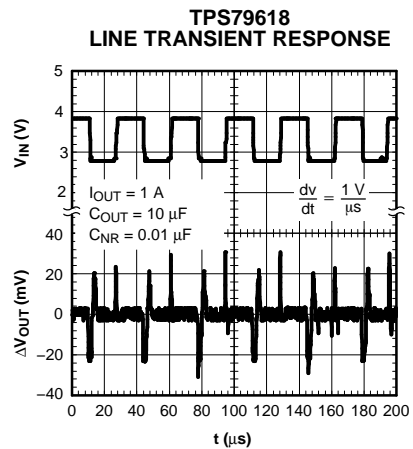

Figure 13.

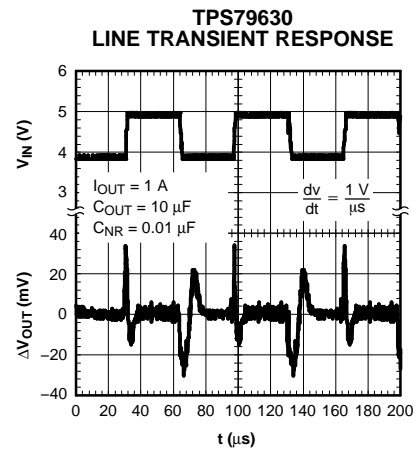

Figure 14.

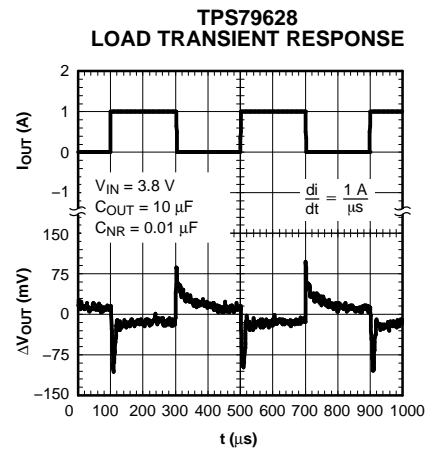

Figure 15.

TYPICAL CHARACTERISTICS (continued)

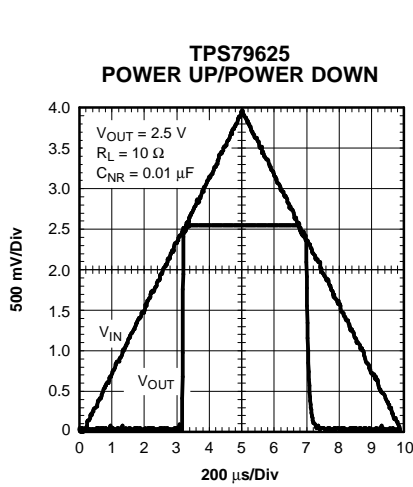

Figure 16.

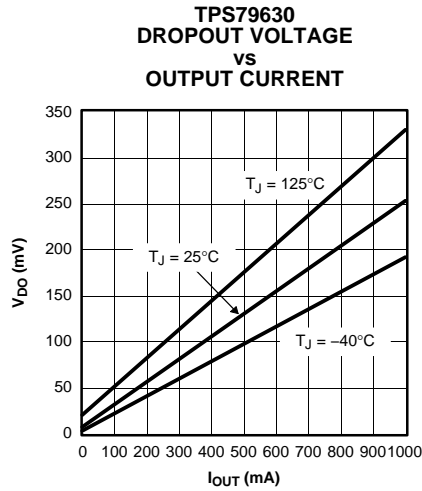

Figure 17.

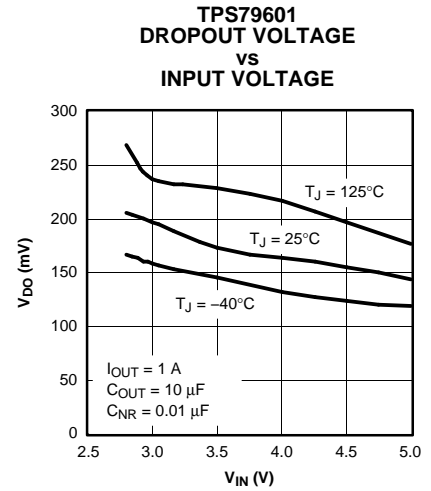

Figure 18.

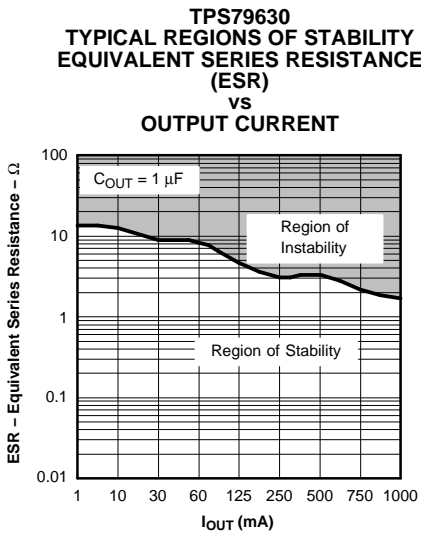

Figure 19.

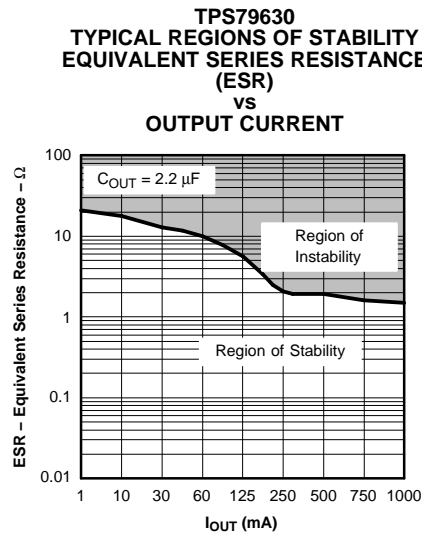

Figure 20.

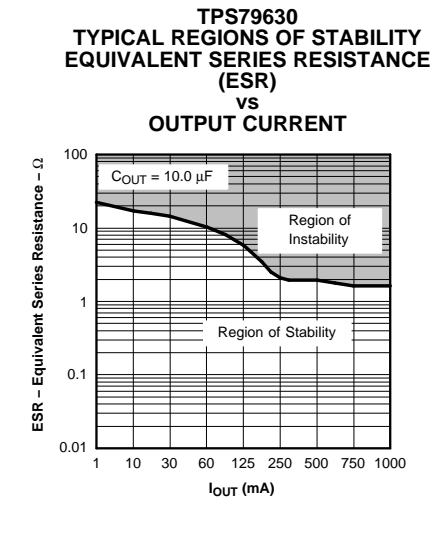

Figure 21.

APPLICATION INFORMATION

The TPS796xx family of low-dropout (LDO) regulators has been optimized for use in noise-sensitive equipment. The device features extremely low dropout voltages, high PSRR, ultralow output noise, low quiescent current (265 μA typically), and enable input to reduce supply currents to less than 1 μA when the regulator is turned off.

A typical application circuit is shown in Figure 22.

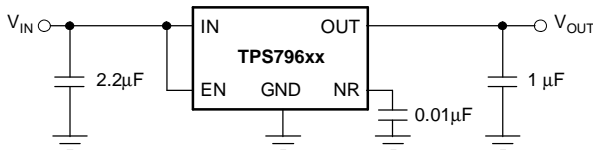

Figure 22. Typical Application Circuit

External Capacitor Requirements

Although not required, it is good analog design practice to place a 0.1- μF — 2.2- μF capacitor near the input of the regulator to counteract reactive input sources. A 2.2- μF or larger ceramic input bypass capacitor, connected between IN and GND and located close to the TPS796xx, is required for stability and improves transient response, noise rejection, and ripple rejection. A higher-value input capacitor may be necessary if large, fast-rise-time load transients are anticipated and the device is located several inches from the power source.

Like most low dropout regulators, the TPS796xx requires an output capacitor connected between OUT and GND to stabilize the internal control loop. The minimum recommended capacitance is 1 μF . Any 1 μF or larger ceramic capacitor is suitable.

The internal voltage reference is a key source of noise in an LDO regulator. The TPS796xx has an NR pin which is connected to the voltage reference through a 250-k Ω internal resistor. The 250-k Ω internal resistor, in conjunction with an external bypass capacitor connected to the NR pin, creates a low-pass filter to reduce the voltage reference noise and, therefore, the noise at the regulator output. In order for the regulator to operate properly, the current flow out of the NR pin must be at a minimum, because any leakage current creates an IR drop across the internal resistor, thus creating an output error. Therefore, the bypass capacitor must have minimal leakage current. The bypass capacitor should be no more than 0.1- μF in order to ensure that it is fully charged during the quickstart time provided by the internal switch shown in the functional block diagram.

For example, the TPS79630 exhibits 40 μV_{RMS} of output voltage noise using a 0.1- μF ceramic bypass capacitor and a 10- μF ceramic output capacitor. Note that the output starts up slower as the bypass capacitance increases due to the RC time constant at the bypass pin that is created by the internal 250-k Ω resistor and external capacitor.

Board Layout Recommendation to Improve PSRR and Noise Performance

To improve ac measurements like PSRR, output noise, and transient response, it is recommended that the board be designed with separate ground planes for V_{IN} and V_{OUT} , with each ground plane connected only at the ground pin of the device. In addition, the ground connection for the bypass capacitor should connect directly to the ground pin of the device.

Regulator Mounting

The tab of the SOT223-6 package is electrically connected to ground. For best thermal performance, the tab of the surface-mount version should be soldered directly to a circuit-board copper area. Increasing the copper area improves heat dissipation.

Solder pad footprint recommendations for the devices are presented in an application bulletin *Solder Pad Recommendations for Surface-Mount Devices*, literature number AB-132, available for download from the TI web site (www.ti.com).

Programming the TPS79601 Adjustable LDO Regulator

The output voltage of the TPS79601 adjustable regulator is programmed using an external resistor divider as shown in Figure 28. The output voltage is calculated using Equation 1:

$$V_{\text{O}} = V_{\text{REF}} \times \left(1 + \frac{R1}{R2} \right) \quad (1)$$

where:

- $V_{\text{REF}} = 1.2246 \text{ V typ}$ (the internal reference voltage)

Resistors R1 and R2 should be chosen for approximately 40- μA divider current. Lower value resistors can be used for improved noise performance, but the device wastes more power. Higher values should be avoided, as leakage current at FB increases the output voltage error.

The recommended design procedure is to choose $R2 = 30.1 \text{ k}\Omega$ to set the divider current at $40 \text{ }\mu\text{A}$, $C1 = 15 \text{ pF}$ for stability, and then calculate $R1$ using Equation 2:

$$R1 = \left(\frac{V_O}{V_{REF}} - 1 \right) \times R2 \quad (2)$$

In order to improve the stability of the adjustable version, it is suggested that a small compensation capacitor be placed between OUT and FB. The approximate value of this capacitor can be calculated as Equation 3:

$$C1 = \frac{(3 \times 10^{-7}) \times (R1 + R2)}{(R1 \times R2)} \quad (3)$$

The suggested value of this capacitor for several resistor ratios is shown in the table below (see Figure 23). If this capacitor is not used (such as in a unity-gain configuration) then the minimum recommended output capacitor is $2.2 \text{ }\mu\text{F}$ instead of $1 \text{ }\mu\text{F}$.

Regulator Protection

The TPS796xx PMOS-pass transistor has a built-in back diode that conducts reverse current when the input voltage drops below the output voltage (e.g., during power down). Current is conducted from the output to the input and is not internally limited. If extended reverse voltage operation is anticipated, external limiting might be appropriate.

The TPS796xx features internal current limiting and thermal protection. During normal operation, the TPS796xx limits output current to approximately 2.8 A. When current limiting engages, the output voltage scales back linearly until the overcurrent condition ends. While current limiting is designed to prevent gross device failure, care should be taken not to exceed the power dissipation ratings of the package. If the temperature of the device exceeds approximately 165°C , thermal-protection circuitry shuts it down. Once the device has cooled down to below approximately 140°C , regulator operation resumes.

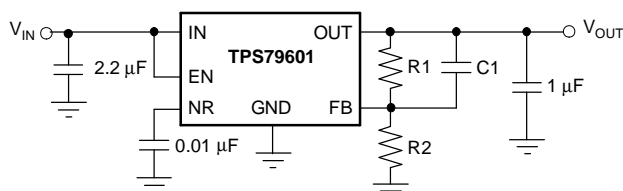

**OUTPUT VOLTAGE
 PROGRAMMING GUIDE**

OUTPUT VOLTAGE	R1	R2	C1
1.8 V	14.0 k Ω	30.1 k Ω	33 pF
3.6V	57.9 k Ω	30.1 k Ω	15 pF

Figure 23. TPS79601 Adjustable LDO Regulator Programming

THERMAL INFORMATION

The amount of heat that an LDO linear regulator generates is directly proportional to the amount of power it dissipates during operation. All integrated circuits have a maximum allowable junction temperature (T_{Jmax}) above which normal operation is not assured. A system designer must design the operating environment so that the operating junction temperature (T_J) does not exceed the maximum junction temperature (T_{Jmax}). The two main environmental variables that a designer can use to improve thermal performance are air flow and external heatsinks. The purpose of this information is to aid the designer in determining the proper operating environment for a linear regulator that is operating at a specific power level.

In general, the maximum expected power ($P_{D(max)}$) consumed by a linear regulator is computed as Equation 4:

$$P_{Dmax} = (V_{I(avg)} - V_{O(avg)}) \times I_{O(avg)} + V_{I(avg)} \times I_{(Q)} \quad (4)$$

where:

- $V_{I(avg)}$ is the average input voltage.
- $V_{O(avg)}$ is the average output voltage.
- $I_{O(avg)}$ is the average output current.
- $I_{(Q)}$ is the quiescent current.

For most TI LDO regulators, the quiescent current is insignificant compared to the average output current; therefore, the term $V_{I(avg)} \times I_{(Q)}$ can be neglected. The operating junction temperature is computed by adding the ambient temperature (T_A) and the increase in

temperature due to the regulator's power dissipation. The temperature rise is computed by multiplying the maximum expected power dissipation by the sum of the thermal resistances between the junction and the case ($R_{\theta JC}$), the case to heatsink ($R_{\theta CS}$), and the heatsink to ambient ($R_{\theta SA}$). Thermal resistances are measures of how effectively an object dissipates heat. Typically, the larger the device, the more surface area available for power dissipation and the lower the object's thermal resistance.

Figure 24 illustrates these thermal resistances for (a) a SOT223 package mounted in a JEDEC low-K board, and (b) a DDPAK package mounted on a JEDEC high-K board.

Equation 5 summarizes the computation:

$$T_J = T_A + P_{Dmax} \times (R_{\theta JC} + R_{\theta CS} + R_{\theta SA}) \quad (5)$$

The $R_{\theta JC}$ is specific to each regulator as determined by its package, lead frame, and die size provided in the regulator's data sheet. The $R_{\theta SA}$ is a function of the type and size of heatsink. For example, *black body radiator* type heatsinks can have $R_{\theta CS}$ values ranging from 5°C/W for very large heatsinks to 50°C/W for very small heatsinks. The $R_{\theta CS}$ is a function of how the package is attached to the heatsink. For example, if a thermal compound is used to attach a heatsink to a SOT223 package, $R_{\theta CS}$ of 1°C/W is reasonable.

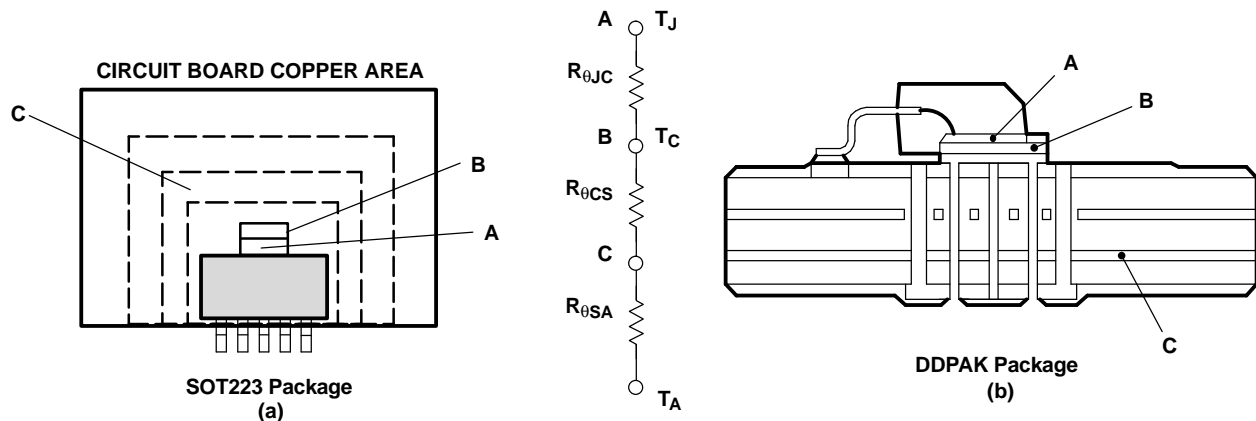

Figure 24. Thermal Resistances

Even if no external *black body radiator* type heatsink is attached to the package, the board on which the regulator is mounted provides some heatsinking through the pin solder connections. Some packages, like the DDPAK and SOT223 packages, use a copper plane underneath the package or the circuit board's ground plane for additional heatsinking to improve their thermal performance. Computer-aided thermal modeling can be used to compute very accurate approximations of an integrated circuit's thermal performance in different operating environments (e.g., different types of circuit boards, different types and sizes of heatsinks, and different air flows, etc.). Using these models, the three thermal resistances can be combined into one thermal resistance between junction and ambient ($R_{\theta JA}$). This $R_{\theta JA}$ is valid only for the specific operating environment used in the computer model.

Equation 5 simplifies into Equation 6:

$$T_J = T_A + P_{D,max} \times R_{\theta JA} \quad (6)$$

Rearranging Equation 6 gives Equation 7:

$$R_{\theta JA} = \frac{T_J - T_A}{P_{D,max}} \quad (7)$$

Using Equation 6 and the computer model generated curves shown in Figure 25 and Figure 28, a designer can quickly compute the required heatsink thermal resistance/board area for a given ambient temperature, power dissipation, and operating environment.

DDPAK Power Dissipation

The DDPAK package provides an effective means of managing power dissipation in surface mount applications. The DDPAK package dimensions are provided in the *Mechanical Data* section at the end of the data sheet. The addition of a copper plane directly underneath the DDPAK package enhances the thermal performance of the package.

To illustrate, the TPS72525 in a DDPAK package was chosen. For this example, the average input voltage is 5 V, the output voltage is 2.5 V, the average output current is 1 A, the ambient temperature 55°C, the air flow is 150 LFM, and the operating environment is the same as documented below. Neglecting the quiescent current, the maximum average power is calculated as Equation 8:

$$P_{D,max} = (5 - 2.5) \text{ V} \times 1 \text{ A} = 2.5 \text{ W} \quad (8)$$

Substituting $T_{J,max}$ for T_J into Equation 6 gives Equation 9:

$$R_{\theta JA,max} = (125 - 55)^\circ\text{C} / 2.5 \text{ W} = 28^\circ\text{C/W} \quad (9)$$

From Figure 25, DDPAK Thermal Resistance vs Copper Heatsink Area, the ground plane needs to be 1 cm² for the part to dissipate 2.5 W. The operating environment used in the computer model to construct Figure 25 consisted of a standard JEDEC High-K board (2S2P) with a 1 oz. internal copper plane and ground plane. The package is soldered to a 2 oz. copper pad. The pad is tied through thermal vias to the 1 oz. ground plane. Figure 26 shows the side view of the operating environment used in the computer model.

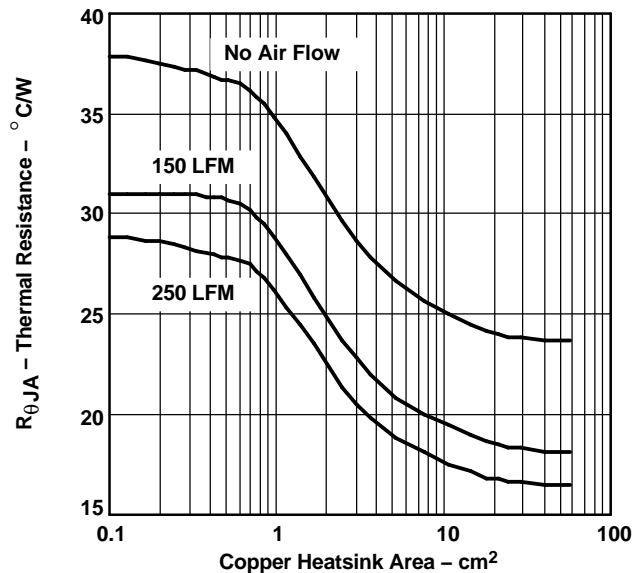

Figure 25. DDPAK Thermal Resistance vs Copper Heatsink Area

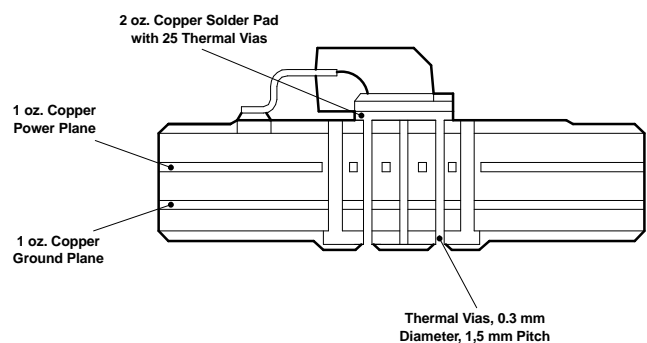

Figure 26. DDPAK Thermal Resistance

From the data in Figure 27 and rearranging Equation 6, the maximum power dissipation for a different ground plane area and a specific ambient temperature can be computed.

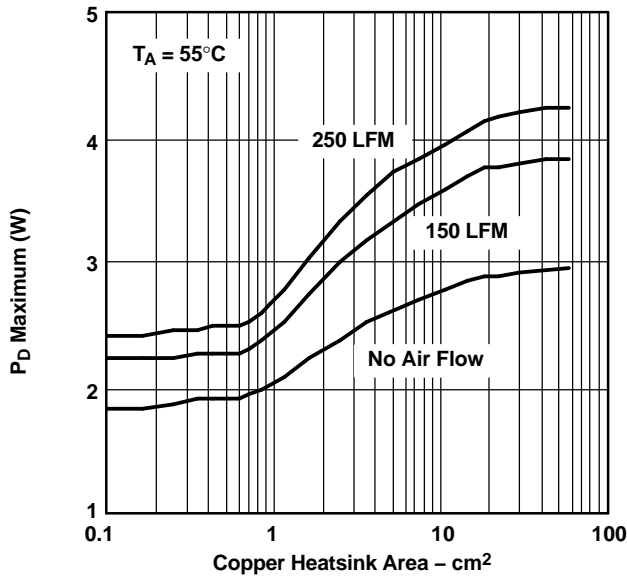

Figure 27. Maximum Power Dissipation vs Copper Heatsink Area

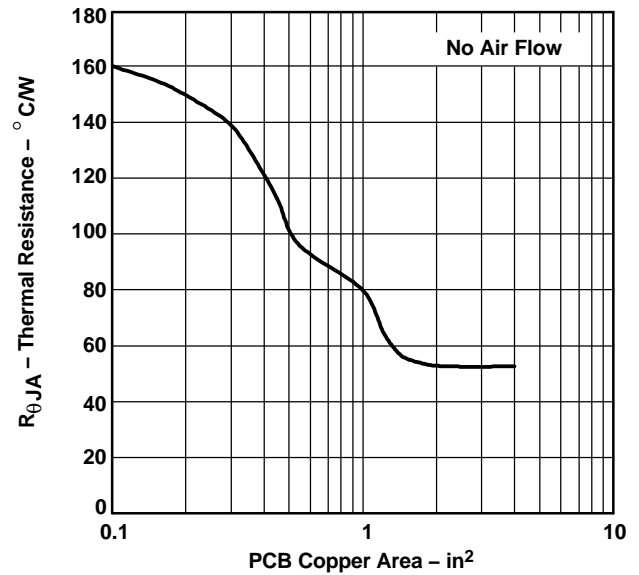

Figure 28. SOT223 Thermal Resistance vs PCB Area

SOT223 Power Dissipation

The SOT223 package provides an effective means of managing power dissipation in surface mount applications. The SOT223 package dimensions are provided in the *Mechanical Data* section at the end of the data sheet. The addition of a copper plane directly underneath the SOT223 package enhances the thermal performance of the package.

To illustrate, the TPS72525 in a SOT223 package was chosen. For this example, the average input voltage is 3.3 V, the output voltage is 2.5 V, the average output current is 1 A, the ambient temperature 55°C, no air flow is present, and the operating environment is the same as documented below. Neglecting the quiescent current, the maximum average power is calculated as Equation 10:

$$P_{D,max} = (3.3 - 2.5) V \times 1 A = 800 \text{ mW} \quad (10)$$

Substituting $T_{j,max}$ for T_j into Equation 6 gives Equation 11:

$$R_{\theta JA,max} = (125 - 55)^\circ\text{C}/800 \text{ mW} = 87.5^\circ\text{C}/\text{W} \quad (11)$$

From Figure 28, $R_{\theta JA}$ vs PCB Copper Area, the ground plane needs to be 0.55 in² for the part to dissipate 800 mW. The operating environment used to construct Figure 28 consisted of a board with 1 oz. copper planes. The package is soldered to a 1 oz. copper pad on the top of the board. The pad is tied through thermal vias to the 1 oz. ground plane.

From the data in Figure 28 and rearranging Equation 6, the maximum power dissipation for a different ground plane area and a specific ambient temperature can be computed (see Figure 29).

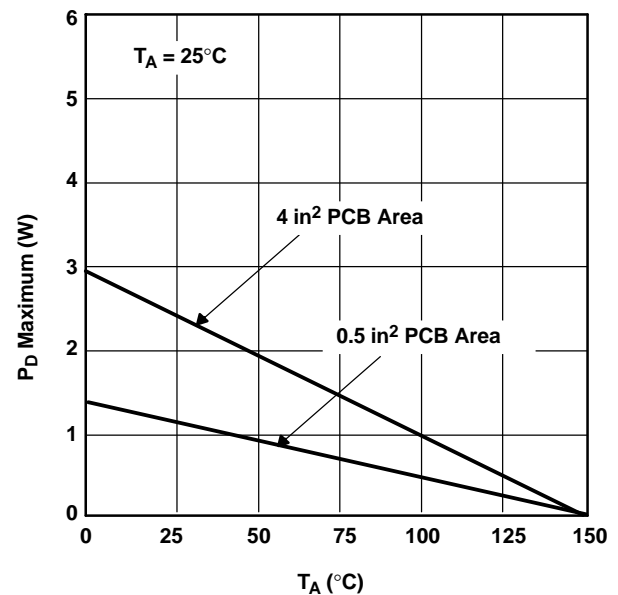

Figure 29. SOT223 Power Dissipation

PACKAGING INFORMATION

Orderable Device	Status ⁽¹⁾	Package Type	Package Drawing	Pins	Package Qty	Eco Plan ⁽²⁾	Lead/Ball Finish	MSL Peak Temp ⁽³⁾
TPS79601DCQ	ACTIVE	SOP	DCQ	6	78	None	Call TI	Level-3-235C-168 HR
TPS79601DCQR	ACTIVE	SOP	DCQ	6	2500	None	Call TI	Level-3-235C-168 HR
TPS79601KTT	OBSOLETE	DDPAK/ TO-263	KTT	5		None	Call TI	Call TI
TPS79601KTTR	ACTIVE	DDPAK/ TO-263	KTT	5	500	None	Call TI	Level-3-240C-168 HR
TPS79601KTTT	ACTIVE	DDPAK/ TO-263	KTT	5	50	None	Call TI	Level-3-240C-168 HR
TPS79618DCQ	ACTIVE	SOP	DCQ	6	78	None	Call TI	Level-3-235C-168 HR
TPS79618DCQR	ACTIVE	SOP	DCQ	6	2500	None	Call TI	Level-3-235C-168 HR
TPS79618KTT	OBSOLETE	DDPAK/ TO-263	KTT	5		None	Call TI	Call TI
TPS79618KTTR	ACTIVE	DDPAK/ TO-263	KTT	5	500	None	Call TI	Level-3-240C-168 HR
TPS79618KTTT	ACTIVE	DDPAK/ TO-263	KTT	5	50	None	Call TI	Level-3-240C-168 HR
TPS79625DCQ	ACTIVE	SOP	DCQ	6	78	None	Call TI	Level-3-235C-168 HR
TPS79625DCQR	ACTIVE	SOP	DCQ	6	2500	None	Call TI	Level-3-235C-168 HR
TPS79625KTT	OBSOLETE	DDPAK/ TO-263	KTT	5		None	Call TI	Call TI
TPS79625KTTR	ACTIVE	DDPAK/ TO-263	KTT	5	500	None	Call TI	Level-3-240C-168 HR
TPS79625KTTT	ACTIVE	DDPAK/ TO-263	KTT	5	50	None	Call TI	Level-3-240C-168 HR
TPS79628DCQ	ACTIVE	SOP	DCQ	6	78	None	Call TI	Level-3-235C-168 HR
TPS79628DCQR	ACTIVE	SOP	DCQ	6	2500	None	Call TI	Level-3-235C-168 HR
TPS79628KTT	OBSOLETE	DDPAK/ TO-263	KTT	5		None	Call TI	Call TI
TPS79628KTTR	ACTIVE	DDPAK/ TO-263	KTT	5	500	None	Call TI	Level-3-240C-168 HR
TPS79628KTTT	ACTIVE	DDPAK/ TO-263	KTT	5	50	None	Call TI	Level-3-240C-168 HR
TPS79630DCQ	ACTIVE	SOP	DCQ	6	78	None	Call TI	Level-3-235C-168 HR
TPS79630DCQR	ACTIVE	SOP	DCQ	6	2500	None	Call TI	Level-3-235C-168 HR
TPS79630KTT	OBSOLETE	DDPAK/ TO-263	KTT	5		None	Call TI	Call TI
TPS79630KTTR	ACTIVE	DDPAK/ TO-263	KTT	5	500	None	Call TI	Level-3-240C-168 HR
TPS79630KTTT	ACTIVE	DDPAK/ TO-263	KTT	5	50	None	Call TI	Level-3-240C-168 HR
TPS79633DCQ	ACTIVE	SOP	DCQ	6	78	None	Call TI	Level-3-235C-168 HR
TPS79633DCQR	ACTIVE	SOP	DCQ	6	2500	None	Call TI	Level-3-235C-168 HR
TPS79633KTT	OBSOLETE	DDPAK/ TO-263	KTT	5		None	Call TI	Call TI
TPS79633KTTR	ACTIVE	DDPAK/ TO-263	KTT	5	500	None	Call TI	Level-3-240C-168 HR
TPS79633KTTT	ACTIVE	DDPAK/ TO-263	KTT	5	50	None	Call TI	Level-3-240C-168 HR

Orderable Device	Status ⁽¹⁾	Package Type	Package Drawing	Pins	Package Qty	Eco Plan ⁽²⁾	Lead/Ball Finish	MSL Peak Temp ⁽³⁾
TO-263								

⁽¹⁾ The marketing status values are defined as follows:

ACTIVE: Product device recommended for new designs.

LIFEBUY: TI has announced that the device will be discontinued, and a lifetime-buy period is in effect.

NRND: Not recommended for new designs. Device is in production to support existing customers, but TI does not recommend using this part in a new design.

PREVIEW: Device has been announced but is not in production. Samples may or may not be available.

OBSOLETE: TI has discontinued the production of the device.

⁽²⁾ Eco Plan - May not be currently available - please check <http://www.ti.com/productcontent> for the latest availability information and additional product content details.

None: Not yet available Lead (Pb-Free).

Pb-Free (RoHS): TI's terms "Lead-Free" or "Pb-Free" mean semiconductor products that are compatible with the current RoHS requirements for all 6 substances, including the requirement that lead not exceed 0.1% by weight in homogeneous materials. Where designed to be soldered at high temperatures, TI Pb-Free products are suitable for use in specified lead-free processes.

Green (RoHS & no Sb/Br): TI defines "Green" to mean "Pb-Free" and in addition, uses package materials that do not contain halogens, including bromine (Br) or antimony (Sb) above 0.1% of total product weight.

⁽³⁾ MSL, Peak Temp. -- The Moisture Sensitivity Level rating according to the JEDEC industry standard classifications, and peak solder temperature.

Important Information and Disclaimer: The information provided on this page represents TI's knowledge and belief as of the date that it is provided. TI bases its knowledge and belief on information provided by third parties, and makes no representation or warranty as to the accuracy of such information. Efforts are underway to better integrate information from third parties. TI has taken and continues to take reasonable steps to provide representative and accurate information but may not have conducted destructive testing or chemical analysis on incoming materials and chemicals. TI and TI suppliers consider certain information to be proprietary, and thus CAS numbers and other limited information may not be available for release.

In no event shall TI's liability arising out of such information exceed the total purchase price of the TI part(s) at issue in this document sold by TI to Customer on an annual basis.

DCQ (R-PDSO-G6)

PLASTIC SMALL-OUTLINE

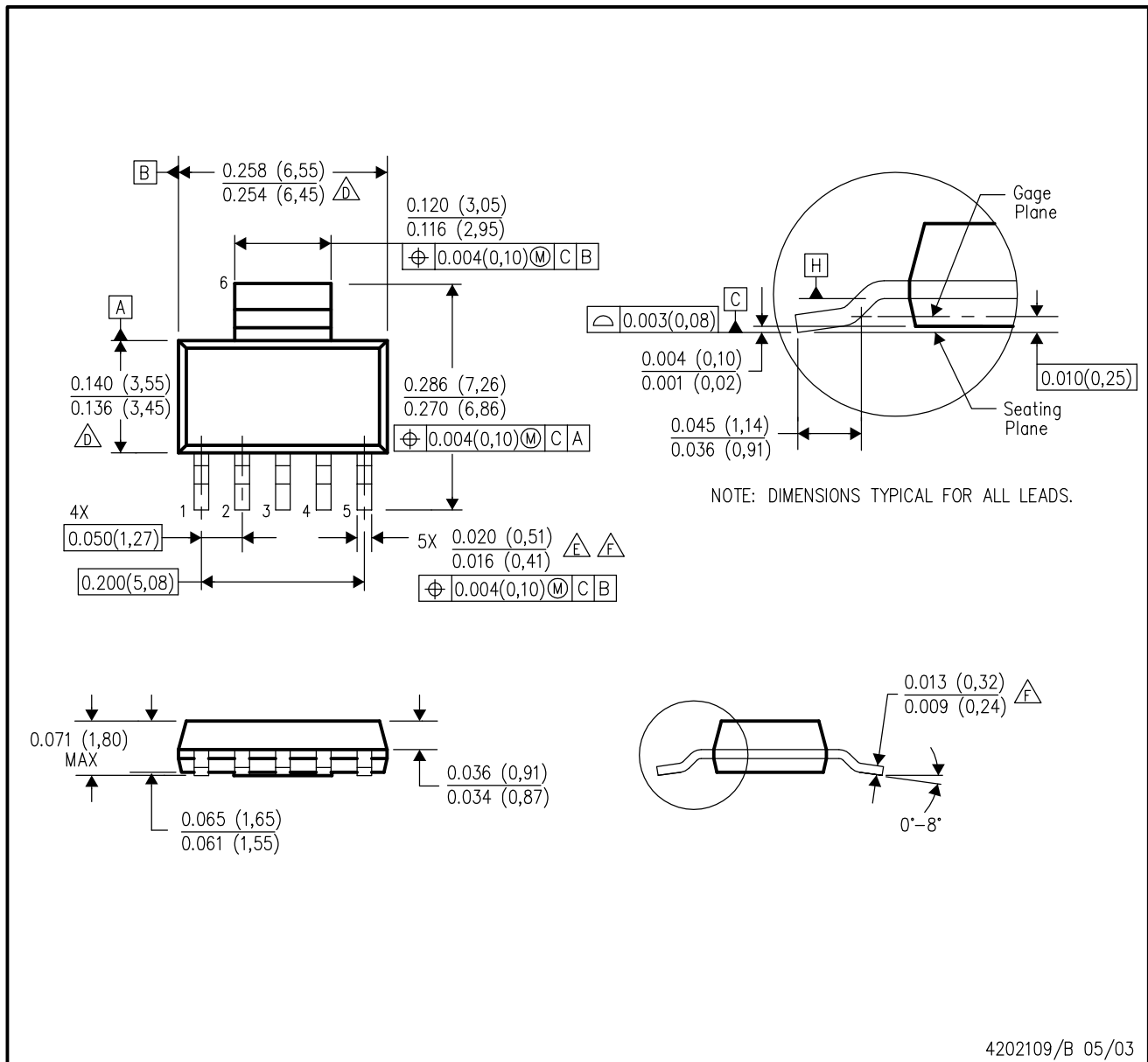

- NOTES:
- A. All linear dimensions are in inches (millimeters).
 - B. This drawing is subject to change without notice.
 - C. Controlling dimension in inches.
 - $\triangle D$ Body length and width dimensions are determined at the outermost extremes of the plastic body exclusive of mold flash, tie bar burrs, gate burrs, and interlead flash, but including any mismatch between the top and the bottom of the plastic body.
 - $\triangle E$ Lead width dimension does not include dambar protrusion.
 - $\triangle F$ Lead width and thickness dimensions apply to solder plated leads.
 - G. Interlead flash allow 0.008 inch max.
 - H. Gate burr/protrusion max. 0.006 inch.
 - I. Datums A and B are to be determined at Datum H.
 - J. Package dimensions per JEDEC outline drawing TO-261, issue B, dated Feb. 1999. This variation is not yet included.

KTT (R-PSFM-G5)

PLASTIC FLANGE-MOUNT PACKAGE

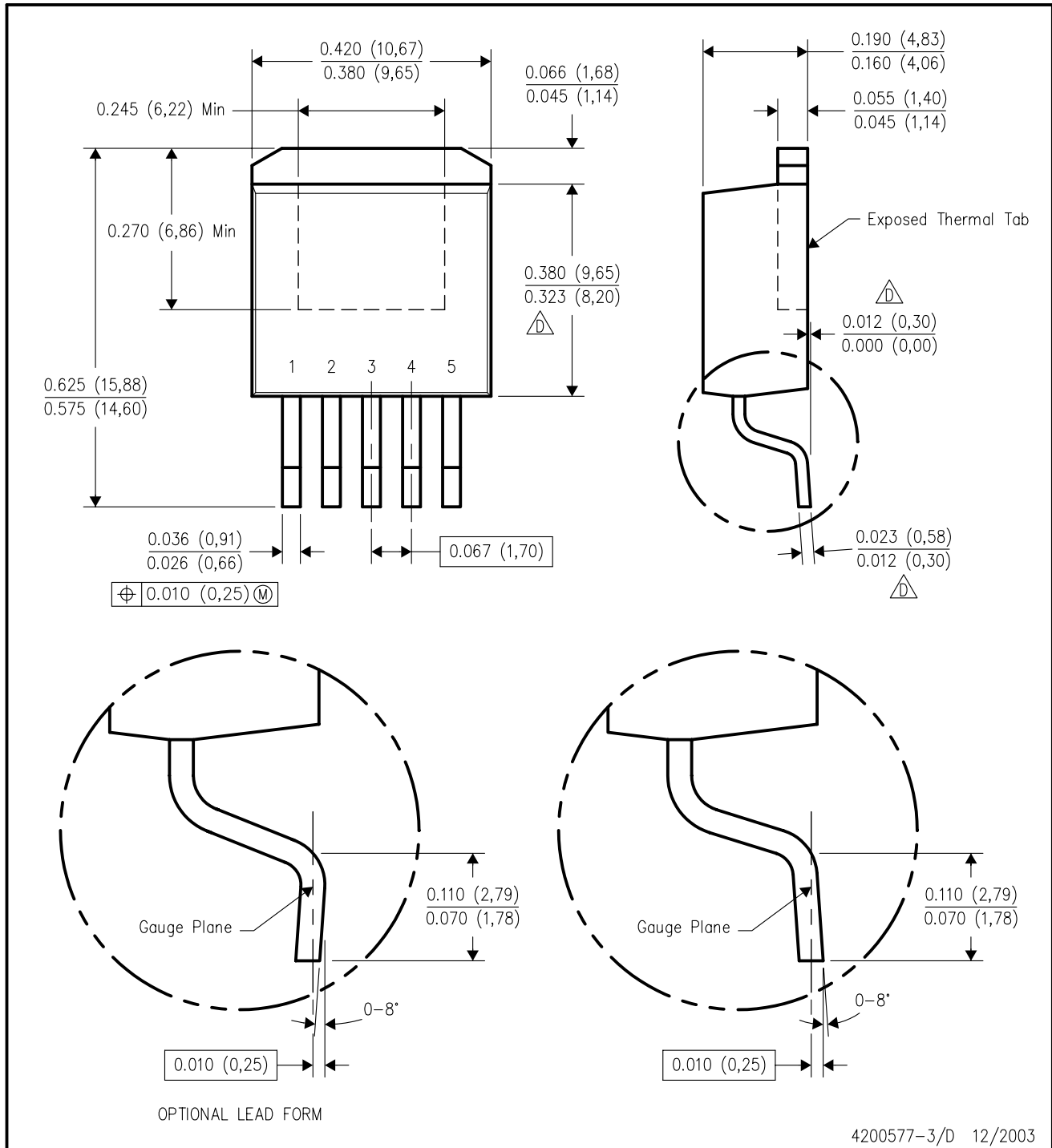

- NOTES:
- A. All linear dimensions are in inches (millimeters).
 - B. This drawing is subject to change without notice.
 - C. Dimensions do not include mold protrusions, not to exceed 0.006 (0,15).
- ⚠ Falls within JEDEC TO-263 variation BA, except minimum lead thickness, maximum seating height, and minimum body length.

IMPORTANT NOTICE

Texas Instruments Incorporated and its subsidiaries (TI) reserve the right to make corrections, modifications, enhancements, improvements, and other changes to its products and services at any time and to discontinue any product or service without notice. Customers should obtain the latest relevant information before placing orders and should verify that such information is current and complete. All products are sold subject to TI's terms and conditions of sale supplied at the time of order acknowledgment.

TI warrants performance of its hardware products to the specifications applicable at the time of sale in accordance with TI's standard warranty. Testing and other quality control techniques are used to the extent TI deems necessary to support this warranty. Except where mandated by government requirements, testing of all parameters of each product is not necessarily performed.

TI assumes no liability for applications assistance or customer product design. Customers are responsible for their products and applications using TI components. To minimize the risks associated with customer products and applications, customers should provide adequate design and operating safeguards.

TI does not warrant or represent that any license, either express or implied, is granted under any TI patent right, copyright, mask work right, or other TI intellectual property right relating to any combination, machine, or process in which TI products or services are used. Information published by TI regarding third-party products or services does not constitute a license from TI to use such products or services or a warranty or endorsement thereof. Use of such information may require a license from a third party under the patents or other intellectual property of the third party, or a license from TI under the patents or other intellectual property of TI.

Reproduction of information in TI data books or data sheets is permissible only if reproduction is without alteration and is accompanied by all associated warranties, conditions, limitations, and notices. Reproduction of this information with alteration is an unfair and deceptive business practice. TI is not responsible or liable for such altered documentation.

Resale of TI products or services with statements different from or beyond the parameters stated by TI for that product or service voids all express and any implied warranties for the associated TI product or service and is an unfair and deceptive business practice. TI is not responsible or liable for any such statements.

Following are URLs where you can obtain information on other Texas Instruments products and application solutions:

Products		Applications	
Amplifiers	amplifier.ti.com	Audio	www.ti.com/audio
Data Converters	dataconverter.ti.com	Automotive	www.ti.com/automotive
DSP	dsp.ti.com	Broadband	www.ti.com/broadband
Interface	interface.ti.com	Digital Control	www.ti.com/digitalcontrol
Logic	logic.ti.com	Military	www.ti.com/military
Power Mgmt	power.ti.com	Optical Networking	www.ti.com/opticalnetwork
Microcontrollers	microcontroller.ti.com	Security	www.ti.com/security
		Telephony	www.ti.com/telephony
		Video & Imaging	www.ti.com/video
		Wireless	www.ti.com/wireless

Mailing Address: Texas Instruments
Post Office Box 655303 Dallas, Texas 75265