

μA725 Instrumentation Operational Amplifier

Linear Division Operational Amplifiers

Description

The μA725 is a monolithic instrumentation operational amplifier constructed using the Fairchild Planar Epitaxial process. It is intended for precise, low level signal amplification applications where low noise, low drift, and accurate closed loop gain are required. The offset null capability, low power consumption, very high voltage gain as well as wide power supply voltage range provide superior performance for a wide range of instrumentation applications. The μA725 is lead compatible with the popular μA741 operational amplifier.

- **Low Input Noise Current** — 0.15 pA/√Hz
At 1.0 kHz Typically
- **High Open Loop Gain** — 3,000,000 Typically
- **Low Input Offset Current** — 2.0 nA Typically
- **Low Input Voltage Drift** — 0.6 μV/°C Typically
- **High Common Mode Rejection** — 120 dB
- **High Input Voltage Range** — ±14 V Typically
- **Wide Power Supply Range** — ±3.0 V To ±22 V
- **Offset Null Capability**

Absolute Maximum Ratings

Storage Temperature Range	
Metal Can	-65°C to +175°C
Molded DIP	-65°C to +150°C
Operating Temperature Range	
Extended (μA725AM, μA725M)	-55°C to +125°C
Commercial (μA725EC, μA725C)	0°C to +70°C
Lead Temperature	
Metal Can (soldering, 60 s)	300°C
Molded DIP (soldering, 10 s)	265°C
Internal Power Dissipation ^{1, 2}	
8L-Metal Can	1.00 W
8L-Molded DIP	0.93 W
Supply Voltage	±22 V
Differential Input Voltage	±5.0 V
Input Voltage ³	±22 V
Voltage Between Offset Null and V+	±0.5 V

Notes

1. T_{J Max} = 150°C for the Molded DIP, and 175°C for the Metal Can.
2. Ratings apply to ambient temperature at 25°C. Above this temperature, derate the 8L-Metal Can at 6.7 mW/°C, and the 8L-Molded DIP at 7.5 mW/°C.
3. For supply voltages less than ±22 V, the absolute maximum input voltage is equal to the supply voltage.

Connection Diagram 8-Lead Metal Package (Top View)

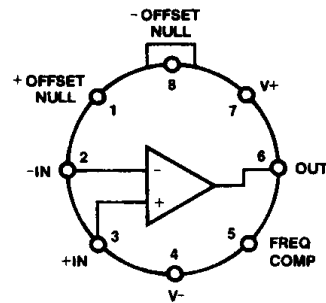

CD00581F

Lead 4 connected to case.

Order Information

Device Code	Package Code	Package Description
μA725HM	5W	Metal
μA725HC	5W	Metal
μA725AHM	5W	Metal
μA725EHC	5W	Metal

Connection Diagram 8-Lead DIP (Top View)

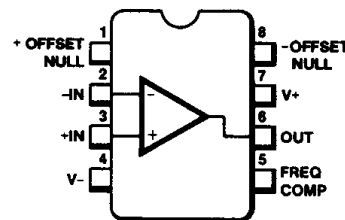

CD00601F

Order Information

Device Code	Package Code	Package Description
μA725TC	9T	Molded DIP

Equivalent Circuit

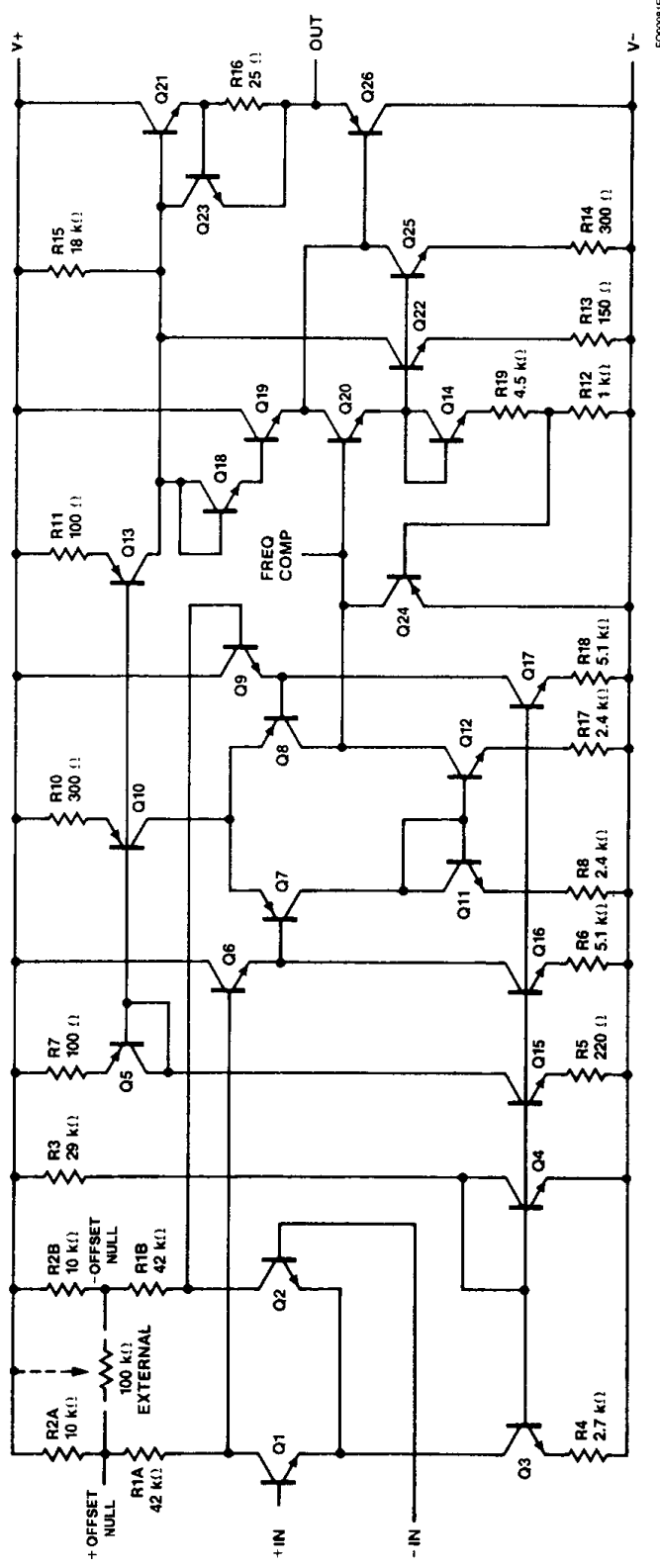

μA725

μA725A/E and μA725

Electrical Characteristics $T_A = 25^\circ\text{C}$, $V_{CC} = \pm 15\text{ V}$, unless otherwise specified.

Symbol	Characteristic	Condition	μA725A/E			μA725			Unit
			Min	Typ	Max	Min	Typ	Max	
V_{IO}	Input Offset Voltage (Without external trim)	$R_S \leq 10\text{ k}\Omega$			0.5		0.5	1.0	mV
I_{IO}	Input Offset Current				5.0		2.0	20	nA
I_{IB}	Input Bias Current				75		42	100	nA
Z_I	Input Impedance			1.5			1.5		MΩ
P_c	Power Consumption	μA725A/μA725		80	120		80	120	mW
		μA725E			150				
		$V_{CC} = \pm 3.0\text{ V}$			6.0				
CMR	Common Mode Rejection	$R_S \leq 10\text{ k}\Omega$	120	130		110	120		dB
V_{IR}	Input Voltage Range		± 13.5	± 14		± 13.5	± 14		V
PSRR	Power Supply Rejection Ratio	$R_S \leq 10\text{ k}\Omega$		2.0	5.0		2.0	10	μV/V
A_{VS}	Large Signal Voltage Gain	$R_L \geq 2.0\text{ k}\Omega$, $V_O = \pm 10\text{ V}$	1000	3000		1000	3000		V/mV
V_{OP}	Output Voltage Swing	$R_L = 10\text{ k}\Omega$	± 12.5			± 12	± 13.5		V
		$R_L = 2.0\text{ k}\Omega$	± 10			± 10	± 13.5		V
e_n	Input Noise Voltage	$f_o = 10\text{ Hz}$		15	15		15		nV/√Hz
		$f_o = 100\text{ Hz}$		9.0	12		9.0		
		$f_o = 1.0\text{ kHz}$		8.0	12		8.0		
i_n	Input Noise Current	$f_o = 10\text{ Hz}$		1.0	1.2		1.0		pA/√Hz
		$f_o = 100\text{ Hz}$		0.3	0.6		0.3		
		$f_o = 1.0\text{ kHz}$		0.15	0.25		0.15		

The following specifications apply over the range of $0^\circ\text{C} \leq T_A \leq +70^\circ\text{C}$ for μA725E, $-55^\circ\text{C} \leq T_A \leq +125^\circ\text{C}$ for μA725A and μA725.

V_{IO}	Input Offset Voltage (Without external trim)	$R_S \leq 10\text{ k}\Omega$			0.75			1.5	mV
$\Delta V_{IO}/\Delta T$	Input Offset Voltage Temperature Sensitivity (Without external trim)	$R_S = 50\ \Omega$		2.0	2.0		2.0	5.0	μV/°C
$\Delta V_{IO}/\Delta T$	Input Offset Voltage Temperature Sensitivity (With external trim)	$R_S = 50\ \Omega$		0.6			0.6		μV/°C
I_{IO}	Input Offset Current	$T_A = T_{A\text{ Max}}$			4.0		1.2	20	nA
		$T_A = T_{A\text{ Min}}$		5.0	18		7.5	40	

μA725

μA725A/E and μA725 (Cont.)

Electrical Characteristics $V_{CC} = \pm 15 \text{ V}$, $0^\circ\text{C} \leq T_A \leq +70^\circ\text{C}$ for μA725E, $-55^\circ\text{C} \leq T_A \leq +125^\circ\text{C}$ for μA725A and μA725.

Symbol	Characteristic	Condition	μA725A/E			μA725			Unit
			Min	Typ	Max	Min	Typ	Max	
$\Delta I_{IO}/\Delta T$	Input Offset Current Temperature Sensitivity			35	90		35		pA/°C
I_{IB}	Input Bias Current	$T_A = T_{A \text{ Max}}$			70		20	100	nA
		$T_A = T_{A \text{ Min}}$			180		80	200	nA
CMR	Common Mode Rejection	$R_S \leq 10 \text{ k}\Omega$	110			100			dB
PSRR	Power Supply Rejection Ratio	$R_S \leq 10 \text{ k}\Omega$			8.0			20	μV/V
A_{VS}	Large Signal Voltage Gain	$R_L \geq 2.0 \text{ k}\Omega$, $T_A = T_{A \text{ Max}}$	1000			1000			V/mV
		$R_L \geq 2.0 \text{ k}\Omega$, $T_A = T_{A \text{ Min}}$	500			250			V/mV
V_{OP}	Output Voltage Swing	$R_L = 2.0 \text{ k}\Omega$	± 10			± 10			V

μA725C

Electrical Characteristics $T_A = 25^\circ\text{C}$, $V_{CC} = \pm 15 \text{ V}$, unless otherwise specified.

Symbol	Characteristic	Condition	Min	Typ	Max	Unit
V_{IO}	Input Offset Voltage (Without external trim)	$R_S \leq 10 \text{ k}\Omega$		0.5	2.5	mV
I_{IO}	Input Offset Current			2.0	35	nA
I_{IB}	Input Bias Current			42	125	nA
e_n	Input Noise Voltage	$f_o = 10 \text{ Hz}$		15		nV/√Hz
		$f_o = 100 \text{ Hz}$		9.0		
		$f_o = 1.0 \text{ kHz}$		8.0		
i_n	Input Noise Current	$f_o = 10 \text{ Hz}$		1.0		pA/√Hz
		$f_o = 100 \text{ Hz}$		0.3		
		$f_o = 1.0 \text{ kHz}$		0.15		
Z_I	Input Impedance			1.5		MΩ
V_{IR}	Input Voltage Range		± 13.5	± 14		V
A_{VS}	Large Signal Voltage Gain	$R_L \geq 2.0 \text{ k}\Omega$, $V_O = \pm 10 \text{ V}$	250	3000		V/mV
CMR	Common Mode Rejection	$R_S \leq 10 \text{ k}\Omega$	94	120		dB
PSRR	Power Supply Rejection Ratio	$R_S \leq 10 \text{ k}\Omega$		2.0	35	μV/V
V_{OP}	Output Voltage Swing	$R_L = 10 \text{ k}\Omega$	± 12	± 13.5		V
		$R_L = 2.0 \text{ k}\Omega$	± 10	± 13.5		
P_c	Power Consumption			80	150	mW

μA725

μA725C (Cont.)

Electrical Characteristics $0^{\circ}\text{C} \leq T_A \leq +70^{\circ}\text{C}$, $V_{CC} = \pm 15\text{ V}$, unless otherwise specified.

Symbol	Characteristic	Condition	Min	Typ	Max	Unit
V_{IO}	Input Offset Voltage (Without external trim)	$R_S \leq 10\text{ k}\Omega$			3.5	mV
$\Delta V_{IO}/\Delta T$	Input Offset Voltage Temperature Sensitivity (Without external trim)	$R_S = 50\ \Omega$		2.0		$\mu\text{V}/^{\circ}\text{C}$
$\Delta V_{IO}/\Delta T$	Input Offset Voltage Temperature Sensitivity (With external trim)	$R_S = 50\ \Omega$		0.6		$\mu\text{V}/^{\circ}\text{C}$
I_{IO}	Input Offset Current	$T_A = T_{A\text{ Max}}$		1.2	35	nA
		$T_A = T_{A\text{ Min}}$		4.0	50	
$\Delta I_{IO}/\Delta T$	Input Offset Current Temperature Sensitivity			10		$\text{pA}/^{\circ}\text{C}$
I_{IB}	Input Bias Current	$T_A = T_{A\text{ Max}}$			125	nA
		$T_A = T_{A\text{ Min}}$			250	
A_{VS}	Large Signal Voltage Gain	$R_L \geq 2.0\text{ k}\Omega$	125			V/mV
CMR	Common Mode Rejection	$R_S \leq 10\text{ k}\Omega$		115		dB
PSRR	Power Supply Rejection Ratio	$R_S \leq 10\text{ k}\Omega$		20		$\mu\text{V}/\text{V}$
V_{OP}	Output Voltage Swing	$R_L = 2.0\text{ k}\Omega$	± 10			V

Typical Performance Curves

Voltage Gain vs Temperature For Supply Voltages For μ A725/A

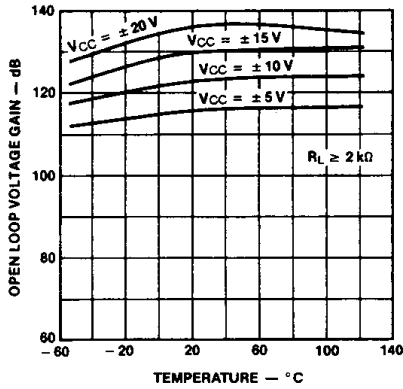

PC03460F

Change in Trimmed Input Offset Voltage vs Temperature For μ A725/A

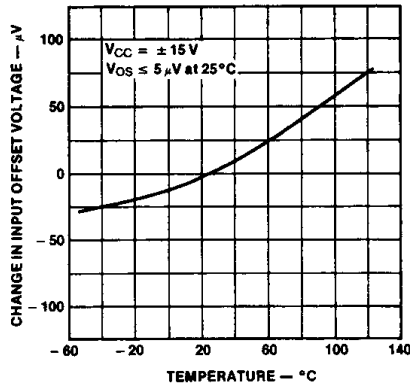

PC03460F

Untrimmed Input Offset Voltage vs Temperature For μ A725/A

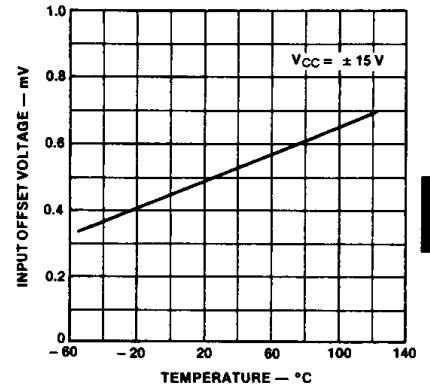

PC03440F

Voltage Gain vs Temperature for Supply Voltages For μ A725C/E

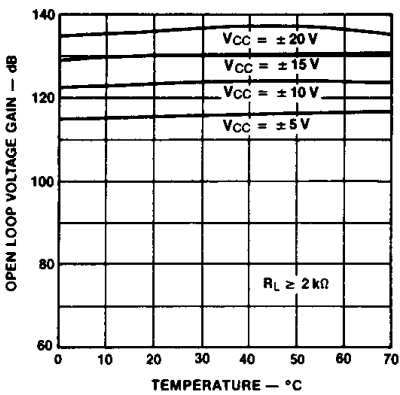

PC03420F

Trimmed Input Offset Voltage vs Temperature For μ A725C/E

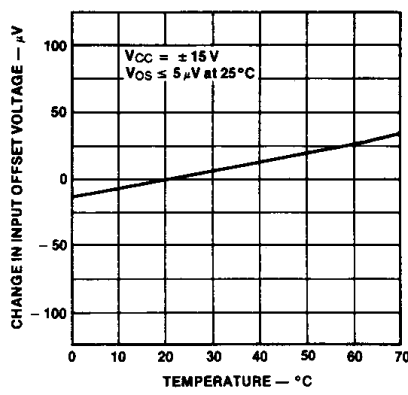

PC03460F

Untrimmed Input Offset Voltage vs Temperature For μ A725C/E

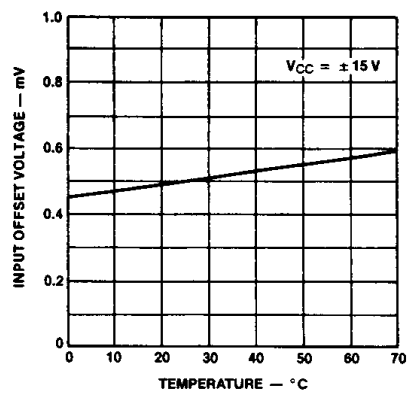

PC03470F

Input Offset Current vs Temperature For μ A725/A

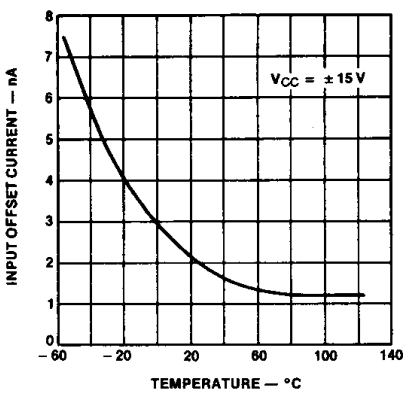

PC03480F

Input Offset Current vs Temperature For μ A725C/E

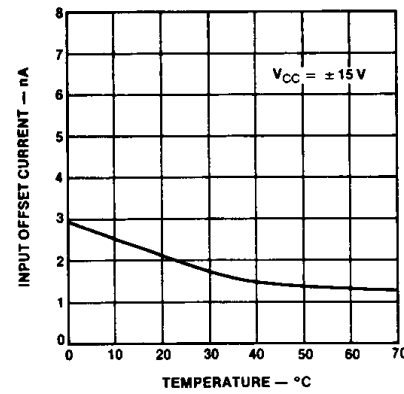

PC03490F

Input Bias Current vs Temperature For μ A725/A

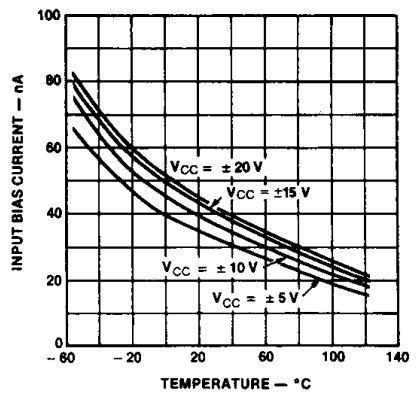

PC03500F

7

Typical Performance Curves for all Types (Cont.)

Input Bias Current vs Temperature μA725C/E

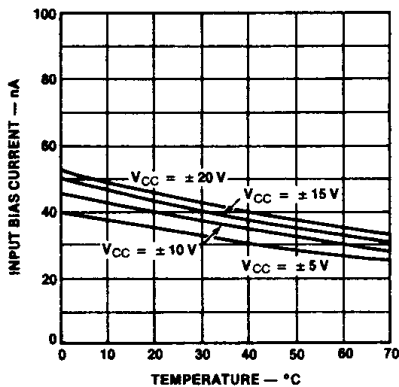

PC03510F

Common Mode Rejection Ratio vs Temperature

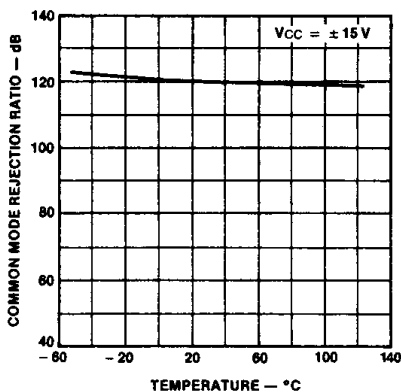

PC03520F

Power Supply Rejection Ratio vs Temperature

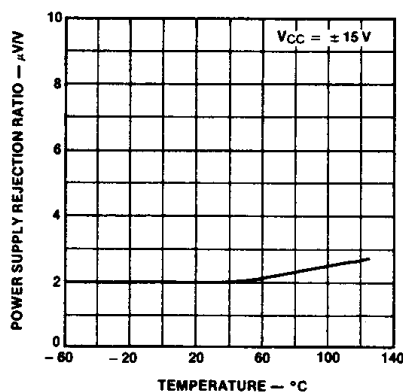

PC03530F

Output Voltage Swing vs Temperature

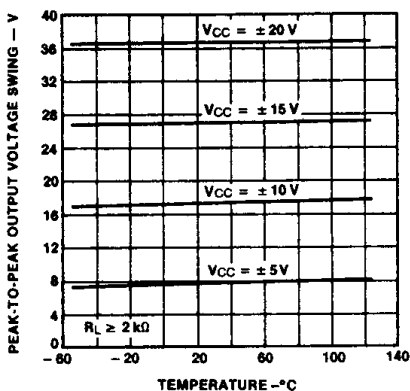

PC03540F

Common Mode Rejection Ratio vs Supply Voltage

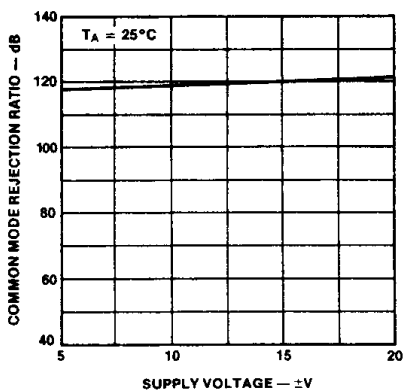

PC03550F

DC Closed Loop Voltage Gain Error vs Source Resistance

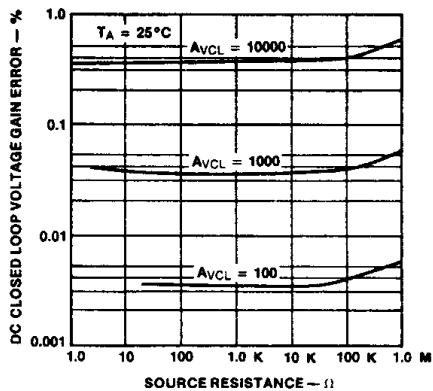

PC03561F

Common Mode Input Voltage Range vs Supply Voltage

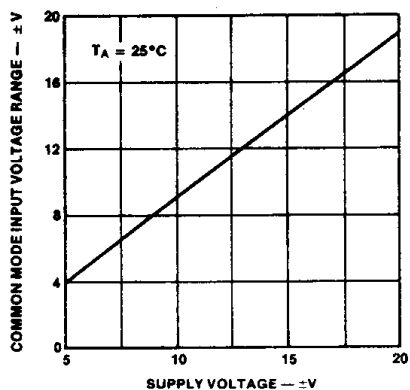

PC03570F

Input Offset Voltage Drift vs Time

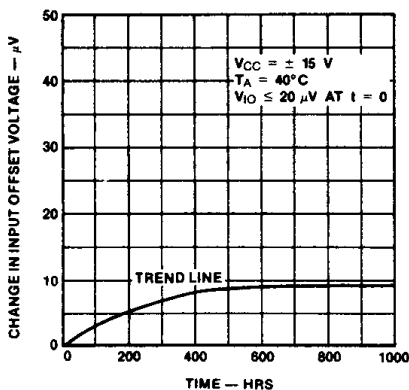

PC03580F

Stabilization Time of Input Offset Voltage From Power Turn-On

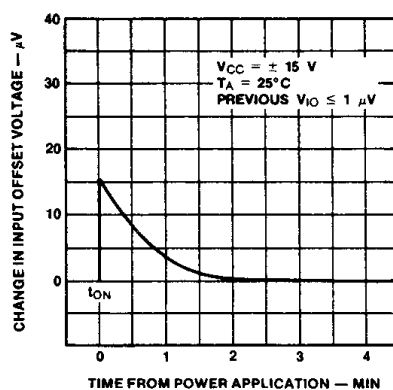

PC03590F

Typical Performance Curves for all Types (Cont.)

Change in Input Offset Voltage Due to Thermal Shock vs Time

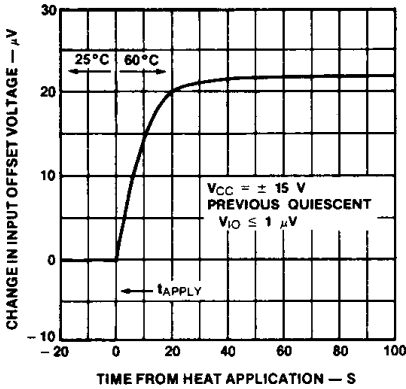

PC03600F

Input Noise Voltage vs Frequency

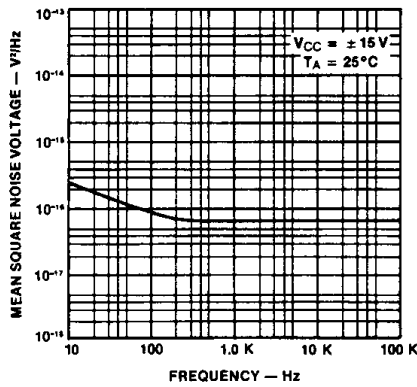

PC03611F

Input Noise Current vs Frequency

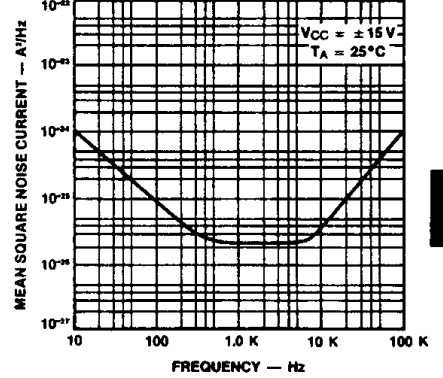

PC03621F

Broadband Noise for Various Bandwidths

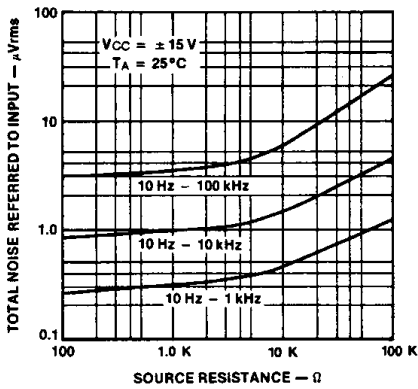

PC03631F

Narrow Band Spot Noise Figure Contours

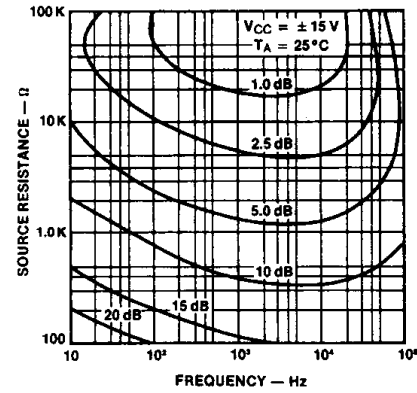

PC03641F

Noise Figure vs Source Resistance

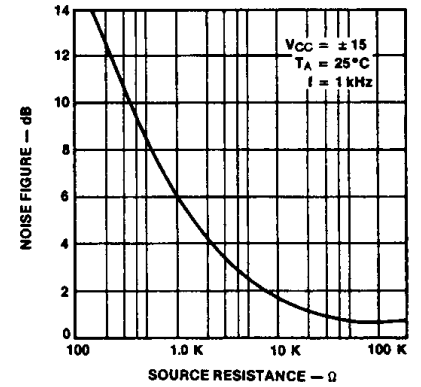

PC03651F

Equivalent Input Noise Voltage Due to External Common Mode Noise vs Frequency

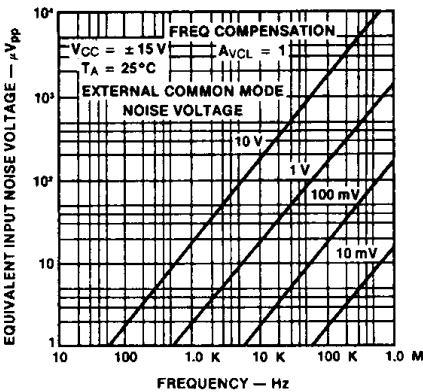

PC03661F

Equivalent Input Ripple Voltage Due to Power Supply Ripple vs Frequency

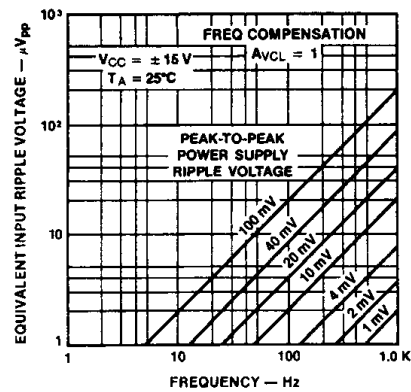

PC03671F

7

Typical Performance Curves for all Types (Cont.)

Power Consumption vs Temperature

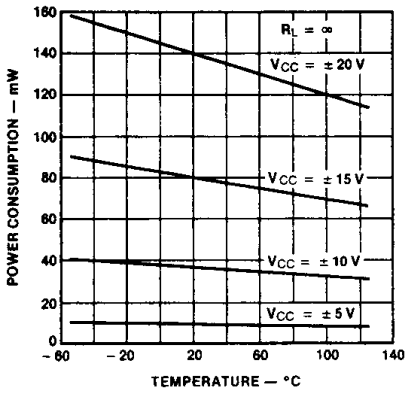

PC0369F

Open Loop Frequency Response For Values of Compensation

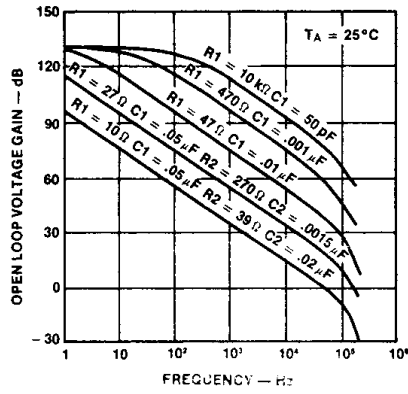

PC0370F

Values for Suggested Compensation Networks vs Various Closed Loop Voltage Gains

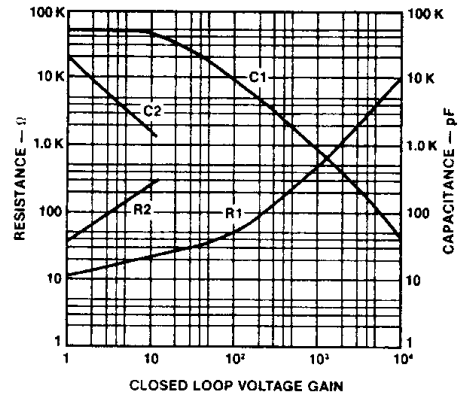

PC0371F

Frequency Response for Various Closed Loop Gains

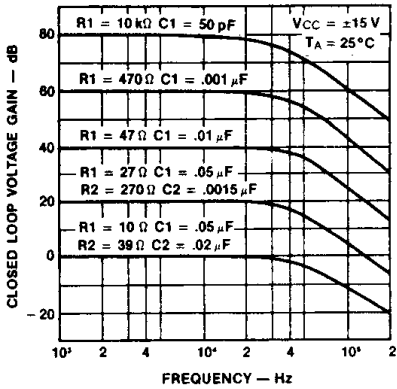

PC0372F

Output Voltage Swing vs Frequency

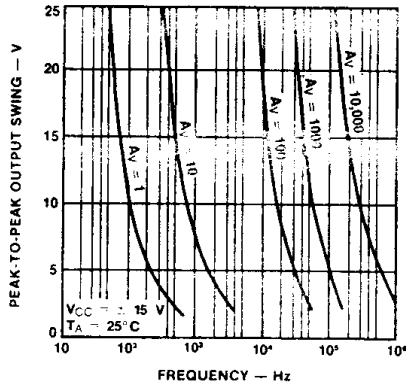

PC0373F

Slew Rate vs Closed Loop Gain

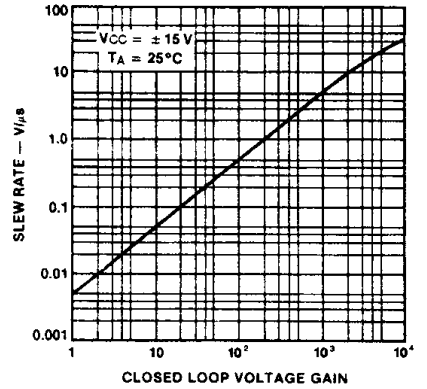

PC0374F

Compensation Component Values

A _v	R ₁ (Ω)	C ₁ (μF)	R ₂ (Ω)	C ₂ (μF)
10,000	10 k	50 pF	—	—
1,000	470	.001	—	—
100	47	.01	—	—
10	27	.05	270	.0015
1	10	.05	39	.02

Voltage Offset Null Circuit

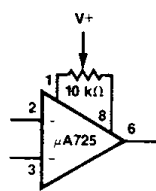

CR01140F

Frequency Compensation Circuit

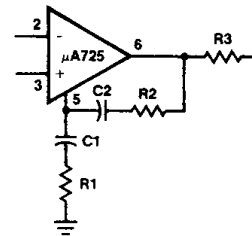

CR01150F

Use R₃ = 51Ω when the amplifier is operated with capacitive load.

Transient Response Test Circuit

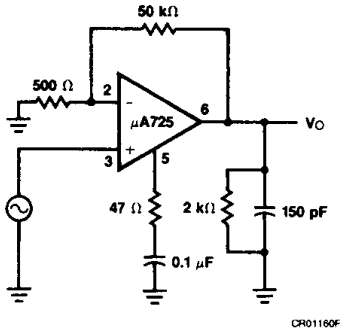

CR01160F

Transient Response

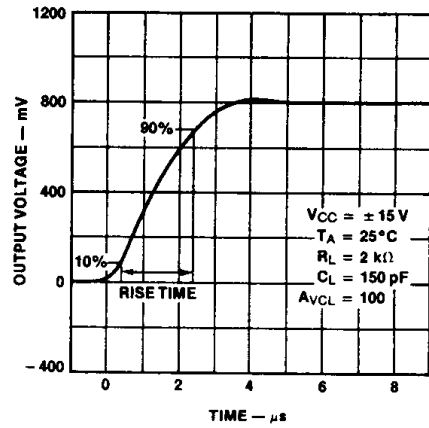

PC03750F

7

Typical Applications

Precision Amplifier $A_{VCL} = 1000$

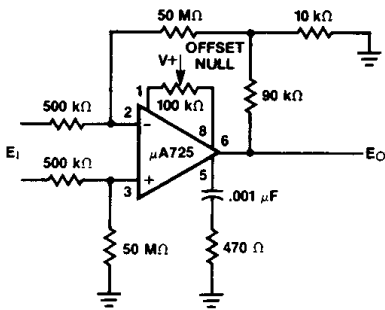

AF00520F

Characteristics

- $A_V = 1000 = 60 \text{ dB}$
- DC Gain Error = 0.05%
- Bandwidth = 1 kHz for -0.05% error
- Diff. Input Res. = 1 MΩ
- Typical amplifying capability
- $e_n = 10 \mu\text{V}$ on $V_{CM} = 1.0 \text{ V}$
- Caution: Minimize Stray Capacitance

Active Filter — Band Pass With 60 dB Gain

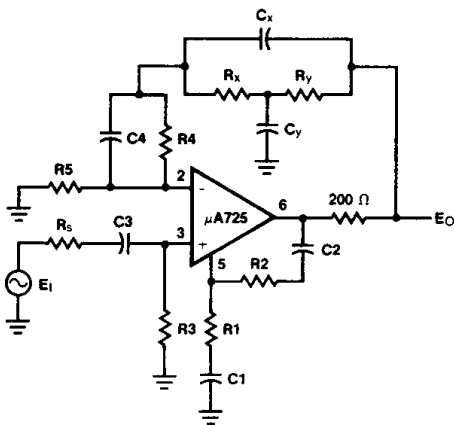

AF00530F

Active Filter Frequency Response

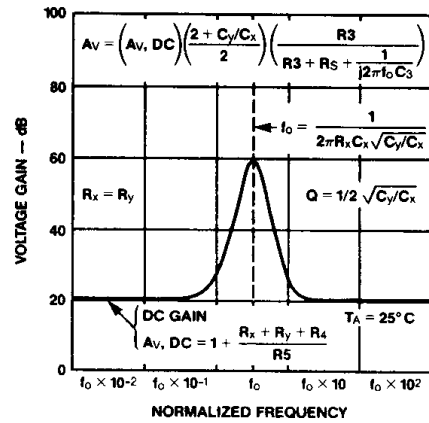

PC03760F

Lead numbers are shown for metal package only.

Typical Applications (Cont.)

Instrumentation Amplifier With High Common Mode Rejection (Note 1)

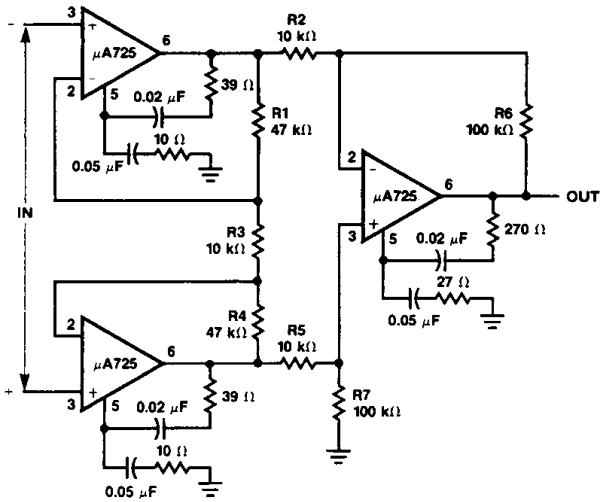

AF00571F

$$\frac{R1}{R6} = \frac{R3}{R4} \text{ for best CMRR}$$

$$R3 = R4$$

$$R1 = R6 = 10 R3$$

$$\text{Gain} = \frac{R6}{R7}$$

Note

1. Lead numbers are shown for metal package only.