

Power management (dual transistors)

EMF23/UMF23N

2SA1774 and DTC114E are housed independently in a EMT6 or UMT6 package.

●Application

Power management circuit

●Features

- 1) Power switching circuit in a single package.
- 2) Mounting cost and area can be cut in half.

●Structure

Silicon epitaxial planar transistor

●Equivalent circuits

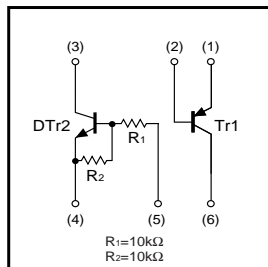

●External dimensions (Units : mm)

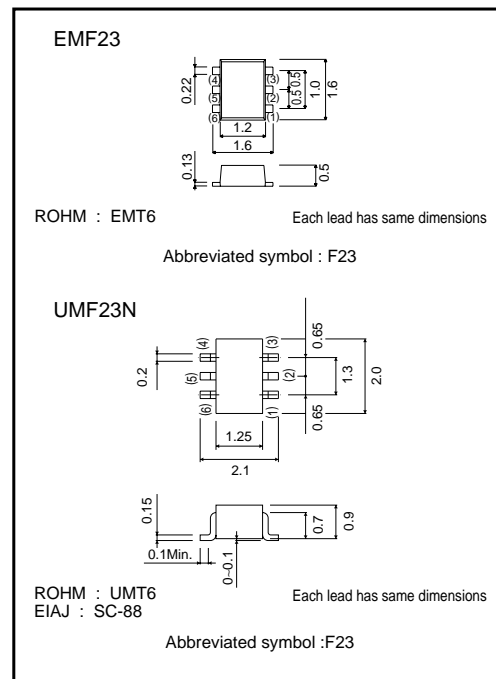

●Package, marking, and packaging specifications

| Type | EMF23 | UMF23N |
|------------------------------|-------|--------|
| Package | EMT6 | UMT6 |
| Marking | F23 | F23 |
| Code | T2R | TR |
| Basic ordering unit (pieces) | 8000 | 3000 |

Transistors

●Absolute maximum ratings (Ta=25°C)

Tr1

| Parameter | Symbol | Limits | Unit |
|-----------------------------|------------------|-------------|------|
| Collector-base voltage | V _{CB0} | -60 | V |
| Collector-emitter voltage | V _{CEO} | -50 | V |
| Emitter-base voltage | V _{EBO} | -6 | V |
| Collector current | I _c | -150 | mA |
| Collector power dissipation | P _c | 150 (TOTAL) | mW * |
| Junction temperature | T _j | 150 | °C |
| Storage temperature | T _{stg} | -55 to +150 | °C |

* 120mW per element must not be exceeded.

DTr2

| Parameter | Symbol | Limits | Unit |
|------------------------------|------------------|-------------|-------|
| Supply voltage | V _{CC} | 50 | V |
| Input voltage | V _{IN} | -10~+40 | V |
| Collector current | I _c | 100 | mA *1 |
| Output current | I _o | 50 | mA |
| Power dissipation | P _c | 150(TOTAL) | mW *2 |
| Junction temperature | T _j | 150 | °C |
| Range of storage temperature | T _{stg} | -55 to +150 | °C |

*1 Characteristics of built-in transistor.

*2 120mW per element must not be exceeded.
Each terminal mounted on a recommended land.

●Electrical characteristics (Ta=25°C)

Tr1

| Parameter | Symbol | Min. | Typ. | Max. | Unit | Conditions |
|--------------------------------------|----------------------|------|------|------|------|--|
| Collector-base breakdown voltage | BV _{CB0} | -60 | - | - | V | I _c =-50μA |
| Collector-emitter breakdown voltage | BV _{CEO} | -50 | - | - | V | I _c =-1mA |
| Emitter-base breakdown voltage | BV _{EBO} | -6 | - | - | V | I _E =-50μA |
| Collector cutoff current | I _{CB0} | - | - | -0.1 | μA | V _{CB} =-60V |
| Emitter cutoff current | I _{EBO} | - | - | -0.1 | μA | V _{EB} =-6V |
| Collector-emitter saturation voltage | V _{CE(sat)} | - | - | -0.5 | V | I _c /I _B =-50mA/-5mA |
| DC current transfer ratio | h _{FE} | 180 | - | 390 | - | V _{CE} =-6V, I _c =-1mA |
| Transition frequency | f _T | - | 140 | - | MHz | V _{CE} =-12V, I _E =2mA, f=100MHz |
| Output capacitance | C _{ob} | - | 4 | 5 | pF | V _{CB} =-12V, I _E =0A, f=1MHz |

DTr2

| Parameter | Symbol | Min. | Typ. | Max. | Unit | Conditions |
|----------------------|--------------------------------|------|------|------|------|--|
| Input voltage | V _{I(off)} | - | - | 0.5 | V | V _{CC} =5V, I _o =100μA |
| | V _{I(on)} | 3 | - | - | | V _o =0.3V, I _o =10mA |
| Output voltage | V _{O(on)} | - | 0.1 | 0.3 | V | I _o /I _i =10mA/0.5mA |
| Input current | I _i | - | - | 0.88 | mA | V _i =5V |
| Output current | I _{o(off)} | - | - | 0.5 | μA | V _{CC} =50V, V _i =0V |
| DC current gain | G _i | 30 | - | - | - | V _o =5V, I _o =5mA |
| Input resistance | R ₁ | 7 | 10 | 13 | kΩ | - |
| Resistance ratio | R ₂ /R ₁ | 0.8 | 1 | 1.2 | - | - |
| Transition frequency | f _T | - | 250 | - | MHz | V _{CE} =10V, I _E =-5mA, f=100MHz * |

* Transition frequency of the device

Transistors

●Electrical characteristic curves

Tr1

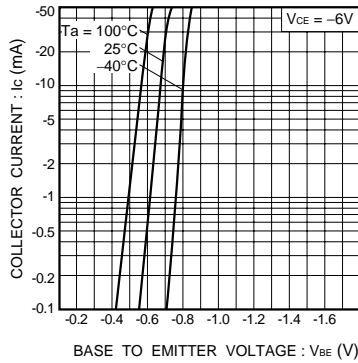

Fig.1 Grounded emitter propagation characteristics

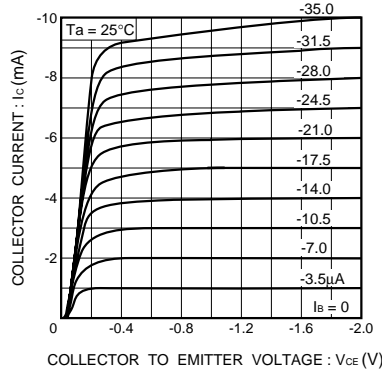

Fig.2 Grounded emitter output characteristics (I)

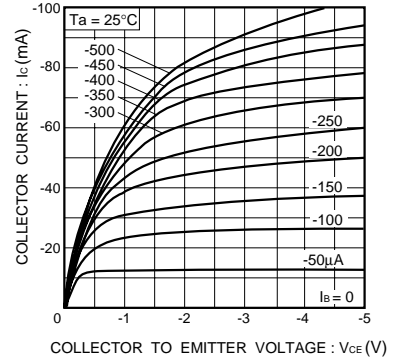

Fig.3 Grounded emitter output characteristics (II)

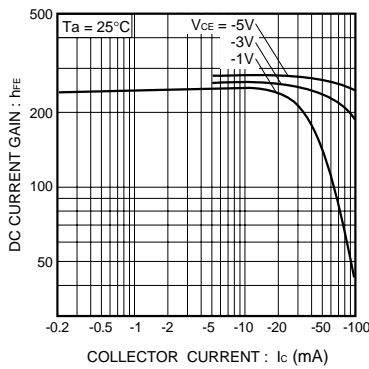

Fig.4 DC current gain vs. collector current (I)

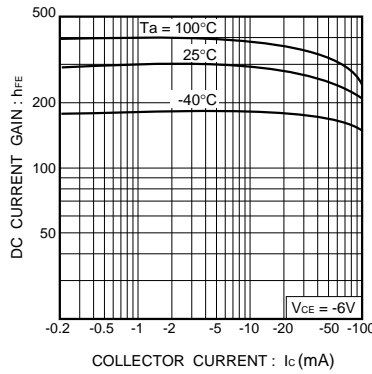

Fig.5 DC current gain vs. collector current (II)

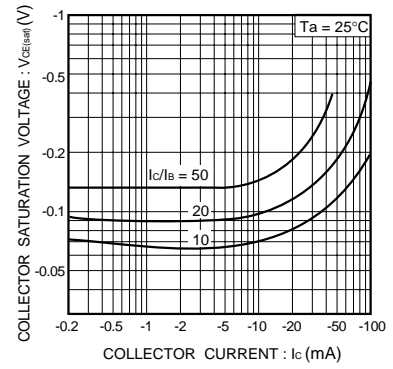

Fig.6 Collector-emitter saturation voltage vs. collector current (I)

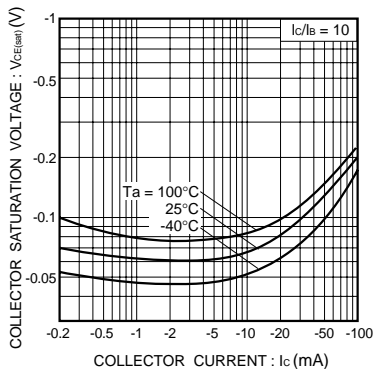

Fig.7 Collector-emitter saturation voltage vs. collector current (II)

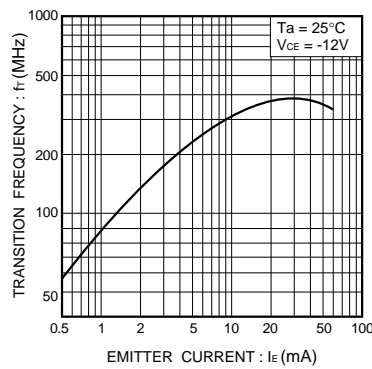

Fig.8 Gain bandwidth product vs. emitter current

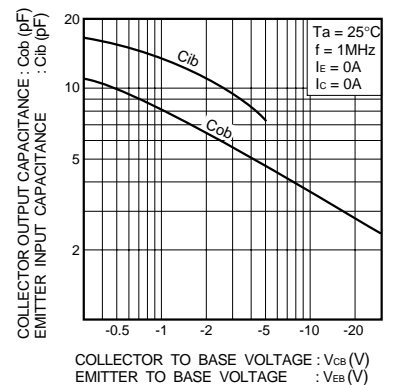

Fig.9 Collector output capacitance vs. collector-base voltage
Emitter input capacitance vs. emitter-base voltage

Transistors

DTr2

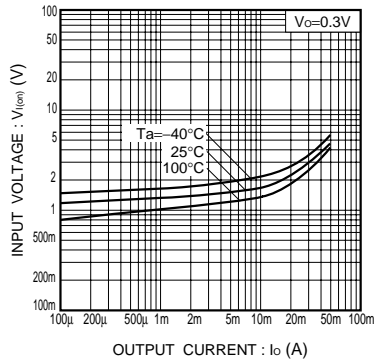

Fig.1 Input voltage vs. output current (ON characteristics)

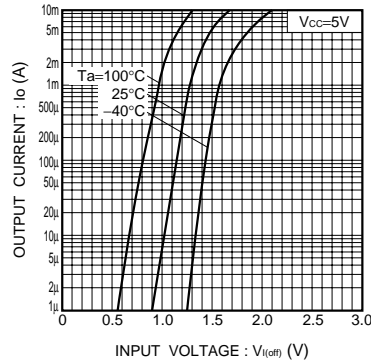

Fig.2 Output current vs. input voltage (OFF characteristics)

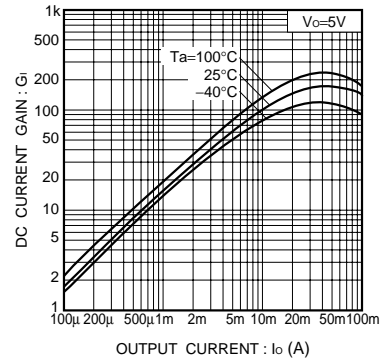

Fig.3 DC current gain vs. output current

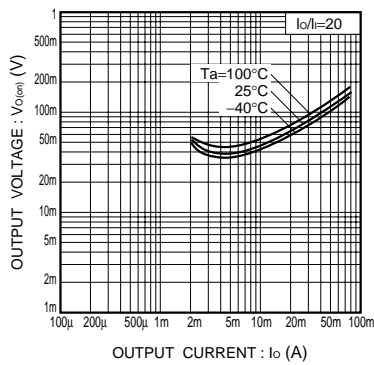

Fig.4 Output voltage vs. output current

Notes

- No technical content pages of this document may be reproduced in any form or transmitted by any means without prior permission of ROHM CO.,LTD.
- The contents described herein are subject to change without notice. The specifications for the product described in this document are for reference only. Upon actual use, therefore, please request that specifications to be separately delivered.
- Application circuit diagrams and circuit constants contained herein are shown as examples of standard use and operation. Please pay careful attention to the peripheral conditions when designing circuits and deciding upon circuit constants in the set.
- Any data, including, but not limited to application circuit diagrams information, described herein are intended only as illustrations of such devices and not as the specifications for such devices. ROHM CO.,LTD. disclaims any warranty that any use of such devices shall be free from infringement of any third party's intellectual property rights or other proprietary rights, and further, assumes no liability of whatsoever nature in the event of any such infringement, or arising from or connected with or related to the use of such devices.
- Upon the sale of any such devices, other than for buyer's right to use such devices itself, resell or otherwise dispose of the same, no express or implied right or license to practice or commercially exploit any intellectual property rights or other proprietary rights owned or controlled by
- ROHM CO., LTD. is granted to any such buyer.
- Products listed in this document use silicon as a basic material.
Products listed in this document are no antiradiation design.

The products listed in this document are designed to be used with ordinary electronic equipment or devices (such as audio visual equipment, office-automation equipment, communications devices, electrical appliances and electronic toys).

Should you intend to use these products with equipment or devices which require an extremely high level of reliability and the malfunction of which would directly endanger human life (such as medical instruments, transportation equipment, aerospace machinery, nuclear-reactor controllers, fuel controllers and other safety devices), please be sure to consult with our sales representative in advance.

About Export Control Order in Japan

Products described herein are the objects of controlled goods in Annex 1 (Item 16) of Export Trade Control Order in Japan.

In case of export from Japan, please confirm if it applies to "objective" criteria or an "informed" (by MITI clause) on the basis of "catch all controls for Non-Proliferation of Weapons of Mass Destruction.