



UP1868

PNP SILICON TRANSISTOR

LOW SATURATION VOLTAGE PNP POWER TRANSISTOR

■ FEATURES

- * Low saturation voltage with equivalent on-resistance be $R_{CE(SAT)}$ about 40mΩ at 5A)
- * High gain that can be replace parts for power MOSFET.

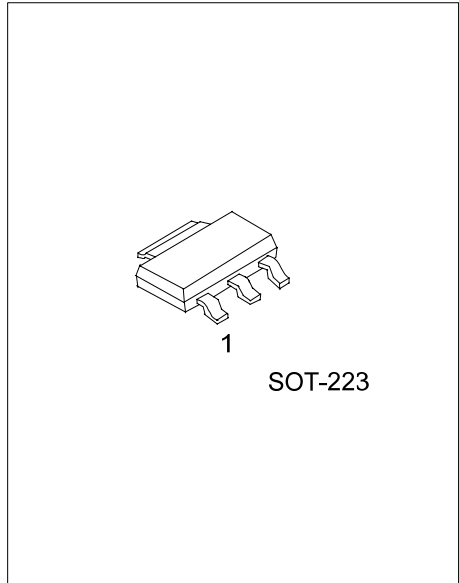

*Pb-free plating product number: UP1868L

■ ORDERING INFORMATION

Order Number		Package	Pin Assignment			Packing
Normal	Lead Free Plating		1	2	3	
UP1868-AA3-F-R	UP1868L-AA3-F-R	SOT-223	B	C	E	Tape Reel

<p>UP1868L-AA3-F-R</p> <ul style="list-style-type: none"> (1)Packing Type (2)Pin Assignment (3)Package Type (4)Lead Plating 	<ul style="list-style-type: none"> (1) R: Tape Reel (2) refer to Pin Assignment (3) AA3: SOT-223 (4) L: Lead Free Plating, Blank: Pb/Sn
---	---

■ ABSOLUTE MAXIMUM RATINGS (Ta=25°C)

PARAMETER	SYMBOL	RATINGS	UNIT
Collector-Base Voltage	V_{CBO}	-15	V
Collector-Emitter Voltage	V_{CEO}	-12	V
Emitter-Base Voltage	V_{EBO}	-6	V
Peak Pulse Current	$I_{C(PEAK)}$	-20	A
Continuous Collector Current	I_C	-6	A
Power Dissipation	P_C	3	W
Junction Temperature	T_J	+150	°C
Storage Temperature	T_{STG}	-40 ~ +150	°C

Note Absolute maximum ratings are those values beyond which the device could be permanently damaged. Absolute maximum ratings are stress ratings only and functional device operation is not implied.

■ ELECTRICAL CHARACTERISTICS (at Ta = 25°C unless otherwise specified)

PARAMETER	SYMBOL	TEST CONDITIONS	MIN	TYP	MAX	UNIT
Breakdown Voltage (Note)	BV_{CBO}	$I_C=-100\mu A$	-15			V
	BV_{CEO}	$I_C=-10mA$	-12			V
	BV_{EBO}	$I_E=-100\mu A$	-6			V
Collector-Emitter Saturation Voltage (Note)	$V_{CE(SAT)}$	$I_C=-500mA, I_B=-5mA$		-55	-100	mV
		$I_C=-2A, I_B=-50mA$		-132	-160	mV
		$I_C=-6A, I_B=-250mA$			-440	mV
Base-Emitter Saturation Voltage	$V_{BE(SAT)}$	$I_C=-6A, I_B=-250mA$		-1050	-1200	mV
Base-Emitter Turn-On Voltage (Note)	$V_{BE(ON)}$	$V_{CE}=-1V, I_C=-6A$		-950	-1050	mV
Collector Cut-Off Current	I_{CBO}	$V_{CB}=-12V$			-10	nA
		$V_{CB}=-12V, T_a=100^\circ C$			-1.0	μA
Emitter Cut-Off Current	I_{EBO}	$V_{EB}=-6V$			-10	nA
DC Current Gain (Note)	h_{FE1}	$V_{CE}=-1V, I_C=-10mA$	300			
	h_{FE2}	$V_{CE}=-1V, I_C=-500mA$	300		1000	
	h_{FE3}	$V_{CE}=-1V, I_C=-5mA$	200			
	h_{FE4}	$V_{CE}=-1V, I_C=-10A$	150			
Current Gain Bandwidth Product	f_T	$V_{CE}=-10V, I_C=-100mA, f=50MHz$		80		MHz
Output Capacitance	C_{ob}	$V_{CB}=-20V, f=1MHz$		161		pF
Switching Times	t_{ON}	$I_C=-4A, I_{B1}=-400mA$		120		ns
	t_{OFF}	$I_{B2}=400mA, V_{CC}=-10V$		116		

Note: Pulse test: Pulse Width=300 μs , Duty Cycle $\leq 2\%$

TYPICAL CHARACTERISTICS

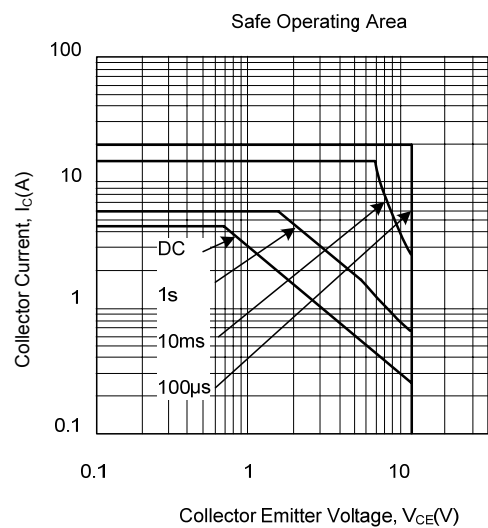
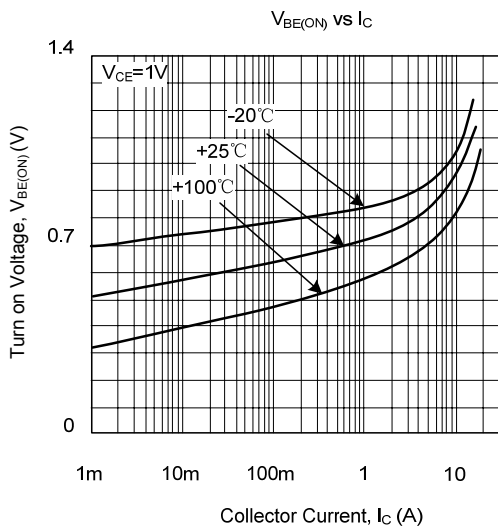
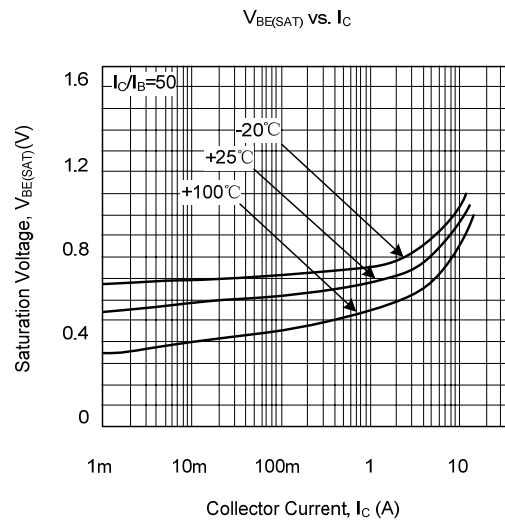
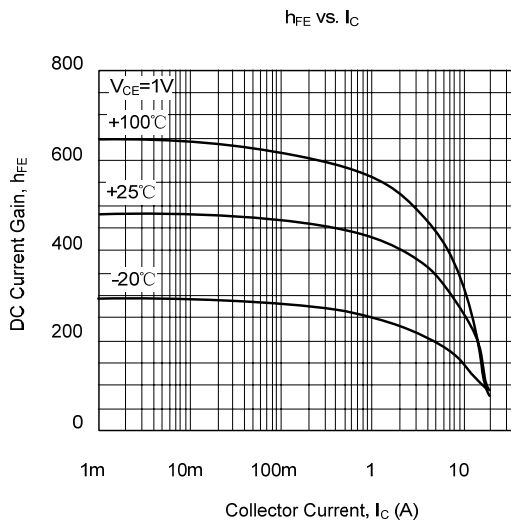
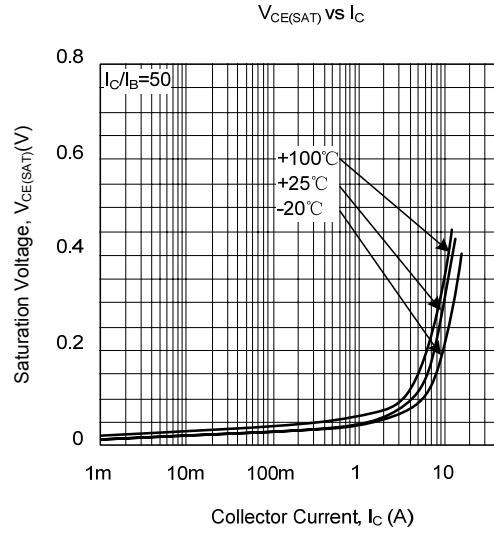
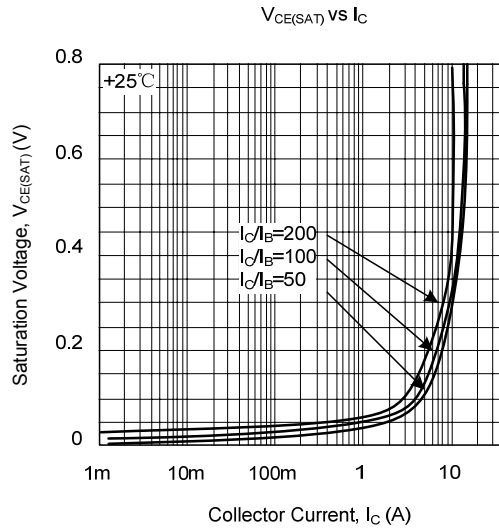

UTC assumes no responsibility for equipment failures that result from using products at values that exceed, even momentarily, rated values (such as maximum ratings, operating condition ranges, or other parameters) listed in products specifications of any and all UTC products described or contained herein. UTC products are not designed for use in life support appliances, devices or systems where malfunction of these products can be reasonably expected to result in personal injury. Reproduction in whole or in part is prohibited without the prior written consent of the copyright owner. The information presented in this document does not form part of any quotation or contract, is believed to be accurate and reliable and may be changed without notice.