

### 3 V, SUPER MINIMOLD SILICON MMIC MEDIUM OUTPUT POWER AMPLIFIER FOR MOBILE COMMUNICATIONS

#### DESCRIPTION

The  $\mu$ PC2762TB,  $\mu$ PC2763TB and  $\mu$ PC2771TB are silicon monolithic integrated circuits designed as amplifier for mobile communications. Each of the ICs is packaged in super minimold package which is smaller than conventional minimold. The  $\mu$ PC2762TB,  $\mu$ PC2763TB and  $\mu$ PC2771TB have compatible pin connections and performance to  $\mu$ PC2762T,  $\mu$ PC2763T and  $\mu$ PC2771T of conventional minimold version. So, in the case of reducing your system size,  $\mu$ PC2762TB,  $\mu$ PC2763TB and  $\mu$ PC2771TB are suitable to replace from  $\mu$ PC2762T,  $\mu$ PC2763T and  $\mu$ PC2771T.

These IC is manufactured using NEC's 20 GHz fr NESAT™III silicon bipolar process. This process uses silicon nitride passivation film and gold electrodes. These materials can protect chip surface from external pollution and prevent corrosion/migration. Thus, this IC has excellent performance, uniformity and reliability.

#### FEATURES

- High-density surface mounting : 6-pin super minimold package (2.0 × 1.25 × 0.9 mm)
- Supply voltage :  $V_{CC} = 2.7$  to 3.3 V
- Medium output power :  $\mu$ PC2762TB:  $P_{O(1\text{ dB})} = +8.0$  dBm TYP. @ 0.9 GHz  
 $\mu$ PC2763TB:  $P_{O(1\text{ dB})} = +9.5$  dBm TYP. @ 0.9 GHz  
 $\mu$ PC2771TB:  $P_{O(1\text{ dB})} = +11.5$  dBm TYP. @ 0.9 GHz
- Power gain :  $\mu$ PC2762TB:  $G_P = 13$  dB TYP. @ 0.9 GHz  
 $\mu$ PC2763TB:  $G_P = 20$  dB TYP. @ 0.9 GHz  
 $\mu$ PC2771TB:  $G_P = 21$  dB TYP. @ 0.9 GHz

#### APPLICATIONS

- Buffer amplifiers for mobile telephones:  $\mu$ PC2762TB,  $\mu$ PC2763TB
- PA driver for PDC800M :  $\mu$ PC2771TB

#### ORDERING INFORMATION

Part Number	Package	Marking	Supplying Form
$\mu$ PC2762TB-E3	6-pin super minimold	C1Z	Embossed tape 8 mm wide. 1, 2, 3 pins face to perforation side of the tape. Qty 3 kp/reel.
$\mu$ PC2763TB-E3		C2A	
$\mu$ PC2771TB-E3		C2H	

**Remark** To order evaluation samples, please contact your local NEC sales office.  
(Part number for sample order:  $\mu$ PC2762TB,  $\mu$ PC2763TB,  $\mu$ PC2771TB)

#### Caution Electro-static sensitive devices

The information in this document is subject to change without notice. Before using this document, please confirm that this is the latest version.  
Not all devices/types available in every country. Please check with local NEC representative for availability and additional information.

**PIN CONNECTIONS**

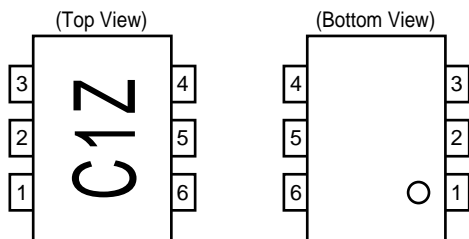

Marking is an example of  $\mu$ PC2762TB

Pin No.	Pin Name
1	INPUT
2	GND
3	GND
4	OUTPUT
5	GND
6	V <sub>cc</sub>

★ **PRODUCT LINE-UP** (T<sub>A</sub> = +25 °C, V<sub>CC</sub> = V<sub>out</sub> = 3.0 V, Z<sub>L</sub> = Z<sub>s</sub> = 50 Ω)

Part No.	f <sub>u</sub> (GHz)	P <sub>O</sub> (1 dB) (dBm)	P <sub>O</sub> (sat) (dBm)	G <sub>P</sub> (dB)	I <sub>cc</sub> (mA)	Package	Marking
$\mu$ PC2762T	2.9	+8.0	+9.0	13	26.5	6-pin minimold	C1Z
$\mu$ PC2762TB						6-pin super minimold	
$\mu$ PC2763T	2.7	+9.5	+11.0	20	27.0	6-pin minimold	C2A
$\mu$ PC2763TB						6-pin super minimold	
$\mu$ PC2771T	2.2	+11.5	+12.5	21	36.0	6-pin minimold	C2H
$\mu$ PC2771TB						6-pin super minimold	

**Remark** Typical performance. Please refer to ELECTRICAL CHARACTERISTICS in detail.

**Notice** The package size distinguishes between minimold and super minimold.

SYSTEM APPLICATION EXAMPLE

Digital cellular telephone

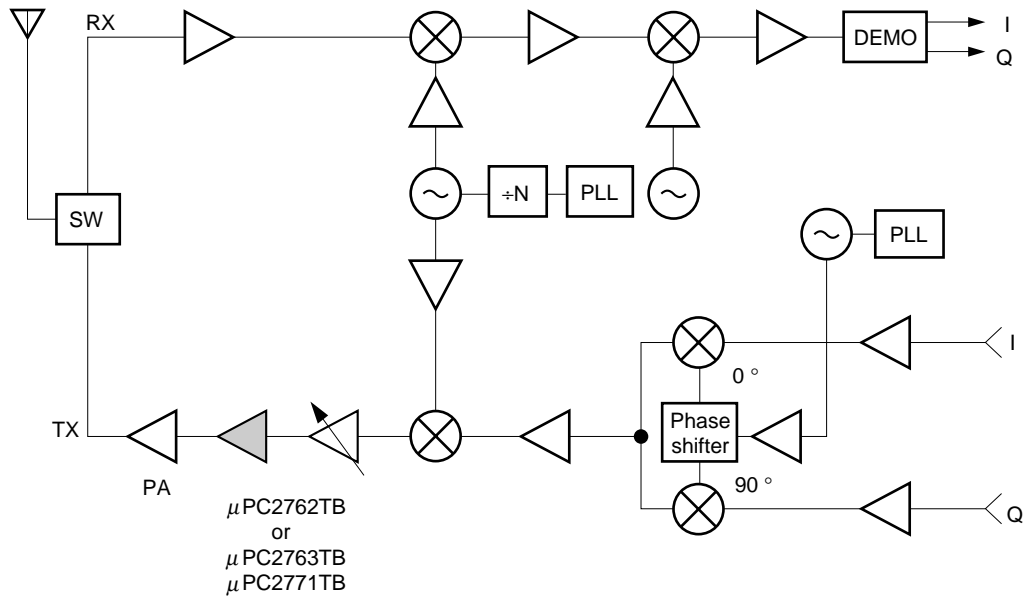

**Note** The insertion point is different due to the specifications of conjunct devices.  
For conjunction with your devices, refer to the data sheets to confirm their combination.

**PIN EXPLANATION**

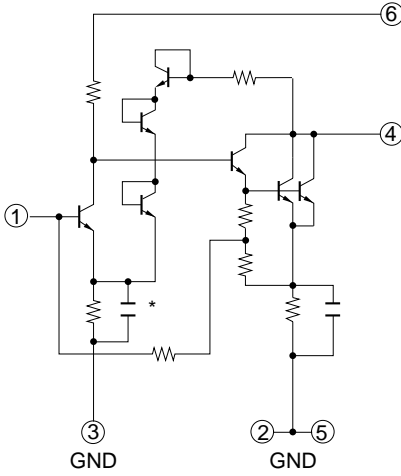
Pin No.	Pin Name	Applied Voltage (V)	Pin Voltage (V) <sup>Note</sup>	Function and Applications	Internal Equivalent Circuit
1	INPUT	–	1.31  1.01  0.97	Signal input pin. A internal matching circuit, configured with resistors, enables 50 $\Omega$ connection over a wide band. A multi-feedback circuit is designed to cancel the deviations of $h_{FE}$ and resistance. This pin must be coupled to signal source with capacitor for DC cut.	 <p>* <math>\mu</math>PC2762TB does not have this capacitance.</p>
4	OUTPUT	Voltage as same as $V_{CC}$ through external inductor	–	Signal output pin. The inductor must be attached between $V_{CC}$ and output pins to supply current to the internal output transistors.	
6	$V_{CC}$	2.7 to 3.3	–	Power supply pin, which biases the internal input transistor. This pin should be externally equipped with bypass capacitor to minimize its impedance.	
2 3 5	GND	0	–	Ground pin. This pin should be connected to system ground with minimum inductance. Ground pattern on the board should be formed as wide as possible. All the ground pins must be connected together with wide ground pattern to decrease impedance difference.	

**Note** Pin voltage is measured at  $V_{CC} = 3.0$  V. Above:  $\mu$ PC2762TB, Center:  $\mu$ PC2763TB, Below:  $\mu$ PC2771TB.

**ABSOLUTE MAXIMUM RATINGS**

Parameter	Symbol	Conditions	Ratings		Unit
			$\mu$ PC2762TB $\mu$ PC2763TB	$\mu$ PC2771TB	
Supply Voltage	V <sub>cc</sub>	T <sub>A</sub> = +25 °C, pin 4 and 6	3.6		V
Total Circuit Current	I <sub>cc</sub>	T <sub>A</sub> = +25 °C	70	77.7	mA
Power Dissipation	P <sub>D</sub>	Mounted on double copper clad 50 × 50 × 1.6 mm epoxy glass PWB T <sub>A</sub> = +85 °C	200		mW
Operating Ambient Temperature	T <sub>A</sub>		-40 to +85		°C
Storage Temperature	T <sub>stg</sub>		-55 to +150		°C
Input Power	P <sub>in</sub>	T <sub>A</sub> = +25 °C	+10	+13	dBm

**RECOMMENDED OPERATING CONDITIONS**

Parameter	Symbol	MIN.	TYP.	MAX.	Unit	Remark
Supply Voltage	V <sub>cc</sub>	2.7	3.0	3.3	V	Same voltage should be applied to pin 4 and 6.
Operating Ambient Temperature	T <sub>A</sub>	-40	+25	+85	°C	-
Operating Frequency	f <sub>opt</sub>	0.8	-	1.9	GHz	Only for $\mu$ PC2771TB

ELECTRICAL CHARACTERISTICS (T<sub>A</sub> = +25 °C, V<sub>CC</sub> = V<sub>out</sub> = 3.0 V, Z<sub>L</sub> = Z<sub>S</sub> = 50 Ω)

$\mu$ PC2762TB,  $\mu$ PC2763TB

Parameter	Symbol	Test Conditions	$\mu$ PC2762TB			$\mu$ PC2763TB			Unit
			MIN.	TYP.	MAX.	MIN.	TYP.	MAX.	
Circuit Current	I <sub>CC</sub>	No signal	–	26.5	35.0	–	27.0	35.0	mA
Power Gain	G <sub>P</sub>	f = 0.9 GHz f = 1.9 GHz	11 11.5	13 15.5	16 17.5	18 18	20 21	23 24	dB
Noise Figure	NF	f = 0.9 GHz f = 1.9 GHz	– –	6.5 7.0	8.0 9.0	– –	5.5 5.5	7.0 7.5	dB
Upper Limit Operating Frequency	f <sub>u</sub>	3 dB down below from gain at f = 0.1 GHz	2.7	2.9	–	2.3	2.7	–	GHz
Isolation	ISL	f = 0.9 GHz f = 1.9 GHz	22 20	27 25	– –	25 24	30 29	– –	dB
Input Return Loss	RL <sub>in</sub>	f = 0.9 GHz f = 1.9 GHz	6.0 5.5	9.0 8.5	– –	8.0 8.0	11.0 11.0	– –	dB
Output Return Loss	RL <sub>out</sub>	f = 0.9 GHz f = 1.9 GHz	8.0 9.0	11.0 12.0	– –	5.0 6.0	7.0 9.0	– –	dB
1 dB Gain Compression Output Level	PO (1 dB)	f = 0.9 GHz f = 1.9 GHz	+5.5 +4.5	+8.0 +7.0	– –	+7.0 +4.0	+9.5 +6.5	– –	dBm

$\mu$ PC2771TB

Parameter	Symbol	Test Conditions	$\mu$ PC2771TB			Unit
			MIN.	TYP.	MAX.	
Circuit Current	I <sub>CC</sub>	No signal	–	36.0	45.0	mA
Power Gain	G <sub>P</sub>	f = 0.9 GHz f = 1.5 GHz	19 18	21 21	24 24	dB
Noise Figure	NF	f = 0.9 GHz f = 1.5 GHz	– –	6.0 6.0	7.5 7.5	dB
Upper Limit Operating Frequency	f <sub>u</sub>	3 dB down below from gain at f = 0.1 GHz	1.8	2.2	–	GHz
Isolation	ISL	f = 0.9 GHz f = 1.5 GHz	25 25	30 30	– –	dB
Input Return Loss	RL <sub>in</sub>	f = 0.9 GHz f = 1.5 GHz	10 10	14 14	– –	dB
Output Return Loss	RL <sub>out</sub>	f = 0.9 GHz f = 1.5 GHz	6.5 5.5	9.0 8.5	– –	dB
1 dB Gain Compression Output Level	PO (1 dB)	f = 0.9 GHz f = 1.5 GHz	+9.0 +7.0	+11.5 +9.5	– –	dBm
Saturated Output Power Level	PO (sat)	f = 0.9 GHz f = 1.5 GHz	– –	+12.5 +11	– –	dBm

STANDARD CHARACTERISTICS FOR REFERENCE ( $T_A = +25\text{ }^\circ\text{C}$ ,  $V_{CC} = V_{out} = 3.0\text{ V}$ ,  $Z_L = Z_S = 50\ \Omega$ )

$\mu$ PC2762TB,  $\mu$ PC2763TB

Parameter	Symbol	Test Conditions		Reference						Unit
				$\mu$ PC2762TB			$\mu$ PC2763TB			
				MIN.	TYP.	MAX.	MIN.	TYP.	MAX.	
Saturated Output Power Level	$P_{O(sat)}$	$f = 0.9\text{ GHz}$ $f = 1.9\text{ GHz}$		-	+9.0	-	-	+11.0	-	dBm
Adjacent channel power	$P_{adj}$	$f = 0.9\text{ GHz}$ $\pi/4\text{ QPSK wave}^{\text{Note}}$ $P_O = +4\text{ dBm}$	$\Delta f = \pm 50\text{ kHz}$	-	-64	-	-	-61	-	dBc
			$\Delta f = \pm 100\text{ kHz}$	-	-64	-	-	-62	-	dBc
Third order intermodulation distortion	$IM_3$	2 sine wave input. Output of each tone $P_{O(each)} = +4\text{ dBm}$	$f_1 = 0.900\text{ GHz}$ $f_2 = 0.902\text{ GHz}$	-	-16	-	-	-27	-	dBc
			$f_1 = 1.900\text{ GHz}$ $f_2 = 1.902\text{ GHz}$	-	-10	-	-	-14	-	dBc

★

$\mu$ PC2771TB

Parameter	Symbol	Test Conditions		Reference			Unit
				$\mu$ PC2771TB			
				MIN.	TYP.	MAX.	
Adjacent channel power 1	$P_{adj1}$	$f = 0.9\text{ GHz}$ $\pi/4\text{ QPSK wave}^{\text{Note}}$ $P_O = +7\text{ dBm}$	$\Delta f = \pm 50\text{ kHz}$ $\Delta f = \pm 100\text{ kHz}$	-	-61	-	dBc
Adjacent channel power 2	$P_{adj2}$	$f = 1.5\text{ GHz}$ $\pi/4\text{ QPSK wave}^{\text{Note}}$ $P_O = +7\text{ dBm}$	$\Delta f = \pm 50\text{ kHz}$ $\Delta f = \pm 100\text{ kHz}$	-	-59	-	dBc
Third order intermodulation distortion	$IM_3$	2 sine wave input. Output of each tone $P_{O(each)} = +7\text{ dBm}$	$f_1 = 0.900\text{ GHz}$ $f_2 = 0.902\text{ GHz}$	-	-18	-	dBc
			$f_1 = 1.500\text{ GHz}$ $f_2 = 1.502\text{ GHz}$	-	-12	-	dBc

**Note**  $\pi/4$  DQPSK modulated wave input, data rate 42 kbps, Filter roll off  $\alpha = 0.5$ , PN 9

TEST CIRCUIT

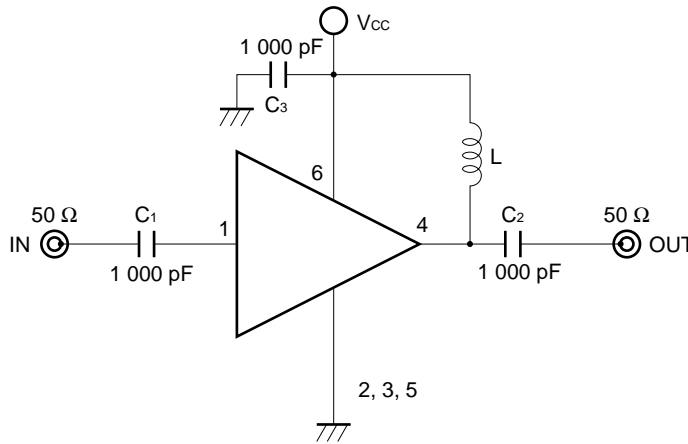

COMPONENTS OF TEST CIRCUIT FOR MEASURING ELECTRICAL CHARACTERISTICS

	Type	Value
C <sub>1</sub> , C <sub>2</sub>	Bias Tee	1 000 pF
C <sub>3</sub>	Capacitor	1 000 pF
L	Bias Tee	1 000 nH

EXAMPLE OF ACTUAL APPLICATION COMPONENTS

	Type	Value	Operating Frequency
C <sub>1</sub> to C <sub>3</sub>	Chip capacitor	1 000 pF	100 MHz or higher
L	Chip inductor	100 nH	100 MHz or higher
		10 nH	2.0 GHz or higher

INDUCTOR FOR THE OUTPUT PIN

The internal output transistor of this IC consumes 20 mA, to output medium power. To supply current for output transistor, connect an inductor between the Vcc pin (pin 6) and output pin (pin 4). Select large value inductance, as listed above.

The inductor has both DC and AC effects. In terms of DC, the inductor biases the output transistor with minimum voltage drop to output enable high level. In terms of AC, the inductor make output-port-impedance higher to get enough gain. In this case, large inductance and Q is suitable.

For above reason, select an inductance of 100 Ω or over impedance in the operating frequency. The gain is a peak in the operating frequency band, and suppressed at lower frequencies.

The recommendable inductance can be chosen from example of actual application components list as shown above.

CAPACITORS FOR THE Vcc, INPUT, AND OUTPUT PINS

Capacitors of 1 000 pF are recommendable as the bypass capacitor for the Vcc pin and the coupling capacitors for the input and output pins.

The bypass capacitor connected to the Vcc pin is used to minimize ground impedance of Vcc pin. So, stable bias can be supplied against Vcc fluctuation.

The coupling capacitors, connected to the input and output pins, are used to cut the DC and minimize RF serial impedance. Their capacitance are therefore selected as lower impedance against a 50 Ω load. The capacitors thus perform as high pass filters, suppressing low frequencies to DC.

To obtain a flat gain from 100 MHz upwards, 1 000 pF capacitors are used in the test circuit. In the case of under 10 MHz operation, increase the value of coupling capacitor such as 10 000 pF. Because the coupling capacitors are determined by equation,  $C = 1/(2\pi Rf_c)$ .



ILLUSTRATION OF THE TEST CIRCUIT ASSEMBLED ON EVALUATION BOARD

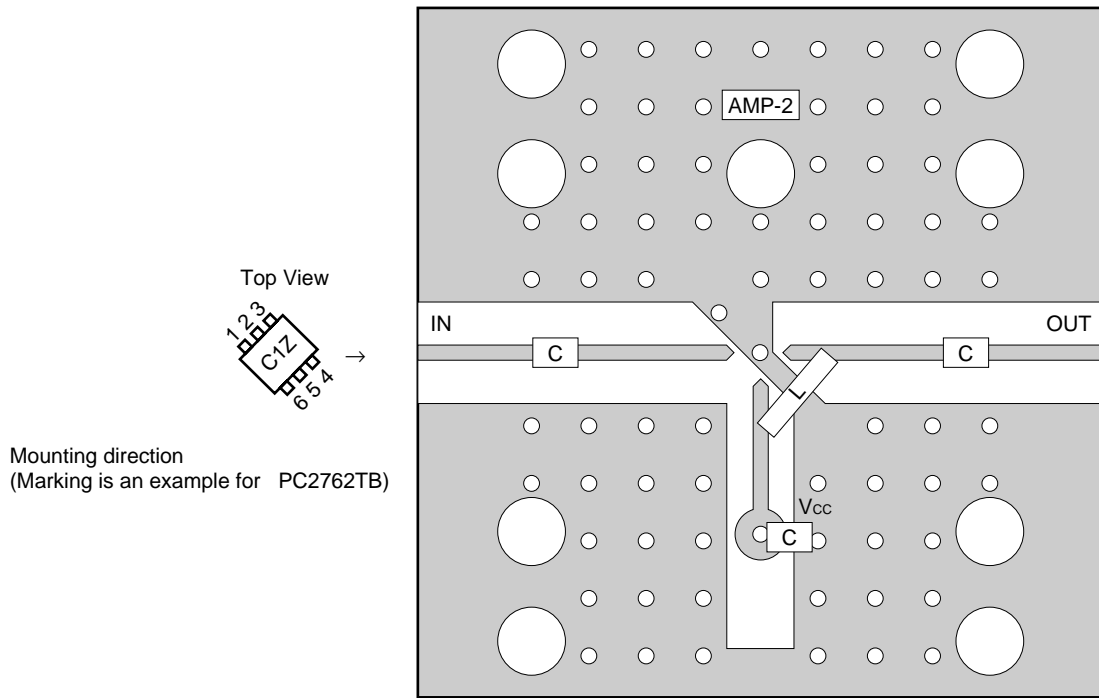

COMPONENT LIST

	Value
C	1 000 pF
L	Example: 10 nH

Notes

1. 30 × 30 × 0.4 mm double sided copper clad polyimide board.
2. Back side: GND pattern
3. Solder plated on pattern
4. ○ ○ : Through holes

For more information on the use of this IC, refer to the following application note: USAGE AND APPLICATION OF SILICON MEDIUM-POWER HIGH-FREQUENCY AMPLIFIER MMIC (P12152E).

★ TYPICAL CHARACTERISTICS (Unless otherwise specified,  $T_A = +25\text{ }^\circ\text{C}$ )

–  $\mu$ PC2762TB –

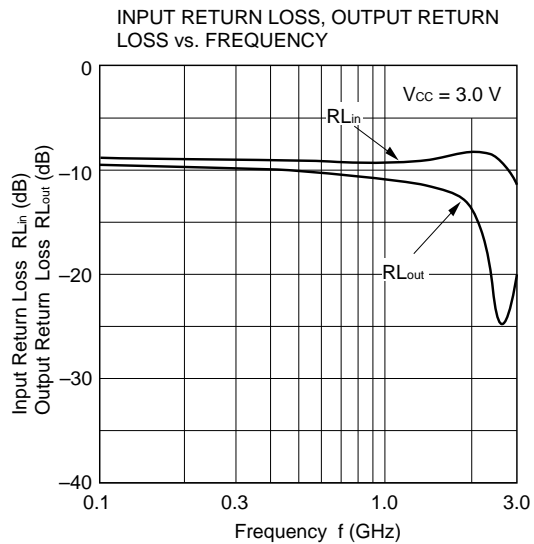
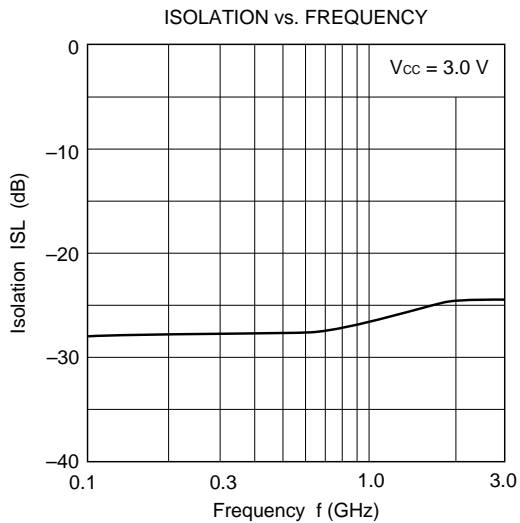
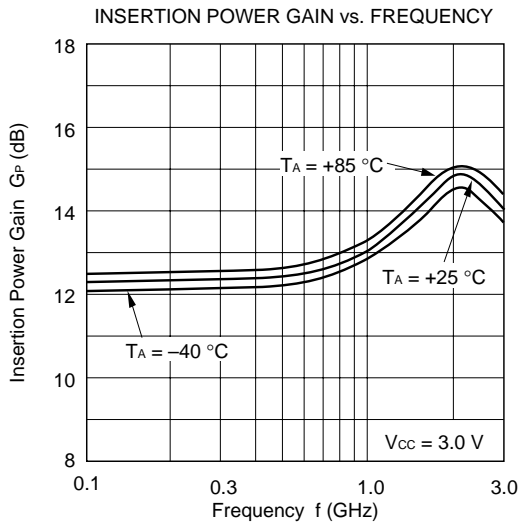
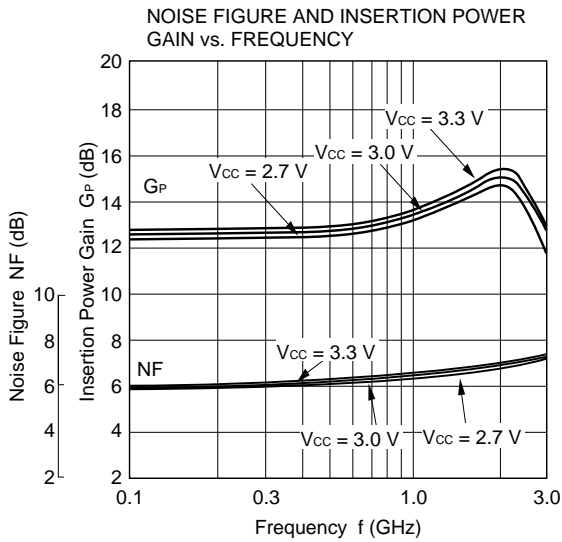
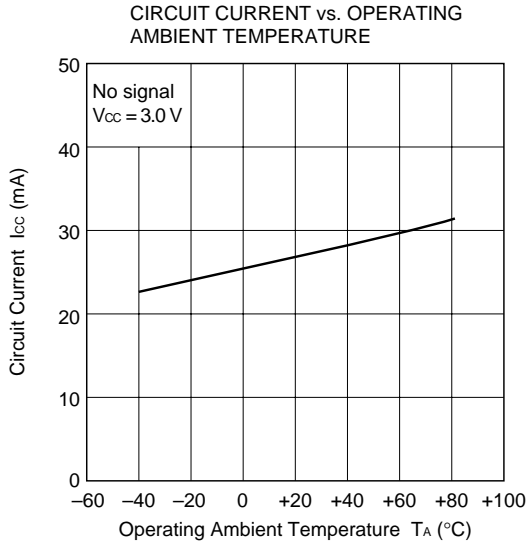
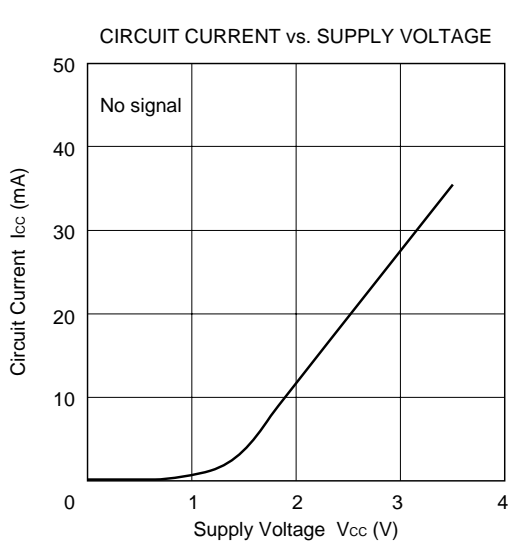

-  $\mu$ PC2762TB -

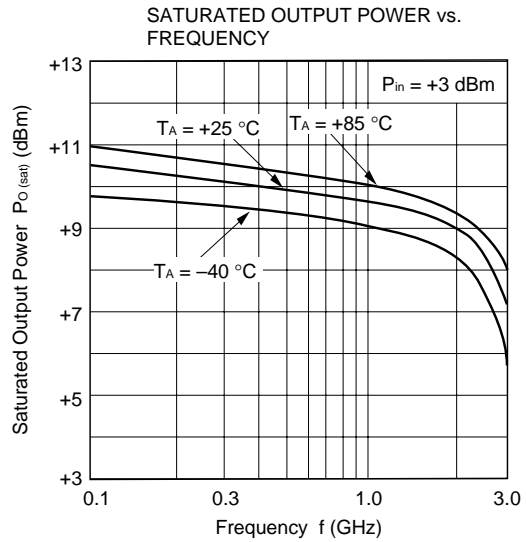
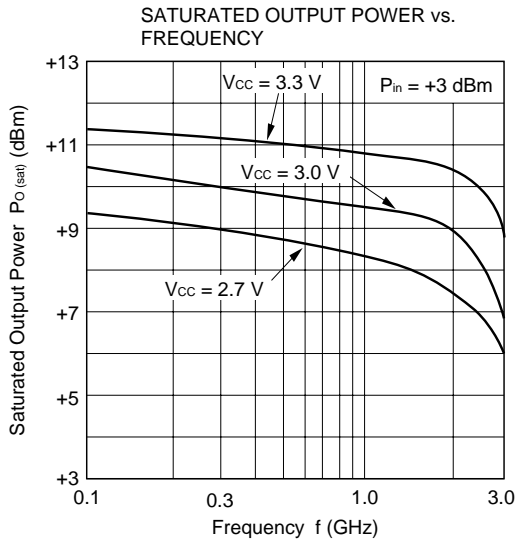
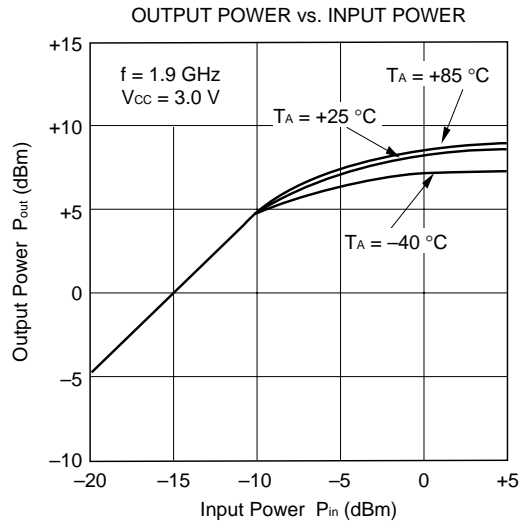
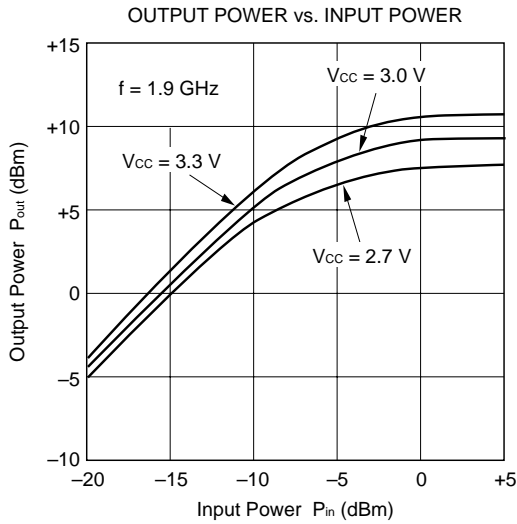
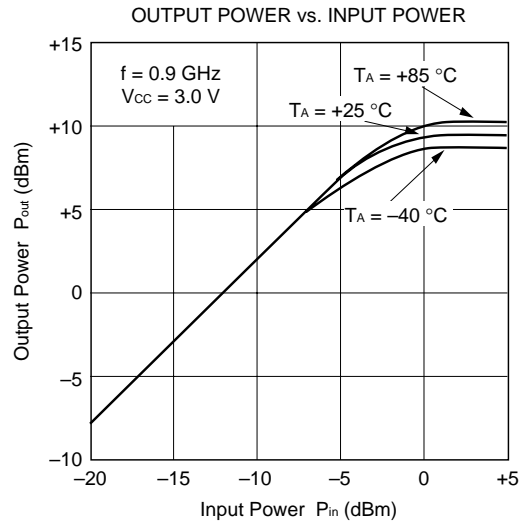
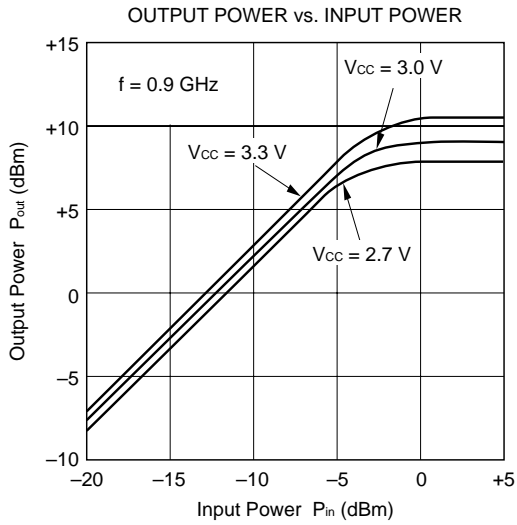

–  $\mu$ PC2762TB –

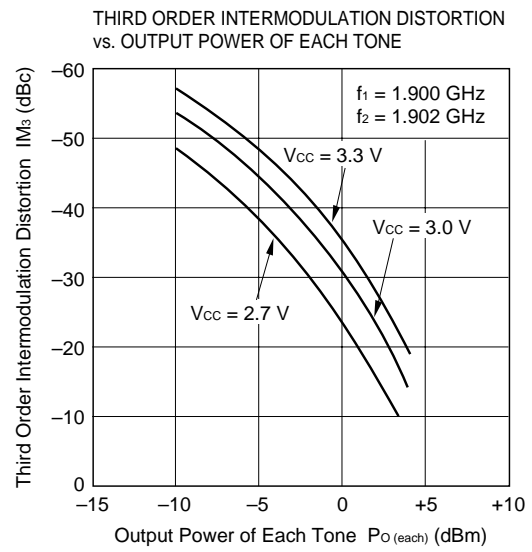
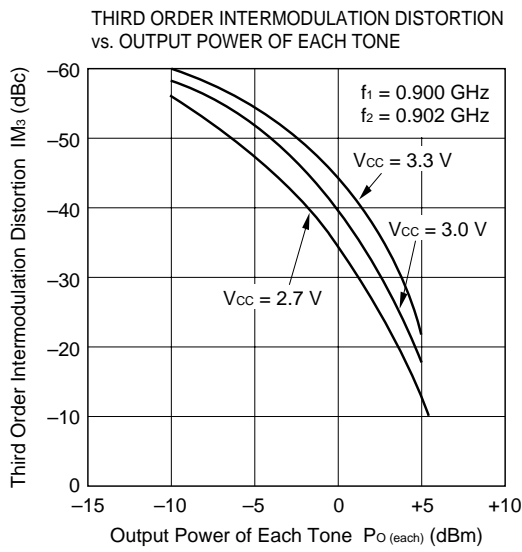

★ S-PARAMETER ( $T_A = +25\text{ }^\circ\text{C}$ ,  $V_{CC} = V_{out} = 3.0\text{ V}$ )

–  $\mu$ PC2762TB –

S<sub>11</sub>-FREQUENCY

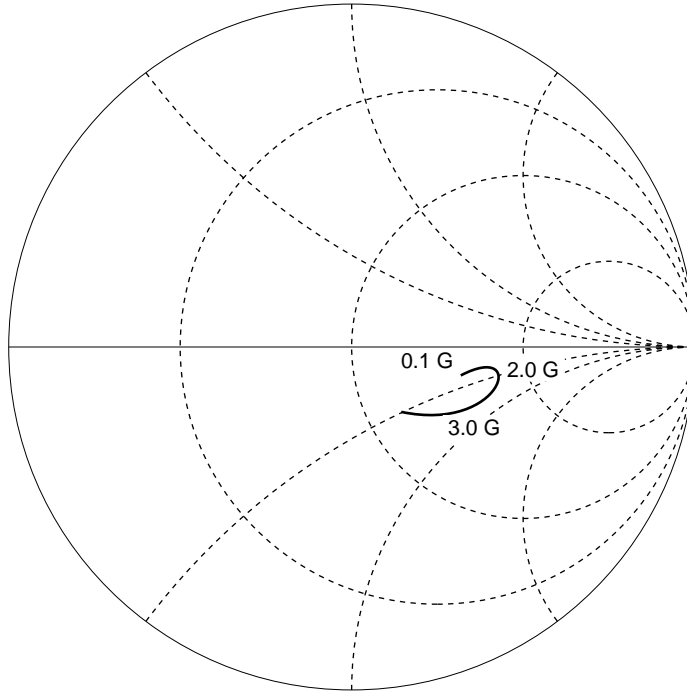

S<sub>22</sub>-FREQUENCY

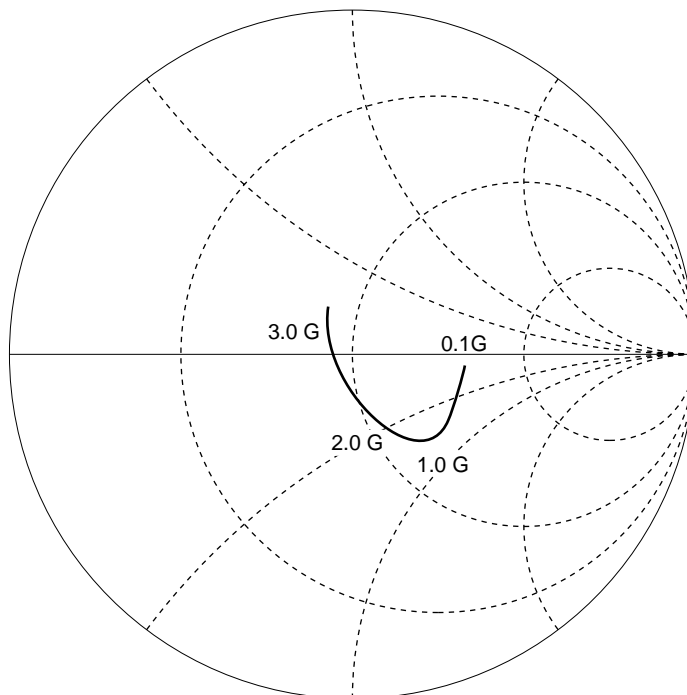

★ TYPICAL S-PARAMETER VALUES (T<sub>A</sub> = +25 °C)

$\mu$ PC2762TB

V<sub>CC</sub> = V<sub>out</sub> = 3.0 V, I<sub>CC</sub> = 29 mA

FREQUENCY MHz	S <sub>11</sub>		S <sub>21</sub>		S <sub>12</sub>		S <sub>22</sub>		K
	MAG.	ANG.	MAG.	ANG.	MAG.	ANG.	MAG.	ANG.	
100.0000	0.338	-1.3	4.560	-3.4	0.039	1.0	0.310	-5.5	2.23
200.0000	0.346	-2.0	4.581	-7.6	0.039	2.7	0.311	-9.5	2.20
300.0000	0.348	-1.2	4.616	-11.3	0.039	6.8	0.302	-12.3	2.20
400.0000	0.340	-1.9	4.661	-15.8	0.040	8.1	0.296	-16.2	2.18
500.0000	0.329	-3.1	4.689	-19.5	0.040	11.6	0.290	-20.2	2.20
600.0000	0.324	-6.2	4.726	-23.6	0.041	13.7	0.292	-24.1	2.12
700.0000	0.341	-8.1	4.844	-27.4	0.042	15.8	0.291	-26.2	2.01
800.0000	0.359	-7.6	4.927	-31.5	0.043	18.1	0.292	-28.3	1.90
900.0000	0.378	-6.5	5.057	-35.8	0.044	19.3	0.284	-30.9	1.77
1000.0000	0.375	-5.1	5.179	-41.0	0.045	20.3	0.280	-35.3	1.72
1100.0000	0.363	-5.2	5.306	-45.9	0.047	22.1	0.285	-40.0	1.64
1200.0000	0.353	-6.7	5.400	-51.0	0.047	23.7	0.288	-43.4	1.62
1300.0000	0.357	-8.8	5.567	-56.5	0.048	26.1	0.288	-45.7	1.54
1400.0000	0.377	-11.7	5.706	-61.7	0.049	24.5	0.285	-47.9	1.44
1500.0000	0.402	-12.7	5.820	-68.0	0.052	26.7	0.282	-52.8	1.32
1600.0000	0.414	-13.2	5.987	-73.7	0.052	26.8	0.285	-58.1	1.27
1700.0000	0.426	-13.6	6.081	-80.1	0.055	29.0	0.288	-62.0	1.18
1800.0000	0.434	-16.1	6.182	-86.7	0.056	28.2	0.291	-66.1	1.14
1900.0000	0.448	-19.0	6.229	-93.2	0.057	28.5	0.286	-70.4	1.09
2000.0000	0.463	-21.7	6.328	-99.7	0.057	28.0	0.282	-76.2	1.07
2100.0000	0.483	-23.9	6.382	-106.7	0.058	28.5	0.282	-81.5	1.01
2200.0000	0.492	-25.8	6.431	-113.8	0.058	29.0	0.282	-86.9	0.99
2300.0000	0.492	-29.7	6.424	-121.2	0.060	30.1	0.278	-91.7	0.99
2400.0000	0.486	-34.6	6.329	-128.8	0.060	30.2	0.268	-98.4	1.01
2500.0000	0.489	-40.4	6.146	-136.1	0.062	31.1	0.260	-104.5	1.02
2600.0000	0.500	-44.6	5.997	-143.1	0.061	32.1	0.251	-111.3	1.05
2700.0000	0.511	-48.5	5.822	-149.9	0.064	31.4	0.248	-116.7	1.03
2800.0000	0.511	-50.4	5.693	-157.0	0.066	34.0	0.237	-121.5	1.04
2900.0000	0.494	-52.9	5.553	-163.0	0.065	33.8	0.222	-128.3	1.11
3000.0000	0.465	-55.9	5.334	-169.5	0.065	35.5	0.203	-134.5	1.20
3100.0000	0.441	-60.6	5.157	-175.5	0.066	35.5	0.189	-141.1	1.27

★ TYPICAL CHARACTERISTICS (Unless otherwise specified,  $T_A = +25\text{ }^\circ\text{C}$ )

–  $\mu$ PC2763TB –

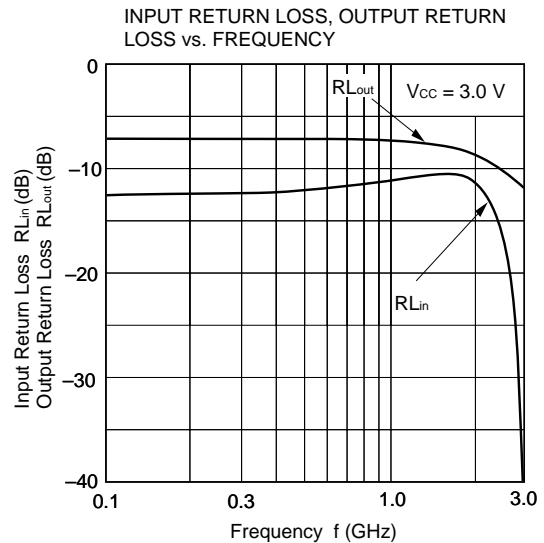
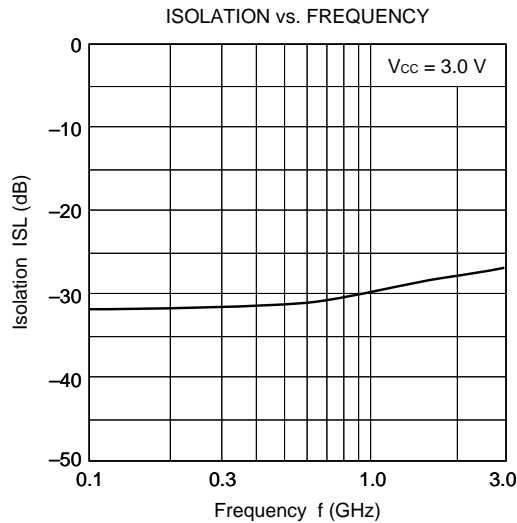
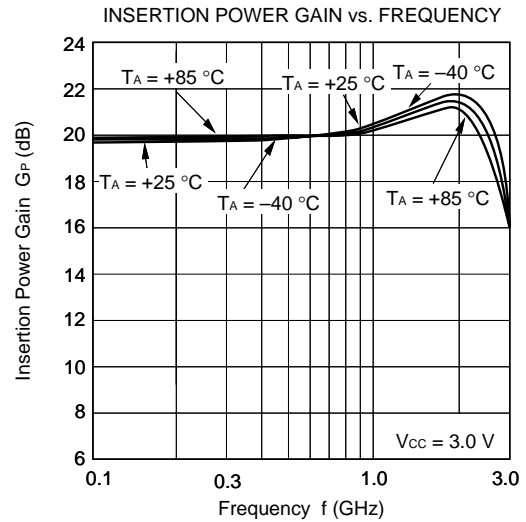
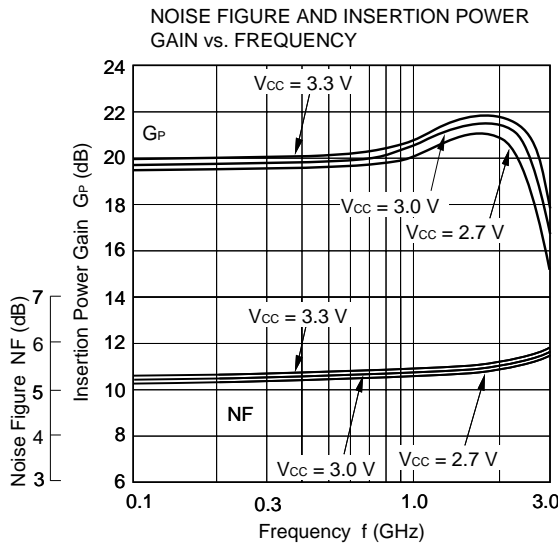
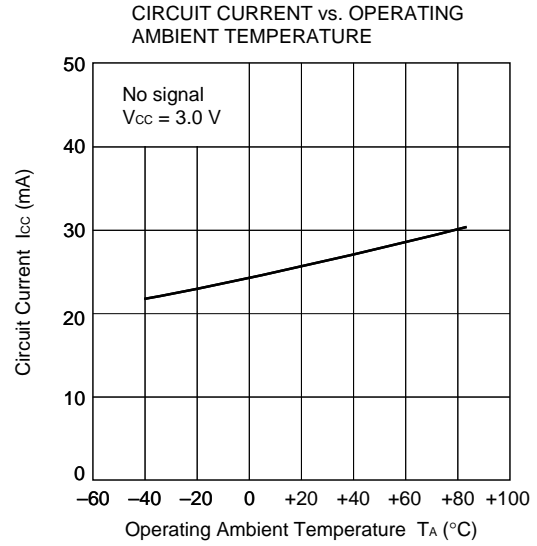
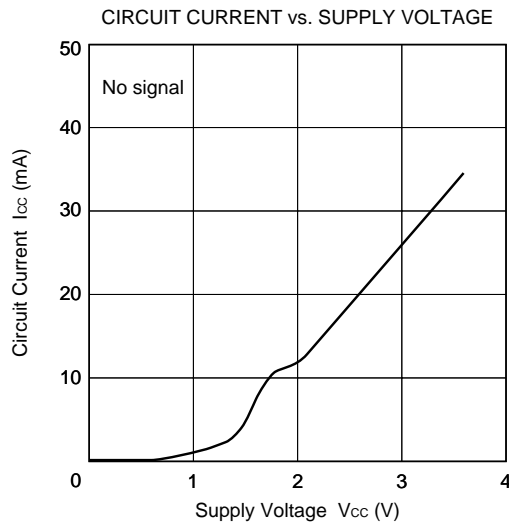

–  $\mu$ PC2763TB –

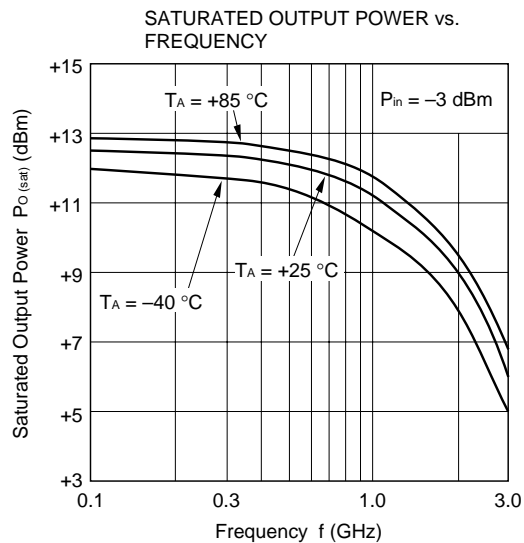
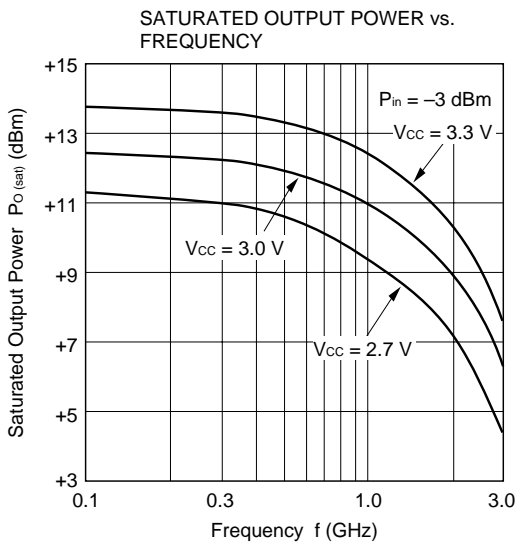
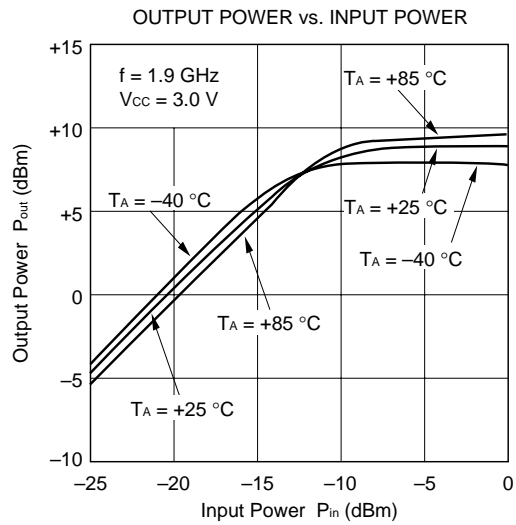
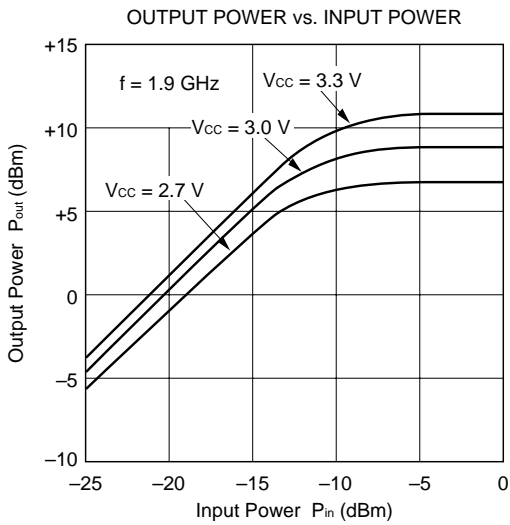
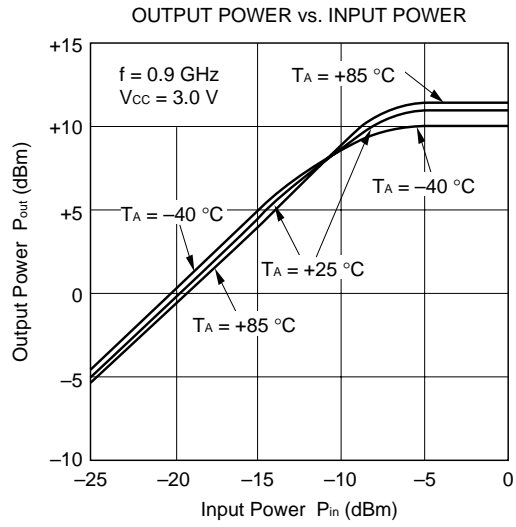
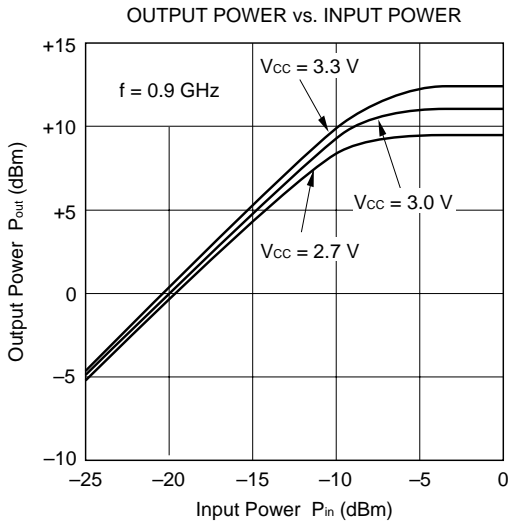



–  $\mu$ PC2763TB –

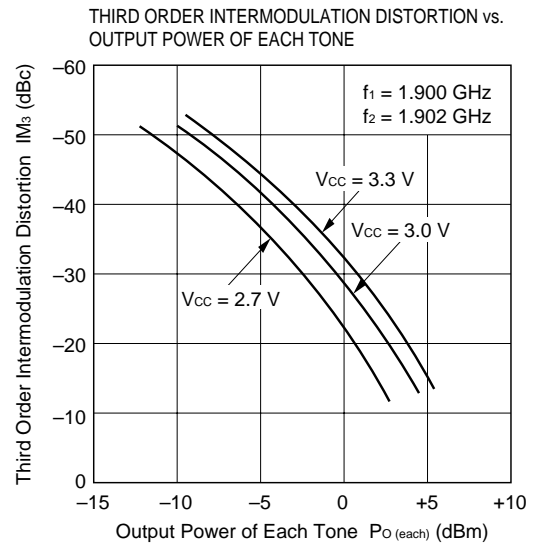
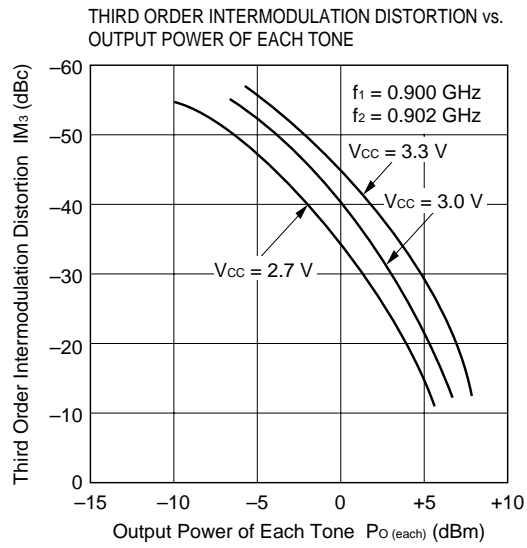

★ S-PARAMETER ( $T_A = +25\text{ }^\circ\text{C}$ ,  $V_{CC} = V_{out} = 3.0\text{ V}$ )

–  $\mu$ PC2763TB –

**S<sub>11</sub>-FREQUENCY**

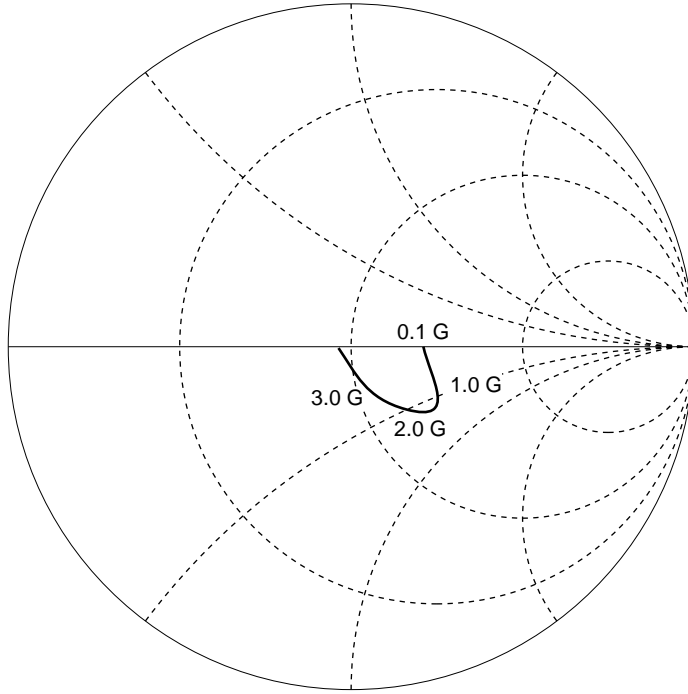

**S<sub>22</sub>-FREQUENCY**

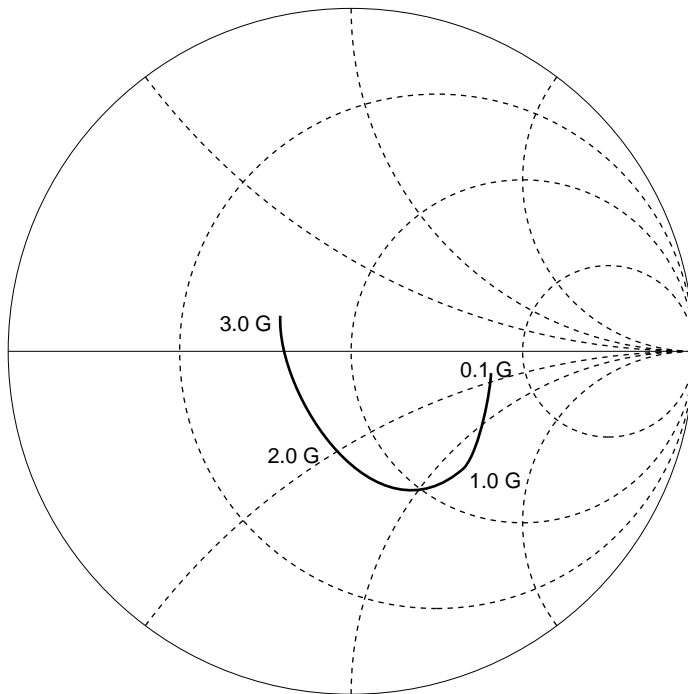

★ TYPICAL S-PARAMETER VALUES (T<sub>A</sub> = +25 °C)

μPC2763TB

V<sub>CC</sub> = V<sub>out</sub> = 3.0 V, I<sub>CC</sub> = 28 mA

FREQUENCY MHz	S <sub>11</sub>		S <sub>21</sub>		S <sub>12</sub>		S <sub>22</sub>		K
	MAG.	ANG.	MAG.	ANG.	MAG.	ANG.	MAG.	ANG.	
100.0000	0.231	-1.4	10.210	-3.8	0.023	2.4	0.406	-4.1	1.68
200.0000	0.242	-0.2	10.305	-8.5	0.023	7.8	0.412	-7.5	1.66
300.0000	0.250	2.7	10.464	-12.9	0.024	9.3	0.407	-9.9	1.58
400.0000	0.245	2.8	10.655	-18.2	0.024	13.4	0.407	-13.9	1.55
500.0000	0.242	2.0	10.863	-22.8	0.026	16.1	0.405	-17.6	1.44
600.0000	0.241	-2.2	11.093	-28.1	0.027	19.9	0.414	-21.6	1.37
700.0000	0.263	-5.3	11.544	-33.2	0.028	22.3	0.419	-24.6	1.25
800.0000	0.291	-5.6	11.843	-39.0	0.029	22.5	0.424	-27.7	1.16
900.0000	0.316	-5.1	12.291	-45.1	0.029	23.9	0.424	-31.9	1.09
1000.0000	0.322	-4.0	12.676	-52.4	0.030	25.6	0.425	-37.1	1.02
1100.0000	0.318	-5.4	13.066	-59.8	0.031	24.1	0.438	-42.5	0.96
1200.0000	0.309	-9.0	13.311	-67.3	0.031	27.0	0.442	-47.8	0.96
1300.0000	0.322	-14.2	13.661	-75.8	0.033	28.8	0.441	-51.2	0.90
1400.0000	0.344	-20.6	13.845	-83.9	0.033	28.5	0.434	-56.0	0.87
1500.0000	0.371	-23.7	13.824	-93.0	0.035	30.1	0.435	-62.2	0.82
1600.0000	0.380	-27.5	13.890	-101.5	0.035	28.1	0.439	-68.9	0.80
1700.0000	0.388	-30.6	13.634	-110.5	0.036	29.2	0.439	-74.6	0.78
1800.0000	0.378	-36.4	13.236	-119.6	0.035	29.9	0.428	-81.3	0.84
1900.0000	0.378	-42.1	12.724	-127.9	0.035	30.9	0.411	-87.0	0.89
2000.0000	0.375	-46.6	12.290	-136.1	0.035	32.9	0.393	-93.4	0.94
2100.0000	0.369	-50.5	11.707	-144.0	0.035	33.0	0.385	-99.6	0.99
2200.0000	0.351	-53.8	11.130	-151.7	0.036	35.7	0.373	-104.9	1.06
2300.0000	0.331	-59.8	10.524	-159.1	0.036	36.8	0.359	-110.3	1.13
2400.0000	0.306	-66.4	9.824	-165.9	0.034	38.7	0.336	-117.5	1.31
2500.0000	0.300	-73.1	9.152	-172.3	0.035	40.1	0.321	-123.3	1.41
2600.0000	0.294	-75.8	8.583	-178.2	0.034	43.8	0.306	-129.4	1.55
2700.0000	0.290	-77.1	8.029	-176.2	0.035	46.3	0.299	-133.9	1.58
2800.0000	0.270	-77.7	7.610	-170.6	0.037	47.7	0.288	-138.6	1.63
2900.0000	0.248	-78.7	7.240	-166.1	0.039	51.1	0.270	-143.6	1.67
3000.0000	0.219	-82.3	6.827	-161.2	0.039	53.6	0.253	-150.1	1.79
3100.0000	0.198	-88.7	6.516	-156.9	0.040	55.1	0.244	-156.2	1.88

★ TYPICAL CHARACTERISTICS (Unless otherwise specified,  $T_A = +25\text{ }^\circ\text{C}$ )

–  $\mu$ PC2771TB –

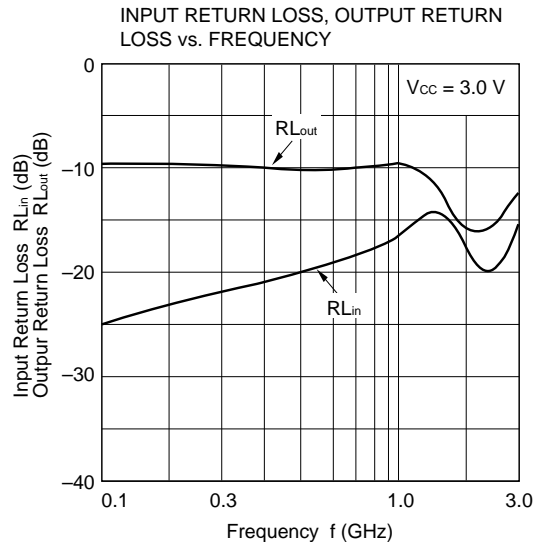
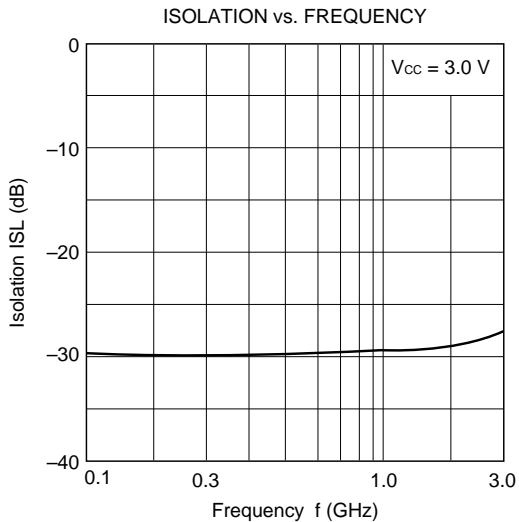
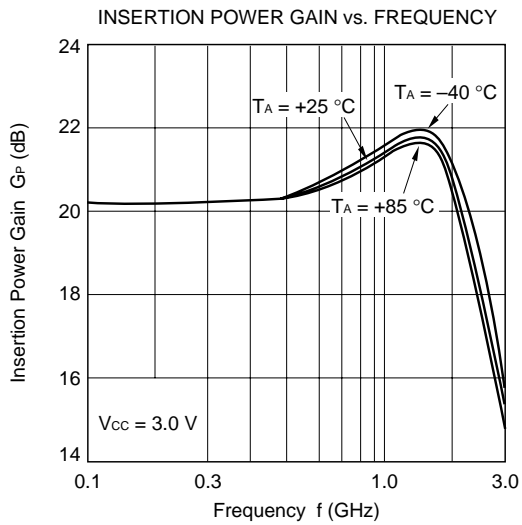
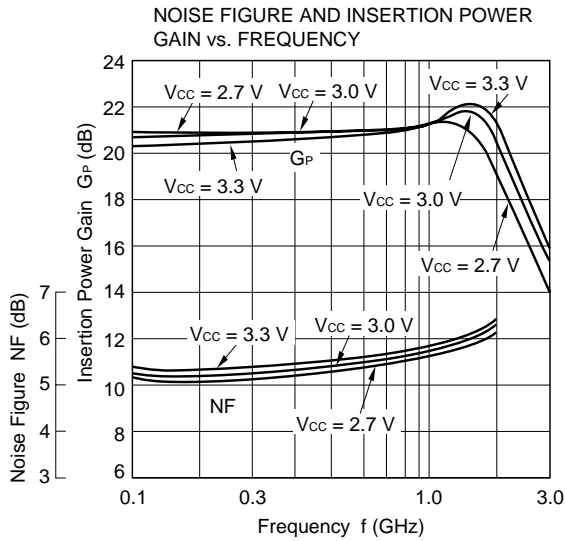
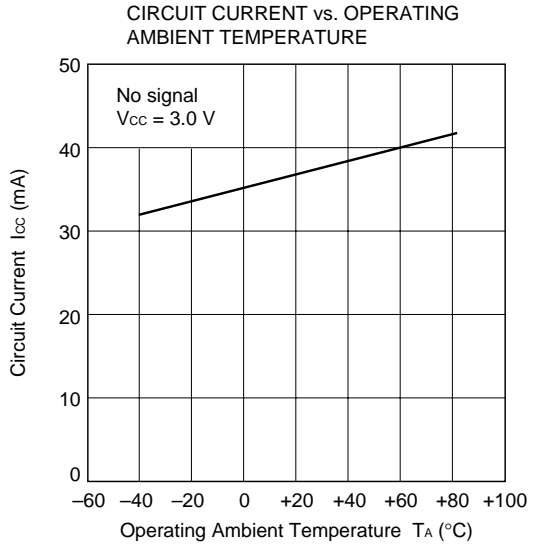
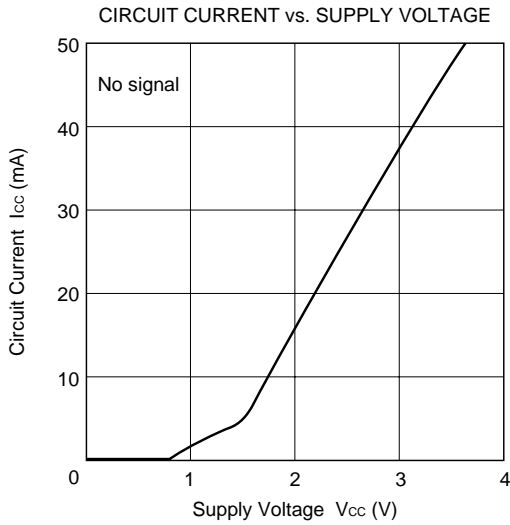

-  $\mu$ PC2771TB -

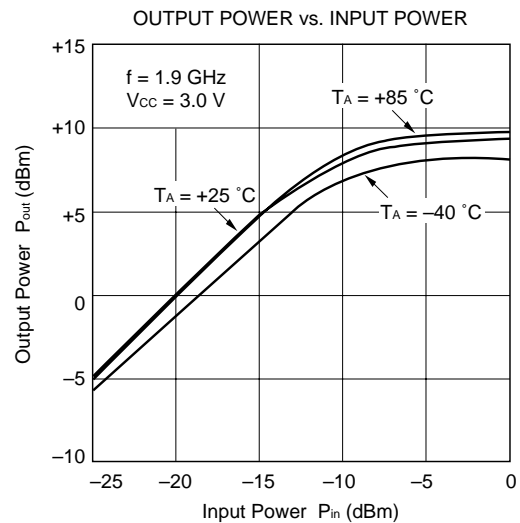
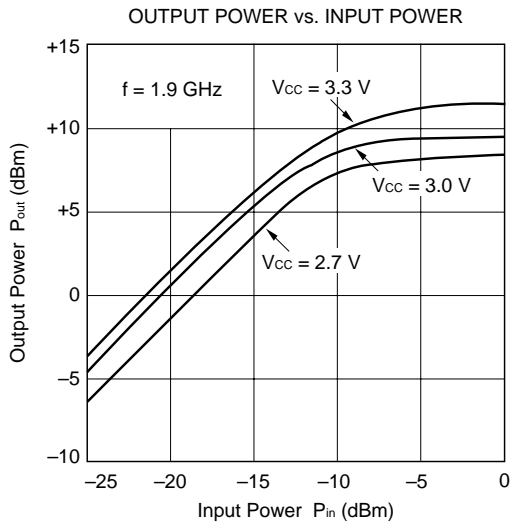
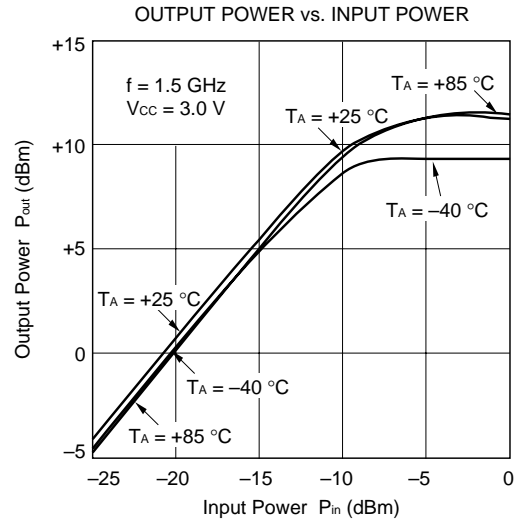
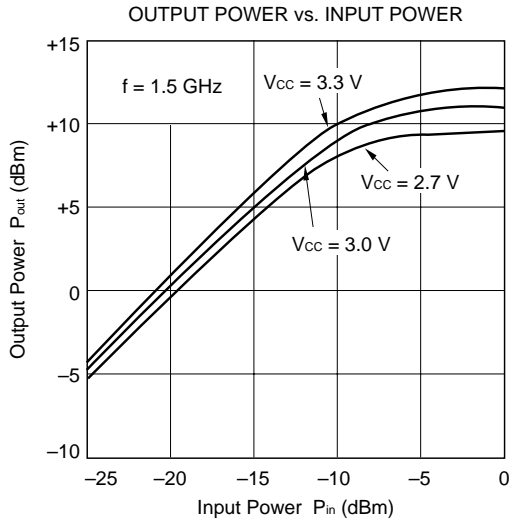
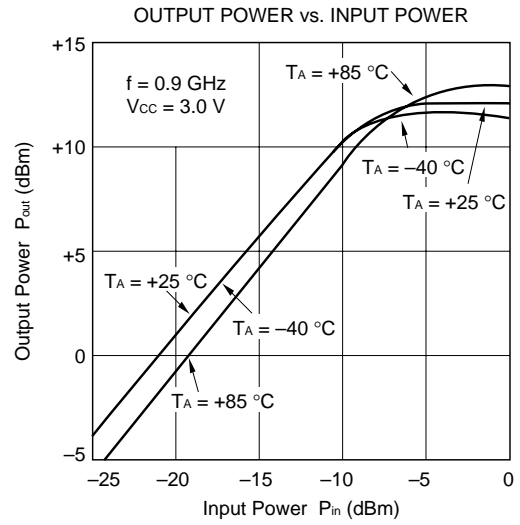
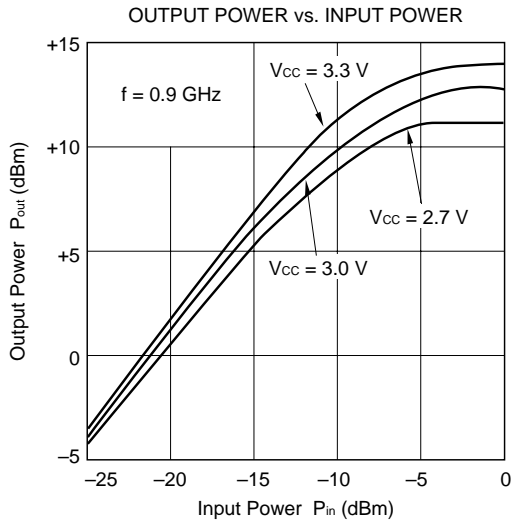

-  $\mu$ PC2771TB -

SATURATED OUTPUT POWER vs. FREQUENCY

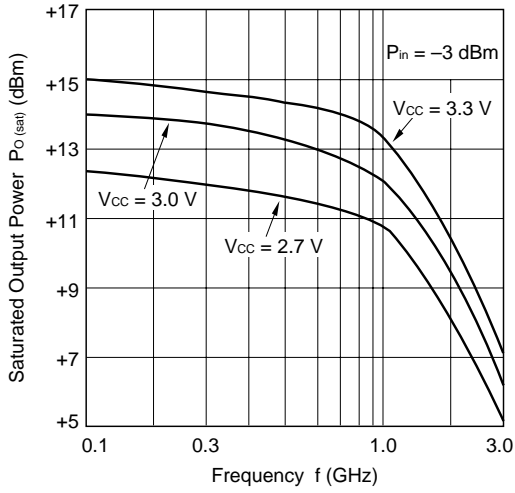

SATURATED OUTPUT POWER vs. FREQUENCY

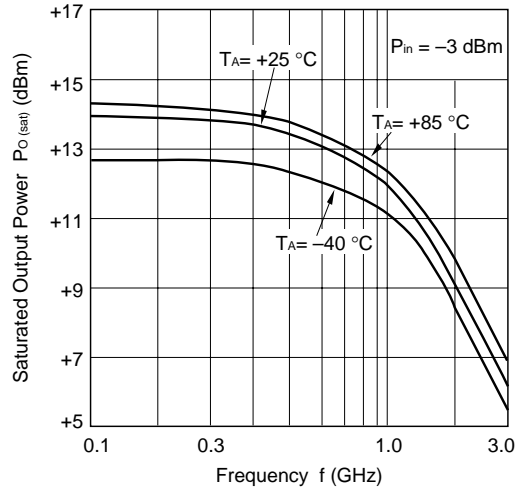

THIRD ORDER INTERMODULATION DISTORTION vs. OUTPUT POWER OF EACH TONE

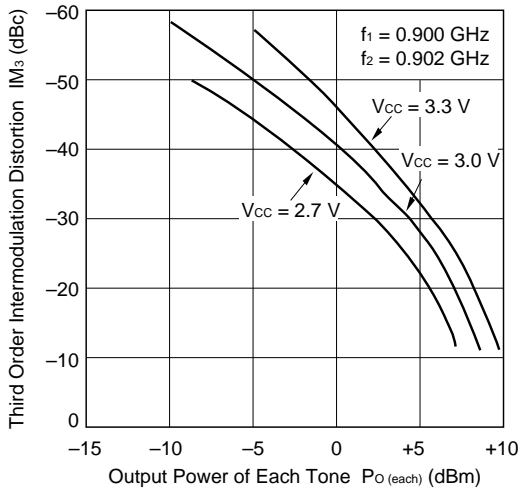

THIRD ORDER INTERMODULATION DISTORTION vs. OUTPUT POWER OF EACH TONE

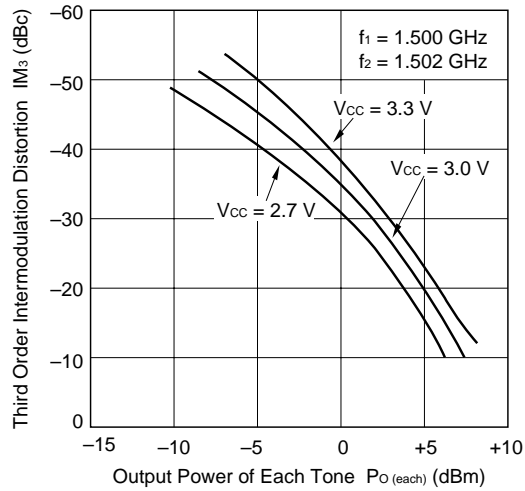

★ S-PARAMETER ( $T_A = +25\text{ }^\circ\text{C}$ ,  $V_{CC} = V_{out} = 3.0\text{ V}$ )

–  $\mu$ PC2771TB –

S<sub>11</sub>-FREQUENCY

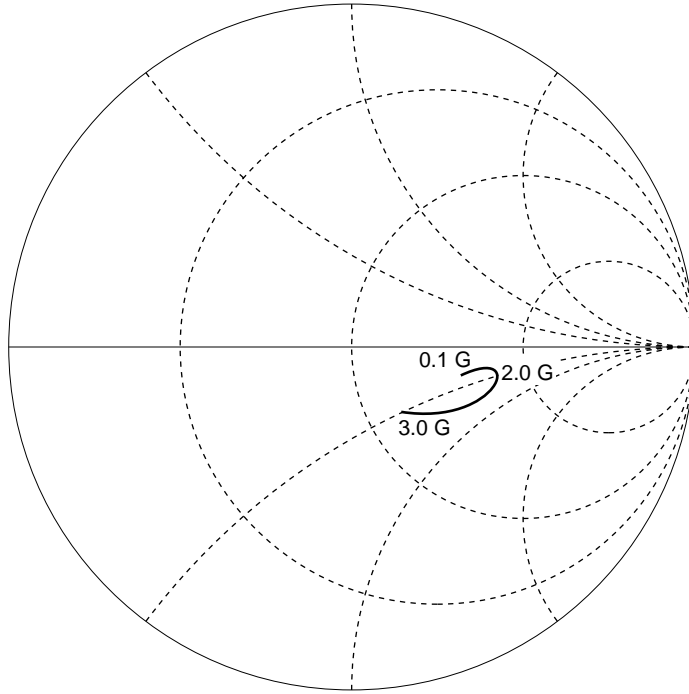

S<sub>22</sub>-FREQUENCY

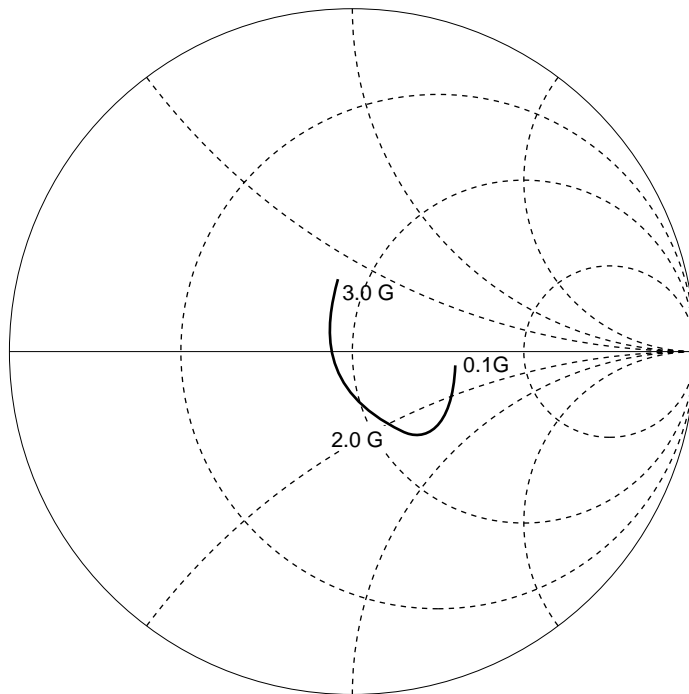

★ TYPICAL S-PARAMETER VALUES (T<sub>A</sub> = +25 °C)

$\mu$ PC2771TB

V<sub>CC</sub> = V<sub>out</sub> = 3.0 V, I<sub>CC</sub> = 35 mA

FREQUENCY MHz	S <sub>11</sub>		S <sub>21</sub>		S <sub>12</sub>		S <sub>22</sub>		K
	MAG.	ANG.	MAG.	ANG.	MAG.	ANG.	MAG.	ANG.	
100.0000	0.045	19.7	10.570	-4.7	0.028	0.8	0.327	-6.2	1.65
200.0000	0.057	37.0	10.638	-9.5	0.028	5.0	0.325	-11.5	1.63
300.0000	0.075	41.3	10.775	-14.1	0.029	8.6	0.323	-16.2	1.58
400.0000	0.090	43.3	11.004	-19.4	0.030	11.1	0.326	-20.9	1.49
500.0000	0.105	42.2	11.275	-24.4	0.030	14.9	0.331	-26.4	1.45
600.0000	0.118	40.2	11.586	-30.0	0.031	15.8	0.342	-32.0	1.37
700.0000	0.138	34.9	12.041	-35.9	0.031	19.8	0.350	-37.3	1.29
800.0000	0.163	32.5	12.367	-42.1	0.032	20.1	0.359	-42.8	1.20
900.0000	0.186	29.4	12.844	-48.8	0.032	23.2	0.361	-49.4	1.15
1000.0000	0.202	26.3	13.300	-56.6	0.032	23.9	0.371	-56.1	1.11
1100.0000	0.219	21.7	13.771	-64.6	0.033	24.9	0.389	-62.5	1.03
1200.0000	0.233	15.4	14.082	-73.5	0.033	26.6	0.400	-69.3	0.99
1300.0000	0.252	8.4	14.365	-83.2	0.036	28.8	0.405	-75.4	0.92
1400.0000	0.267	-0.1	14.336	-92.6	0.036	30.0	0.402	-83.6	0.91
1500.0000	0.285	-6.8	14.142	-102.4	0.036	32.0	0.406	-91.6	0.90
1600.0000	0.293	-13.9	13.929	-112.0	0.037	31.6	0.413	-99.3	0.89
1700.0000	0.304	-20.9	13.428	-121.6	0.039	32.5	0.414	-105.8	0.88
1800.0000	0.290	-28.1	12.722	-131.0	0.038	34.7	0.401	-113.7	0.96
1900.0000	0.285	-35.3	11.966	-139.6	0.038	36.1	0.387	-120.8	1.03
2000.0000	0.273	-41.8	11.232	-147.5	0.038	37.4	0.378	-127.6	1.09
2100.0000	0.267	-47.4	10.500	-154.8	0.039	39.1	0.366	-133.1	1.14
2200.0000	0.254	-51.6	9.815	-161.7	0.040	41.4	0.356	-138.0	1.20
2300.0000	0.237	-57.1	9.168	-168.0	0.041	43.7	0.342	-142.8	1.28
2400.0000	0.221	-61.1	8.570	-173.7	0.041	48.3	0.325	-148.3	1.37
2500.0000	0.212	-68.8	7.967	-179.7	0.042	48.3	0.322	-152.6	1.44
2600.0000	0.208	-72.2	7.507	-174.9	0.043	50.8	0.314	-156.7	1.49
2700.0000	0.202	-74.1	7.004	-170.0	0.045	53.7	0.309	-160.1	1.53
2800.0000	0.190	-76.3	6.667	-164.7	0.047	54.2	0.303	-164.0	1.56
2900.0000	0.178	-76.7	6.336	-160.7	0.051	57.7	0.292	-167.8	1.55
3000.0000	0.154	-82.3	6.003	-155.6	0.051	56.5	0.287	-172.8	1.62
3100.0000	0.147	-88.0	5.772	-151.3	0.054	59.3	0.279	-176.4	1.61



PACKAGE DIMENSIONS

6 pin super minimold (Unit: mm)

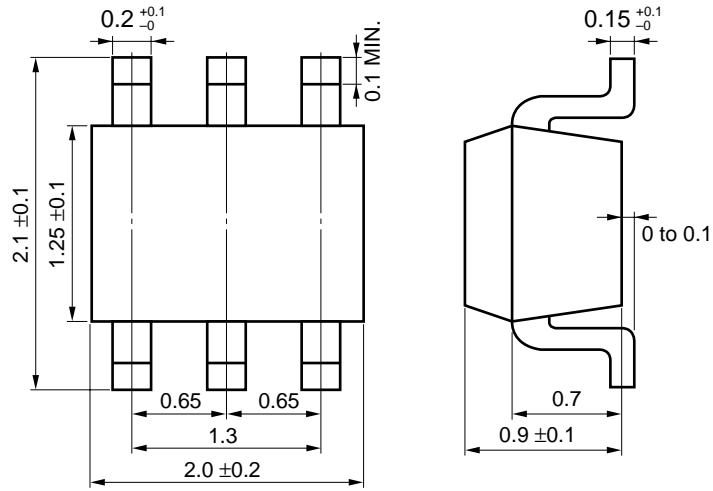

**NOTES ON CORRECT USE**

- (1) Observe precautions for handling because of electro-static sensitive devices.
- (2) Form a ground pattern as wide as possible to minimize ground impedance (to prevent undesired oscillation).  
All the ground pins must be connected together with wide ground pattern to decrease impedance difference.
- (3) The bypass capacitor should be attached to the Vcc pin.
- (4) The inductor must be attached between Vcc and output pins. The inductance value should be determined in accordance with desired frequency.
- (5) The DC cut capacitor must be attached to input pin.

**RECOMMENDED SOLDERING CONDITIONS**

This product should be soldered under the following recommended conditions. For soldering methods and conditions other than those recommended below, contact your NEC sales representative.

Soldering Method	Soldering Conditions	Recommended Condition Symbol
Infrared Reflow	Package peak temperature: 235 °C or below Time: 30 seconds or less (at 210 °C) Count: 3, Exposure limit: None <sup>Note</sup>	IR35-00-3
VPS	Package peak temperature: 215 °C or below Time: 40 seconds or less (at 200 °C) Count: 3, Exposure limit: None <sup>Note</sup>	VP15-00-3
Wave Soldering	Soldering bath temperature: 260 °C or below Time: 10 seconds or less Count: 1, Exposure limit: None <sup>Note</sup>	WS60-00-1
Partial Heating	Pin temperature: 300 °C Time: 3 seconds or less (per side of device) Exposure limit: None <sup>Note</sup>	—

**Note** After opening the dry pack, keep it in a place below 25 °C and 65 % RH for the allowable storage period.

**Caution** Do not use different soldering methods together (except for partial heating).

For details of recommended soldering conditions for surface mounting, refer to information document SEMICONDUCTOR DEVICE MOUNTING TECHNOLOGY MANUAL (C10535E).

[MEMO]

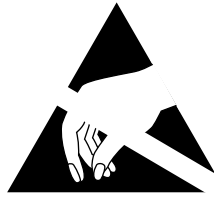

## ATTENTION

OBSERVE PRECAUTIONS  
FOR HANDLING  
ELECTROSTATIC  
SENSITIVE  
DEVICES

NESAT (NEC Silicon Advanced Technology) is a trademark of NEC Corporation.

- **The information in this document is subject to change without notice. Before using this document, please confirm that this is the latest version.**
- No part of this document may be copied or reproduced in any form or by any means without the prior written consent of NEC Corporation. NEC Corporation assumes no responsibility for any errors which may appear in this document.
- NEC Corporation does not assume any liability for infringement of patents, copyrights or other intellectual property rights of third parties by or arising from use of a device described herein or any other liability arising from use of such device. No license, either express, implied or otherwise, is granted under any patents, copyrights or other intellectual property rights of NEC Corporation or others.
- Descriptions of circuits, software, and other related information in this document are provided for illustrative purposes in semiconductor product operation and application examples. The incorporation of these circuits, software, and information in the design of the customer's equipment shall be done under the full responsibility of the customer. NEC Corporation assumes no responsibility for any losses incurred by the customer or third parties arising from the use of these circuits, software, and information.
- While NEC Corporation has been making continuous effort to enhance the reliability of its semiconductor devices, the possibility of defects cannot be eliminated entirely. To minimize risks of damage or injury to persons or property arising from a defect in an NEC semiconductor device, customers must incorporate sufficient safety measures in its design, such as redundancy, fire-containment, and anti-failure features.
- NEC devices are classified into the following three quality grades:  
"Standard", "Special", and "Specific". The Specific quality grade applies only to devices developed based on a customer designated "quality assurance program" for a specific application. The recommended applications of a device depend on its quality grade, as indicated below. Customers must check the quality grade of each device before using it in a particular application.
  - Standard: Computers, office equipment, communications equipment, test and measurement equipment, audio and visual equipment, home electronic appliances, machine tools, personal electronic equipment and industrial robots
  - Special: Transportation equipment (automobiles, trains, ships, etc.), traffic control systems, anti-disaster systems, anti-crime systems, safety equipment and medical equipment (not specifically designed for life support)
  - Specific: Aircraft, aerospace equipment, submersible repeaters, nuclear reactor control systems, life support systems or medical equipment for life support, etc.

The quality grade of NEC devices is "Standard" unless otherwise specified in NEC's Data Sheets or Data Books. If customers intend to use NEC devices for applications other than those specified for Standard quality grade, they should contact an NEC sales representative in advance.