

# BIPOLAR ANALOG INTEGRATED CIRCUIT

# $\mu$ PC3018, 3025

### LOW-SATURATION STABILIZED POWER SUPPLY WITH ON/OFF FUNCTION (1 A OUTPUT)

#### DESCRIPTION

The  $\mu$ PC3018 and 3025 are low-saturation type regulators with an output current of 1 A at respective output voltages of 1.8 and 2.5 V. These regulators are also provided with an ON/OFF function, which reduces the dissipation when there is no load, making them ideal for systems requiring low power consumption.

#### FEATURES

- ON/OFF pin for output control (active-high)
- Output current capacitance: 1 A
- Low minimum voltage difference between input and output ( $V_{DIF} = 0.5 \text{ V MAX. (when } I_o = 0.5 \text{ A)}$ )
- Output voltage accuracy:  $\pm 2\%$
- On-chip inrush current protection circuit for when input voltage rises (when input voltage is low)
- On-chip overcurrent limiter and thermal shutdown circuit
- On-chip safe operating area controller

#### PIN CONFIGURATION (Marking Side)

MP-3Z (5 pin), MP-3 (5 pin)

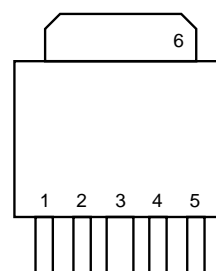

- 1: ON/OFF
- 2: INPUT
- 3: GND
- 4: OUTPUT
- 5: NC
- 6: GND (Fin)

#### ORDERING INFORMATION

Part Number	Package	Marking	Packing Type
$\mu$ PC30xxTJ	MP-3Z (5 pin)	30xx	• In bags
$\mu$ PC30xxTJ-E1	MP-3Z (5 pin)	30xx	• 16 mm embossed taping • Pin 1 in tape pull-out direction • 2000/reel
$\mu$ PC30xxTJ-E2	MP-3Z (5 pin)	30xx	• 16 mm embossed taping • Pin 1 in tape wind-up direction • 2000/reel
$\mu$ PC30xxHB	MP-3 (5 pin)	30xx	• In bags

“xx” in the part number and marking corresponds to the following output voltage.

#### Example

Output Voltage	Part Number	Marking
1.8 V	$\mu$ PC3018TJ	3018
2.5 V	$\mu$ PC3025TJ	3025

The information in this document is subject to change without notice. Before using this document, please confirm that this is the latest version.  
Not all devices/types available in every country. Please check with local NEC representative for availability and additional information.

BLOCK DIAGRAM

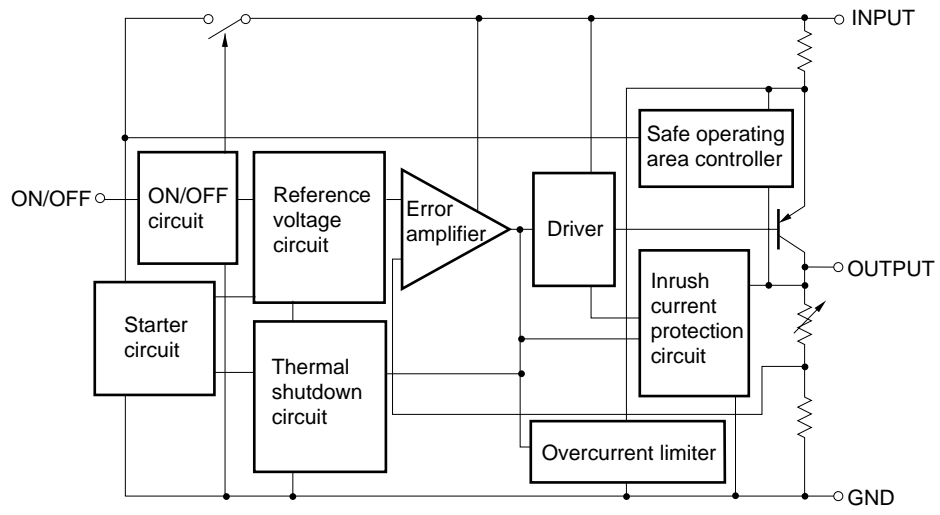

**ABSOLUTE MAXIMUM RATINGS (T<sub>A</sub> = 25°C unless otherwise specified)**

Parameter	Symbol	Rating	Unit
Input Voltage	V <sub>IN</sub>	-0.3 to +20	V
ON/OFF pin voltage	V <sub>ON/OFF</sub>	-0.3 to V <sub>IN</sub> + 0.3 V (however, V <sub>ON/OFF</sub> ≤ 20)	
Internal Power Dissipation (T <sub>C</sub> = 25°C)	P <sub>T</sub>	10 <sup>Note</sup>	W
Operating Ambient Temperature	T <sub>A</sub>	-30 to +85	°C
Operating Junction Temperature	T <sub>J</sub>	-30 to +150	°C
Storage Temperature	T <sub>stg</sub>	-55 to +150	°C
Thermal Resistance (junction to case)	R <sub>th(J-C)</sub>	12.5	°C/W
Thermal Resistance (junction to ambient)	R <sub>th(J-A)</sub>	125	°C/W

**Note** The total dissipation is limited by an internal circuit. Where T<sub>J</sub> > 150°C, an internal protection circuit cuts off the output.

**Caution** Product quality may suffer if the absolute maximum rating is exceeded even momentarily for any parameter. That is, the absolute maximum ratings are rated values at which the product is on the verge of suffering physical damage, and therefore the product must be used under conditions that ensure that the absolute maximum ratings are not exceeded.

**TYPICAL CONNECTION**

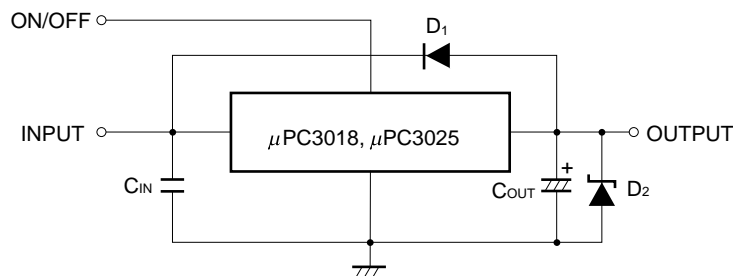

**C<sub>IN</sub>:** Must be 0.1 μF or more. Determine the capacitance in accordance with the line between the power supply smoothing circuit and input pin. Be sure to connect this capacitor to prevent abnormal oscillation. Use of a capacitor with excellent voltage and temperature characteristics, such as a film capacitor, is recommended. Note that some laminated ceramic capacitors have poor temperature and voltage characteristics. When using a laminated ceramic capacitor, the capacitance of 0.1 μF or more must be reserved in the voltage and temperature ranges used.

**C<sub>OUT</sub>:** Must be 10 μF or more. Be sure to connect this capacitor to prevent oscillation and to improve transient load stability.

Connect C<sub>IN</sub> and C<sub>OUT</sub> as close to the IC pins as possible (within 1 to 2 cm). Also, when using the device at 0°C or less, use an electrolytic capacitor with low impedance characteristics.

**D1:** Connect a diode if the voltage on the OUTPUT pin is higher than that on the INPUT pin.

**D2:** Connect a Schottky barrier diode if the voltage on the OUTPUT pin is lower than that on the GND pin.

**Caution** Ensure that voltage is not applied to the OUTPUT pin externally.

Supply V<sub>IN</sub> and V<sub>ON/OFF</sub> from different power supplies.

Design so that V<sub>IN</sub> and V<sub>ON/OFF</sub> either rise at the same time or V<sub>ON/OFF</sub> rises after V<sub>IN</sub>.

**RECOMMENDED OPERATING CONDITIONS**

Parameter	Symbol	Corresponding Model	MIN.	TYP.	MAX.	Unit
Input Voltage	V <sub>IN</sub>	μPC3018	2.8		16	V
		μPC3025	3.5		16	V
ON/OFF Pin Voltage	V <sub>ON/OFF</sub>	All models	0		V <sub>IN</sub>	
Output Current	I <sub>o</sub>	All models	0		1	A
Operating Ambient Temperature	T <sub>A</sub>	All models	-30		+85	°C
Operating Junction Temperature	T <sub>J</sub>	All models	-30		+125	°C

**Caution** The recommended operating range may be exceeded without causing any problems provided the absolute maximum ratings are not exceeded. However, if the device is operated in a way that exceeds the recommended operating conditions, the margin between the actual conditions of use and the absolute maximum ratings is small, and therefore thorough evaluation is necessary. The recommended operating conditions do not imply that the device can be used with all values at their maximum values.

**ELECTRICAL CHARACTERISTICS**

μPC3018 (T<sub>J</sub> = 25°C, V<sub>IN</sub> = 2.8 V, V<sub>ON/OFF</sub> = 2.8 V, I<sub>o</sub> = 0.5 A, C<sub>IN</sub> = 0.1 μF, C<sub>OUT</sub> = 10 μF, unless otherwise specified)

Parameter	Symbol	Conditions	MIN.	TYP.	MAX.	Unit
Output Voltage	V <sub>o</sub>		1.764	1.8	1.836	V
		0°C ≤ T <sub>J</sub> ≤ 125°C, 2.8 V ≤ V <sub>IN</sub> ≤ 5 V, 0 mA ≤ I <sub>o</sub> ≤ 1 A	(1.71)		(1.854)	
Line Regulation	REG <sub>IN</sub>	2.8 V ≤ V <sub>IN</sub> ≤ 16 V		6	25	mV
Load Regulation	REG <sub>L</sub>	0 A ≤ I <sub>o</sub> ≤ 1 A		7	30	mV
Quiescent Current	I <sub>BIAS</sub>	I <sub>o</sub> = 0 A		2	4	mA
		I <sub>o</sub> = 1 A		20	60	
Startup Quiescent Current	I <sub>BIAS (s)</sub>	V <sub>IN</sub> = 2.4 V, V <sub>ON/OFF</sub> = 2.0 V, I <sub>o</sub> = 0 A		10	30	mA
		V <sub>IN</sub> = 2.4 V, V <sub>ON/OFF</sub> = 2.0 V, I <sub>o</sub> = 1 A			80	
Quiescent Current Change	ΔI <sub>BIAS</sub>	0°C ≤ T <sub>J</sub> ≤ 125°C, 2.8 V ≤ V <sub>IN</sub> ≤ 16 V		2.9	20	mA
Output Noise Voltage	V <sub>n</sub>	10 Hz ≤ f ≤ 100 kHz		40		μV <sub>r.m.s.</sub>
Ripple Rejection	R•R	f = 120 Hz, 2.8 V ≤ V <sub>IN</sub> ≤ 9 V	(45)	60		dB
Dropout Voltage	V <sub>DIF</sub>	I <sub>o</sub> = 0.5 A		0.25	0.5	V
		0°C ≤ T <sub>J</sub> ≤ 125°C, I <sub>o</sub> = 1 A		0.7		
Short Circuit Current	I <sub>Oshort</sub>	V <sub>IN</sub> = 2.8 V	1.2	1.7	3.0	A
		V <sub>IN</sub> = 16 V		1.2		
Peak Output Current	I <sub>Opeak</sub>	V <sub>IN</sub> = 2.8 V	1.0	1.5	3.0	A
		V <sub>IN</sub> = 3.3 V	1.0	1.7	3.0	
		V <sub>IN</sub> = 16 V		1.1		
Temperature Coefficient of Output Voltage	ΔV <sub>o</sub> / ΔT	0°C ≤ T <sub>J</sub> ≤ 125°C, I <sub>o</sub> = 5 mA		-0.4		mV/°C
ON Voltage	V <sub>ON/OFF</sub>		2.0			V
OFF Voltage	V <sub>ON/OFF</sub>				0.8	V
ON/OFF Pin Current	I <sub>ON/OFF</sub>	V <sub>IN</sub> = 2.8 V, V <sub>ON/OFF</sub> = 2.8 V			90	μA
		V <sub>IN</sub> = 3.3 V, V <sub>ON/OFF</sub> = 3.3 V			110	
		V <sub>IN</sub> = 5 V, V <sub>ON/OFF</sub> = 5 V			160	
Standby Current	I <sub>BIAS (OFF)</sub>	V <sub>ON/OFF</sub> = 0 V			10	μA

**Remark** Values in parentheses are reference values obtained during product design.

μPC3025 (T<sub>J</sub> = 25°C, V<sub>IN</sub> = 3.5 V, V<sub>ON/OFF</sub> = 3.5 V, I<sub>o</sub> = 0.5 A, C<sub>IN</sub> = 0.1 μF, C<sub>OUT</sub> = 10 μF, unless otherwise specified)

Parameter	Symbol	Conditions	MIN.	TYP.	MAX.	Unit
Output Voltage	V <sub>o</sub>		2.45	2.5	2.55	V
		0°C ≤ T <sub>J</sub> ≤ 125°C, 3.5 V ≤ V <sub>IN</sub> ≤ 5 V, 0 mA ≤ I <sub>o</sub> ≤ 1 A	(2.375)		(2.575)	
Line Regulation	REG <sub>IN</sub>	3.5 V ≤ V <sub>IN</sub> ≤ 16 V		6	25	mV
Load Regulation	REG <sub>L</sub>	0 A ≤ I <sub>o</sub> ≤ 1 A		7	30	mV
Quiescent Current	I <sub>BIAS</sub>	I <sub>o</sub> = 0 A		2	4	mA
		I <sub>o</sub> = 1 A		20	60	
Startup Quiescent Current	I <sub>BIAS (s)</sub>	V <sub>IN</sub> = 2.4 V, V <sub>ON/OFF</sub> = 2.0 V, I <sub>o</sub> = 0 A		10	30	mA
		V <sub>IN</sub> = 3.0 V, V <sub>ON/OFF</sub> = 2.0 V, I <sub>o</sub> = 1 A			80	
Quiescent Current Change	ΔI <sub>BIAS</sub>	0°C ≤ T <sub>J</sub> ≤ 125°C, 3.5 V ≤ V <sub>IN</sub> ≤ 16 V		2.9	20	mA
Output Noise Voltage	V <sub>n</sub>	10 Hz ≤ f ≤ 100 kHz		40		μV <sub>r.m.s.</sub>
Ripple Rejection	R•R	f = 120 Hz, 3.5 V ≤ V <sub>IN</sub> ≤ 9 V	(45)	60		dB
Dropout Voltage	V <sub>DIF</sub>	I <sub>o</sub> = 0.5 A		0.25	0.5	V
		0°C ≤ T <sub>J</sub> ≤ 125°C, I <sub>o</sub> = 1 A		0.7		
Short Circuit Current	I <sub>Oshort</sub>	V <sub>IN</sub> = 3.5 V	1.2	1.7	3.0	A
		V <sub>IN</sub> = 16 V		1.2		
Peak Output Current	I <sub>Opeak</sub>	V <sub>IN</sub> = 3.5 V	1.0	1.5	3.0	A
		V <sub>IN</sub> = 5 V	1.0	2.1	3.0	
		V <sub>IN</sub> = 16 V		1.1		
Temperature Coefficient of Output Voltage	ΔV <sub>o</sub> / ΔT	0°C ≤ T <sub>J</sub> ≤ 125°C, I <sub>o</sub> = 5 mA		-0.5		mV/°C
ON Voltage	V <sub>ON/OFF</sub>		2.0			V
OFF Voltage	V <sub>ON/OFF</sub>				0.8	V
ON/OFF Pin Current	I <sub>ON/OFF</sub>	V <sub>IN</sub> = 3.5 V, V <sub>ON/OFF</sub> = 3.5 V			110	μA
		V <sub>IN</sub> = 5 V, V <sub>ON/OFF</sub> = 5 V			160	
Standby Current	I <sub>BIAS (OFF)</sub>	V <sub>ON/OFF</sub> = 0 V			10	μA

**Remark** Values in parentheses are reference values obtained during product design.

★ TYPICAL CHARACTERISTICS (Reference Values)

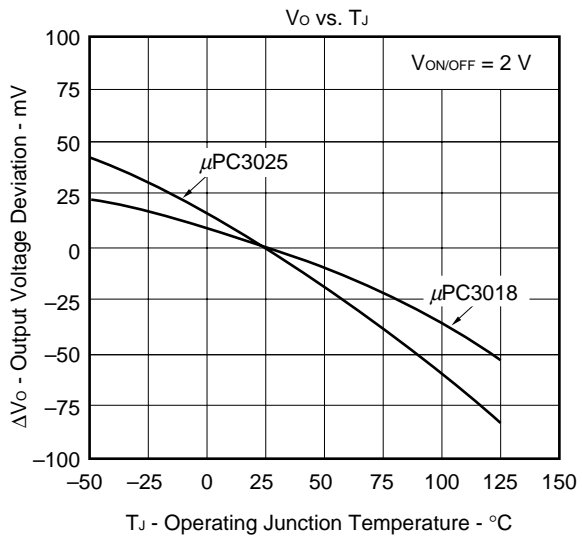
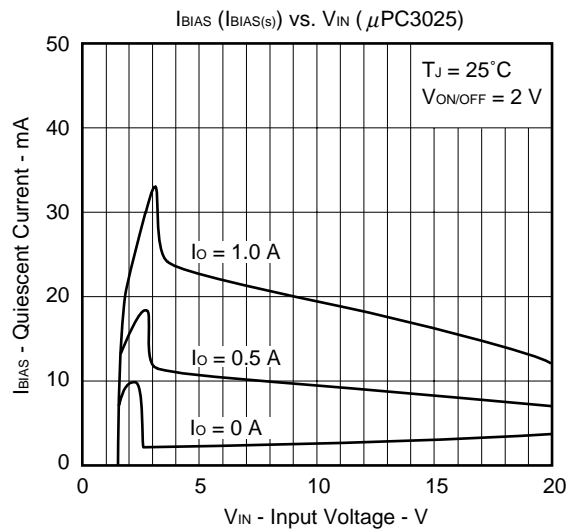
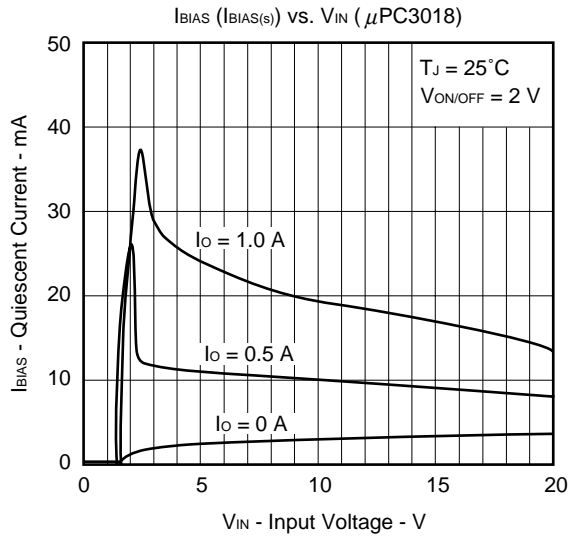
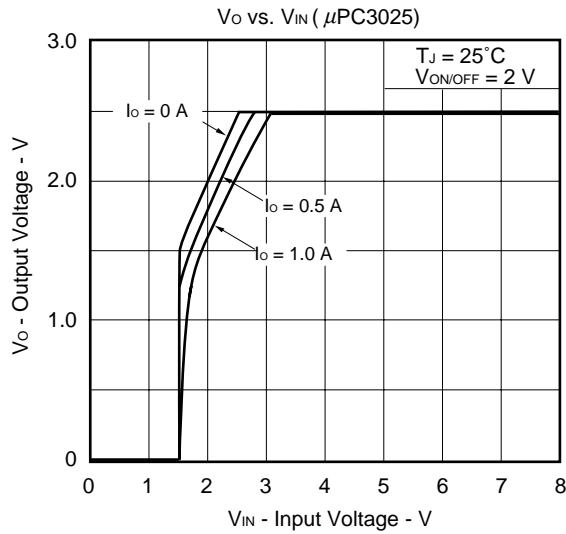
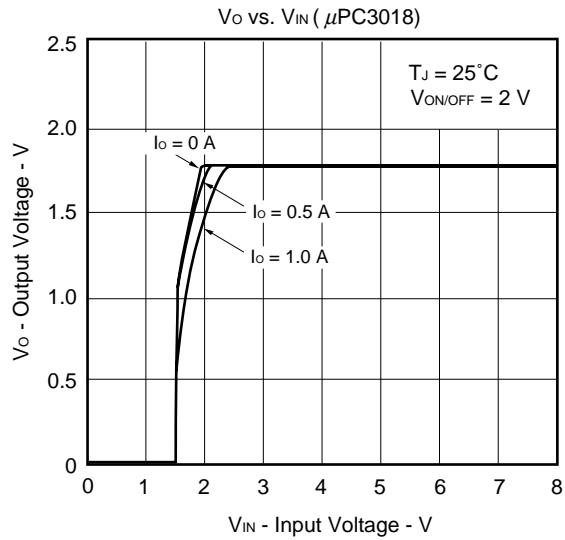
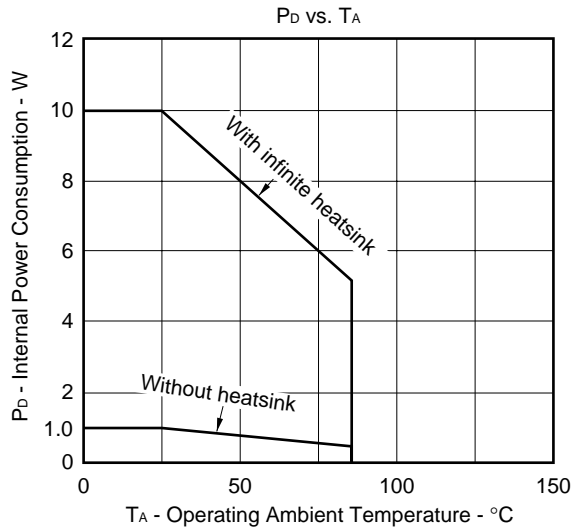

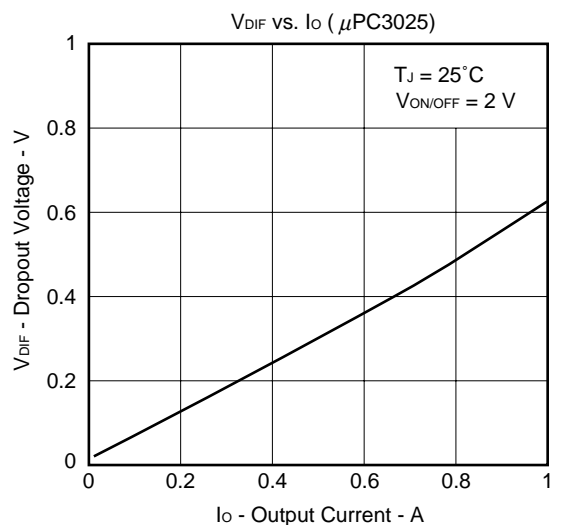
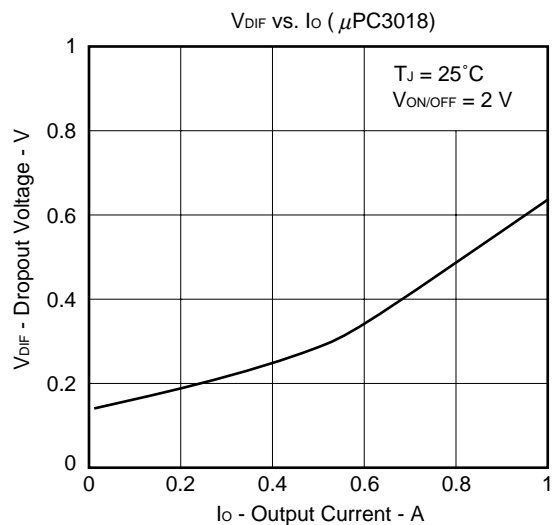
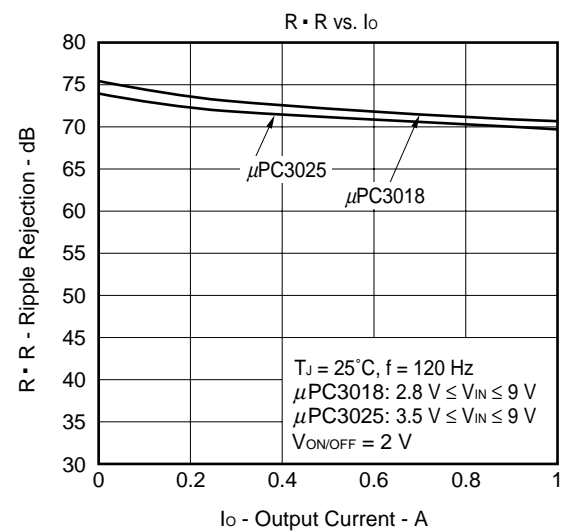
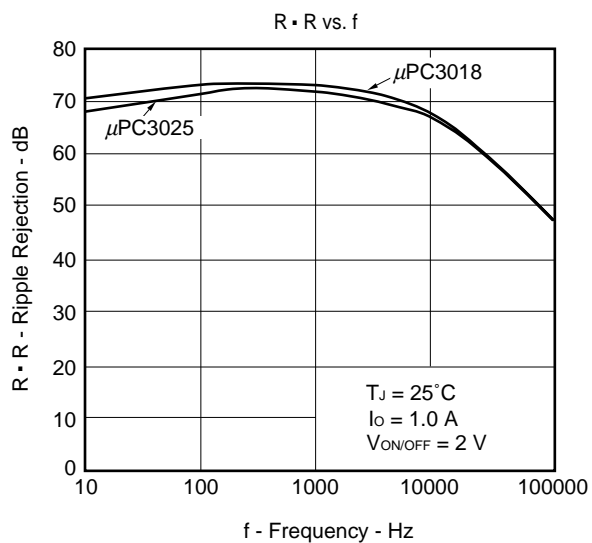
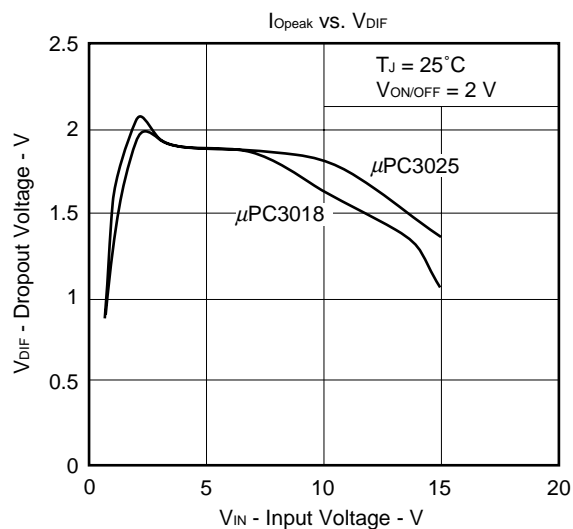
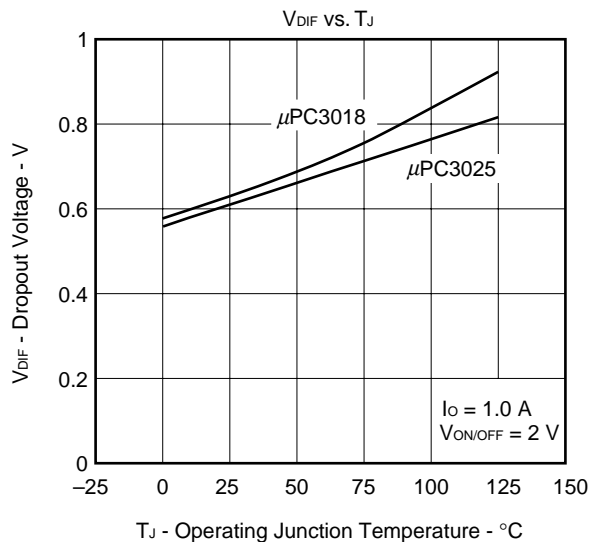

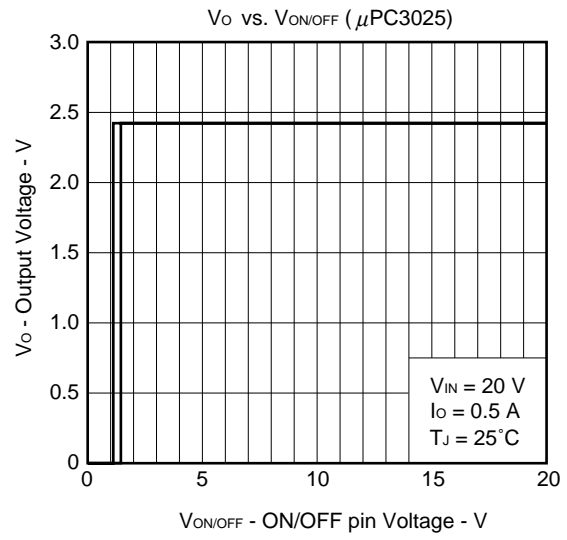
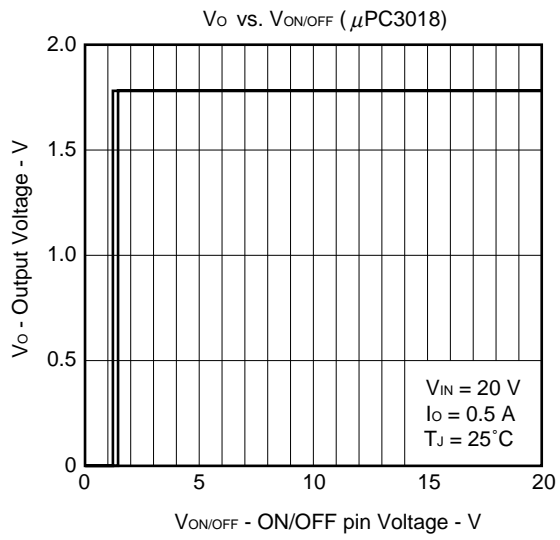





**RECOMMENDED SOLDERING CONDITIONS**

The μPC3018, 3025 should be soldered and mounted under the following recommended conditions.

For the details of the recommended soldering conditions, refer to the document **Semiconductor Device Mounting Technology Manual (C10535E)**.

For soldering methods and conditions other than those recommended below, contact our sales representative.

**Type of Surface Mount Device**

**μPC3018TJ, μPC3025TJ: MP-3Z (5 pin)**

Process	Conditions	Symbol
Infrared Ray Reflow	Peak temperature: 235°C, Reflow time: 30 seconds or less (at 210°C or higher), Maximum number of reflow processes: 3 times or less.	IR35-00-3
Vapor Phase Soldering	Peak temperature: 215°C, Reflow time: 40 seconds or less (at 200°C or higher), Maximum number of reflow processes: 3 times or less.	VP15-00-3
Wave Soldering	Solder temperature: 260°C or below, Flow time: 10 seconds or less, Maximum number of flow processes: 1 time, Pre-heating temperature: 120°C MAX. (Package surface temperature).	WS60-00-1
Partial Heating Method	Pin temperature: 300°C or below, Heat time: 3 seconds or less (Per each side of the device).	—

**Caution** Apply only one kind of soldering condition to a device, except for "partial heating method", or the device will be damaged by heat stress.

**Remark** It is recommended to use a rosin-type flux with a low chlorine element (chlorine: 0.2 Wt% or less).

**Type of Through-hole Device**

**μPC3018HB, μPC3025HB: MP-3 (5 pin)**

Process	Conditions
Wave Soldering (only to leads)	Solder temperature: 260°C or below, Flow time: 10 seconds or less
Partial Heating Method	Pin temperature: 300°C or below, Heat time: 3 seconds or less (Per each pin).

**Caution** For through-hole device, the wave soldering process must be applied only to leads, and make sure that the package body does not get jet soldered.

**CAUTION ON USE**

If the μPC3018 and μPC3025 Series are used with an input voltage that is lower than the recommended operating conditions, a large circuit current flows because the transistor in the output stage is saturated. The specification of this characteristic is the circuit operating current at startup, I<sub>BIAS (S)</sub>. In this product, the circuit current flowing at startup is limited by an on-chip inrush current protection circuit, but a circuit current of up to 80 mA may still flow. The power supply on the input side must therefore have sufficient capacitance to handle this circuit current at startup.

**REFERENCE DOCUMENTS**

Document Name	Document No.
Usage of Three-Terminal Regulators User's Manual	G12702E
Voltage Regulator of SMD Information	G11872E
Semiconductor Device Mounting Technology Manual Information	C10535E
SEMICONDUCTOR SELECTION GUIDE - Products and Packages-	X13769X

- **The information in this document is current as of July, 2002. The information is subject to change without notice. For actual design-in, refer to the latest publications of NEC's data sheets or data books, etc., for the most up-to-date specifications of NEC semiconductor products. Not all products and/or types are available in every country. Please check with an NEC sales representative for availability and additional information.**
  - No part of this document may be copied or reproduced in any form or by any means without prior written consent of NEC. NEC assumes no responsibility for any errors that may appear in this document.
  - NEC does not assume any liability for infringement of patents, copyrights or other intellectual property rights of third parties by or arising from the use of NEC semiconductor products listed in this document or any other liability arising from the use of such products. No license, express, implied or otherwise, is granted under any patents, copyrights or other intellectual property rights of NEC or others.
  - Descriptions of circuits, software and other related information in this document are provided for illustrative purposes in semiconductor product operation and application examples. The incorporation of these circuits, software and information in the design of customer's equipment shall be done under the full responsibility of customer. NEC assumes no responsibility for any losses incurred by customers or third parties arising from the use of these circuits, software and information.
  - While NEC endeavours to enhance the quality, reliability and safety of NEC semiconductor products, customers agree and acknowledge that the possibility of defects thereof cannot be eliminated entirely. To minimize risks of damage to property or injury (including death) to persons arising from defects in NEC semiconductor products, customers must incorporate sufficient safety measures in their design, such as redundancy, fire-containment, and anti-failure features.
  - NEC semiconductor products are classified into the following three quality grades:  
"Standard", "Special" and "Specific". The "Specific" quality grade applies only to semiconductor products developed based on a customer-designated "quality assurance program" for a specific application. The recommended applications of a semiconductor product depend on its quality grade, as indicated below. Customers must check the quality grade of each semiconductor product before using it in a particular application.  
"Standard": Computers, office equipment, communications equipment, test and measurement equipment, audio and visual equipment, home electronic appliances, machine tools, personal electronic equipment and industrial robots  
"Special": Transportation equipment (automobiles, trains, ships, etc.), traffic control systems, anti-disaster systems, anti-crime systems, safety equipment and medical equipment (not specifically designed for life support)  
"Specific": Aircraft, aerospace equipment, submersible repeaters, nuclear reactor control systems, life support systems and medical equipment for life support, etc.
- The quality grade of NEC semiconductor products is "Standard" unless otherwise expressly specified in NEC's data sheets or data books, etc. If customers wish to use NEC semiconductor products in applications not intended by NEC, they must contact an NEC sales representative in advance to determine NEC's willingness to support a given application.
- (Note)
- (1) "NEC" as used in this statement means NEC Corporation and also includes its majority-owned subsidiaries.
  - (2) "NEC semiconductor products" means any semiconductor product developed or manufactured by or for NEC (as defined above).