

QUAD Pch HIGH-SIDE SWITCH FOR USB

DESCRIPTION

The μ PD16874 is a power switch IC with an overcurrent limiter that is used for the power bus of a Universal Serial Bus (USB). This product has Pch power MOSFET circuits, each of which has a low-on resistance (100 m Ω TYP.), in its switching block.

In addition, the IC is also equipped with an overcurrent detector that is essential for a host/hub controller conforming to the USB Standard, so that the IC can report an overcurrent to the controller. Moreover, a thermal shutdown circuit and an undervoltage lockout circuit are also provided as the protection circuits of the IC.

This product has four channels of power switches, control input pins, and flag output pins to simultaneously control four USB ports with a single IC.

FEATURES

- Four P-ch power MOSFET circuits
- Overcurrent detector that outputs active-low control signal from detection report pin
- Overcurrent limiter to prevent system voltage drop
- Thermal shutdown circuit
- Undervoltage lockout circuit
- Each of four circuits can be turned on and off independently of the others by a control pin. (CTL input: active low)
- 16-pin SOP package

ORDERING INFORMATION

Part Number	Package
μ PD16874GS	16-pin SOP (7.62 mm (300))

The information in this document is subject to change without notice. Before using this document, please confirm that this is the latest version.
Not all devices/types available in every country. Please check with local NEC representative for availability and additional information.

BLOCK DIAGRAM

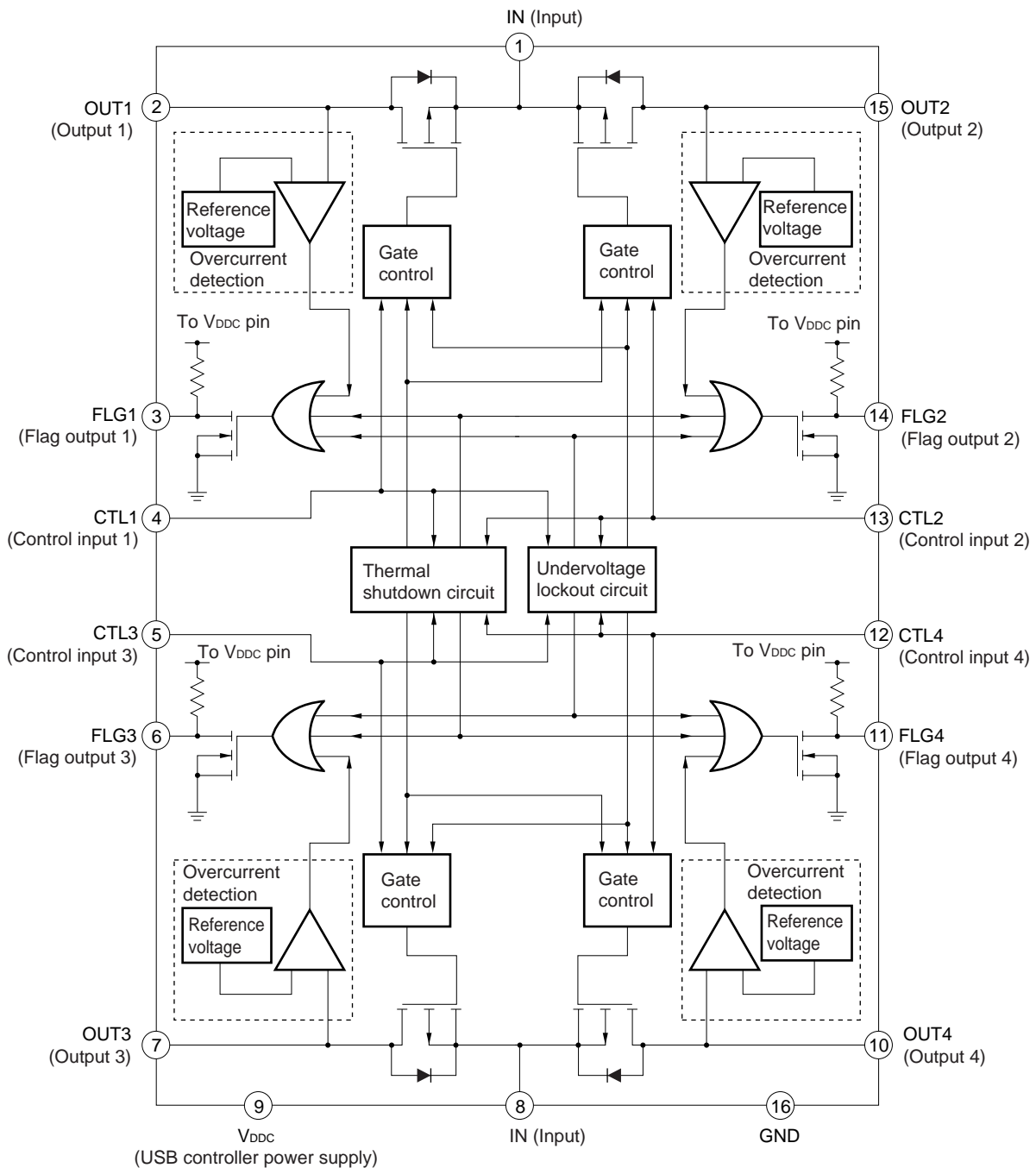

NOTES ON CORRECT USE

- No internal resistor is connected to input pins CTL1 (pin 4), CTL2 (pin 13), CTL3 (pin 5), and CTL4 (pin 12). When using the μPD16874, therefore, be sure to set the voltage level of these input pins to “H” or “L”.
- Keep the IN pins (pins 1 and 8) at the same potential.
- Supply a voltage lower than that supplied to the IN pins (pins 1 and 8) to V_{DDC} (pin 9).
- FLG1 (pin 3), FLG2 (pin 14), FLG3 (pin 6), and FLG4 (pin 11) are internally pulled up to V_{DDC} (USB controller supply voltage) (resistance: approx. 400 kΩ). Therefore, no external pull-up resistor has to be connected to these pins.

PIN CONFIGURATION (Top View)

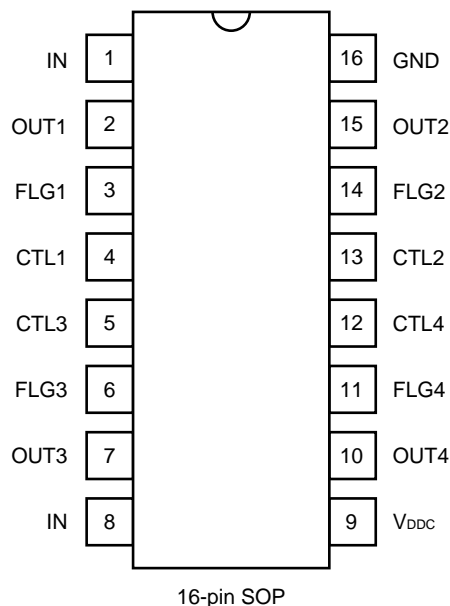

PIN DESCRIPTION

Pin No.	Pin Name	Pin Function
4/5/12/13	CTL1/CTL2/CTL3/CTL4	Control input (See the truth table below). TTL input
3/6/11/14	FLG1/FLG2/FLG3/FLG4	Detection flag (output): Active-low, Nch open-drain
16	GND	Ground
1/8	IN	Power input: Source of MOSFET for output. Power supply to internal circuitry of IC
9	V _{DDC}	USB controller power supply. Each FLG output is connected via internal resistor.
2/7/10/15	OUT1/OUT2/OUT3/OUT4	Switch output: Drain of MOSFET for output. Usually, connected to load.

TRUTH TABLE (H: High level, L: Low level, ON: Output on, OFF: Output off, X: H or L)

CTLn (In)	FLGn (Out)	OUTn (Out)	Operation mode
L	H	ON	OUTn ON
H	H	OFF	OUTn OFF
H (all)	H (all)	OFF (all)	Standby mode
L	L	ON	OUTn overcurrent detection
X	L (all)	OFF (all)	Thermal shutdown circuit operation
X	L (all)	OFF (all)	Undervoltage lockout circuit operation

ABSOLUTE MAXIMUM RATINGS (Unless otherwise specified, T_A = 25°C)

Parameter	Symbol	Conditions	Ratings	Unit
Input voltage	V _{IN}		-0.3 to +6	V
Flag voltage	V _{FLG}		-0.3 to +6	V
Flag current	I _{FLG}		50	mA
Output voltage	V _{OUT}		V _{IN} +0.3	V
Output current	I _{OUT}	DC	+0.5 (V _{IN} = V _{CTL} = 5 V) -0.1 (V _{IN} = 0 V, V _{OUT} = 5 V)	A
		Pulse width ≤ Single 100 μs pulse	+3	
Control input	V _{CTL}		-0.3 to +6	V
Total power dissipation ^{Note 1}	P _D		900	mW
Operating temperature range	T _A		-40 to +85	°C
Junction temperature ^{Note 2}	T _{CH MAX}		+150	°C
Storage temperature	T _{stg}		-55 to +150	°C

- Notes**
1. When mounted on a glass epoxy board measuring 90 mm × 90 mm × 1.6 mm thick
 2. This product has an internal thermal shutdown circuit (operating temperature: 150°C or higher TYP.)

RECOMMENDED OPERATING RANGE (Unless otherwise specified, T_A = 25°C)

Parameter	Symbol	MIN.	TYP.	MAX.	Unit
Input voltage	V _{IN}	+4		+5.5	V
Operating temperature range	T _A	0		+70	°C

ELECTRICAL SPECIFICATIONS

DC Characteristics (Unless otherwise specified, V_{IN} = +5 V, T_A = +25°C)

Parameter	Symbol	Conditions	MIN.	TYP.	MAX.	Unit
Current consumption	I _{DD}	V _{CTL} = V _{IN} (all CTL pins), OUT: Open		1	5	μA
		V _{CTL} = 0 V, OUT: open			150	μA
Input voltage, low	V _{IL}	CTL pin			1.0	V
Input voltage, high	V _{IH}	CTL pin	2.0			V
Control input current	I _{CTL}	V _{CTL} = 0 V		0.01	1	μA
		V _{CTL} = V _{IN}		0.01	1	μA
Output MOSFET on-resistance	R _{ON}	T _A = 0 to +70°C, I _{OUT} = 500 mA		100	140	mΩ
Output leakage current	I _{O LEAK}				10	μA
Overcurrent detector threshold	I _{TH}	T _A = 0 to +70°C	0.6	0.9	1.25	A
Flag output resistance	R _{ON F}	I _L = 10 mA		10	25	Ω
Flag leakage current	I _{O LEAK F}	V _{FLAG} = 5 V		0.01	1	μA
Undervoltage lockout circuit operating voltage	V _{UVLO}	V _{IN} : When rising	2.2	2.5	2.8	V
		V _{IN} : When falling	2.0	2.3	2.6	V
		Hysteresis width	0.05		0.25	V

ELECTRICAL SPECIFICATIONS

AC Characteristics (Unless otherwise specified, $V_{IN} = +5\text{ V}$, $T_A = +25^\circ\text{C}$)

Parameter	Symbol	Conditions	MIN.	TYP.	MAX.	Unit
Output transition rise time (ON)	t_{RISE}	$R_L = 10\ \Omega$ per output	2.5	5	8	ms
Output transition fall time (OFF)	t_{FALL}	$R_L = 10\ \Omega$ per output			10	μs
Overcurrent detection delay time	t_{OVER}			20		μs
Overcurrent detection output rise time	t_{SRISE}	$R_L = 10\ \Omega$ per output	2.5	5	8	ms
Minimum CTL high time	t_{CTL}	CTL : L→H→L	20			μs

POINTS OF MEASUREMENT

Output Transition Rise Time (ON)/Output Transition Fall Time (OFF)

CTL pin: H→L/L→H

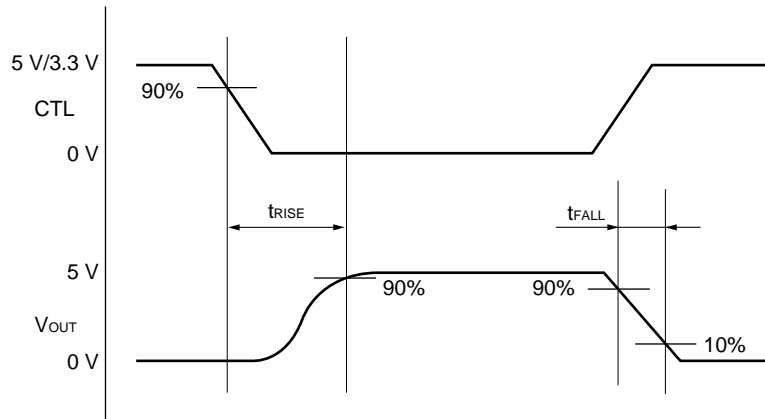

Overcurrent Detection Delay Time/Minimum CTL High Time

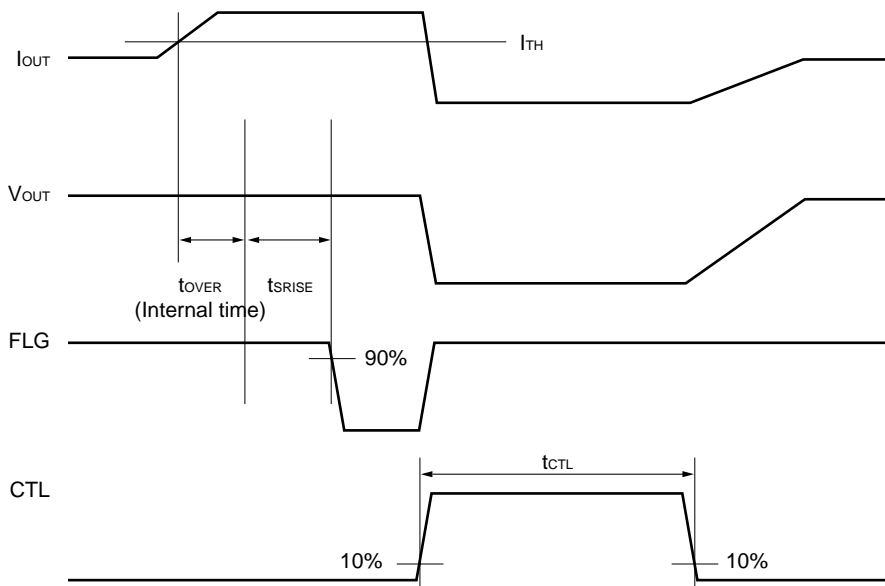

DESCRIPTION OF FUNCTIONS

1. Overcurrent Detection

This IC detects an overcurrent in a range of 0.6 to 1.25 A (0.9 A TYP.) (the USB Standard defines that an overcurrent is 0.5 A MAX.). When the IC detects an overcurrent, the FLG pin goes low (active) and reports the result of detection to the control IC. At this time, the switch is kept ON and the current limiter is activated. In this way, an overcurrent status that lasts for a long time can be prevented.

By deasserted the CTL pin inactive by the control IC, the switch is turned OFF and the FLG pin goes back high. Therefore, the CTL signal must be deasserted inactive as soon as the controller IC has detected that the FLG pin has gone low, to avoid overheating this IC. Once the switch has been turned OFF, it turns back ON again only when the CTL signal is asserted active while the FLG pin is high.

To prevent an inrush current being detected by mistake, a deadband time (overcurrent detection delay time) is set to elapse before the overcurrent detector is activated. The duration of this deadband time is 20 μs TYP.

While the overcurrent limiter is activated, the power consumption of the device may abruptly increase. As a result, the junction temperature may also rise. Make sure that the CTL signal is deasserted inactive and that the switch is turned OFF before the absolute maximum rating is exceeded.

2. Undervoltage Lockout Circuit (UVLO)

This circuit prevents malfunctioning of the switch due to fluctuation in supply voltage.

When power is turned on (2.5 V or less TYP.) or off (2.3 V or less TYP.), the OUT and FLG pins have the following status:

- OUT: OFF
- FLG: "L" (= 0 V)

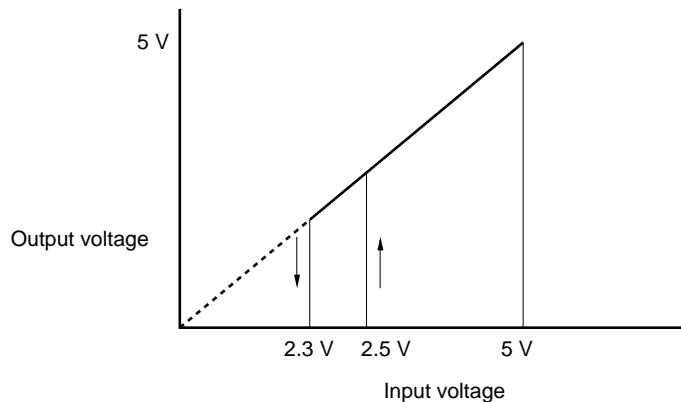

The above figure does not show the actual waveform. For the related characteristic waveform, refer to Major Characteristic Curves.

3. Behavior When Power is Turned ON/OFF

This IC performs a soft-start operation on power application. This is to prevent an overcurrent from flowing through the IC on power application while the high-capacity capacitor connected to the output pin is charged.

Power ON: Soft start (2.5 to 8 ms)

Power OFF: No control (10 μ s MAX.)

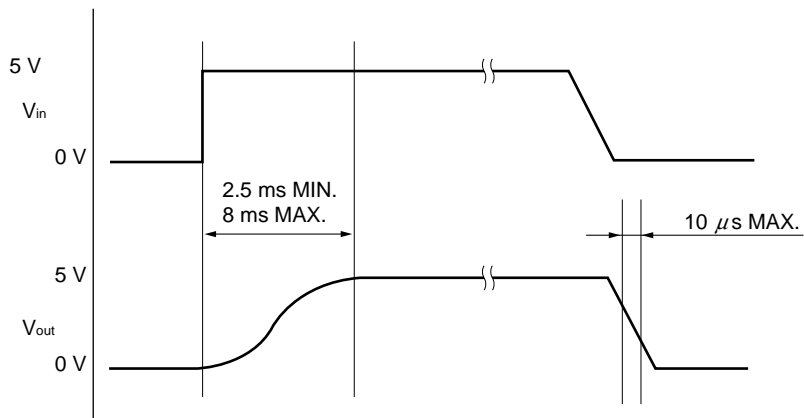

The above figure does not show the actual waveform. For the related characteristic waveform, refer to Major Characteristic Curves.

OPERATION SEQUENCE

Power ON/OFF

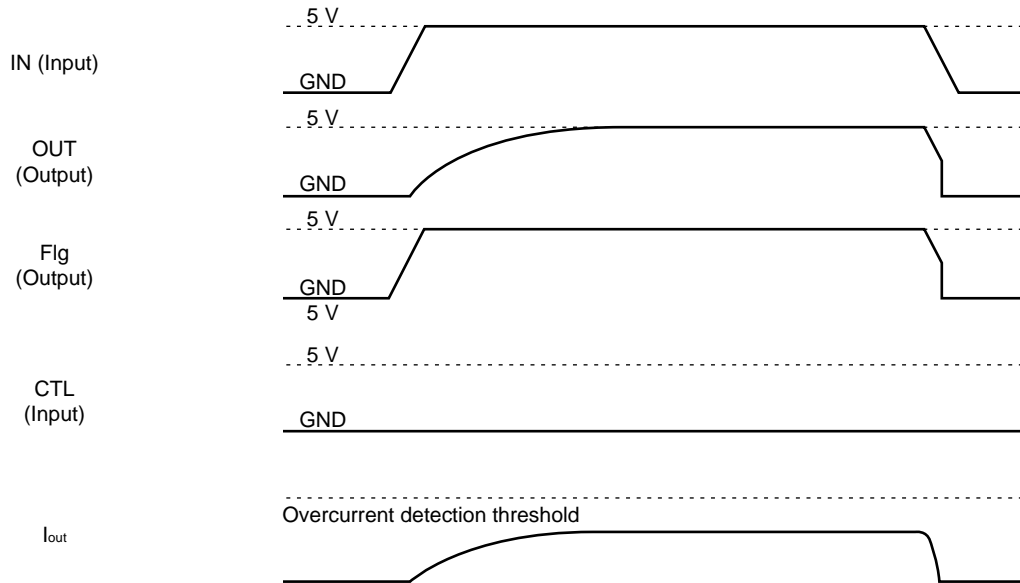

Note If the CTL signal is asserted active after power has been turned ON, OUT executes the soft-start operation (output transition time: 8 ms MAX.). In addition, FLG output is fixed to “L” if the supply voltage is lower than the operating voltage of the undervoltage lockout circuit (UVLO) on power application. If all the CTL pins are inactive when power is supplied, the IC enters the standby status (IDD = 5 μA MAX.).

When Control Signals Are Input

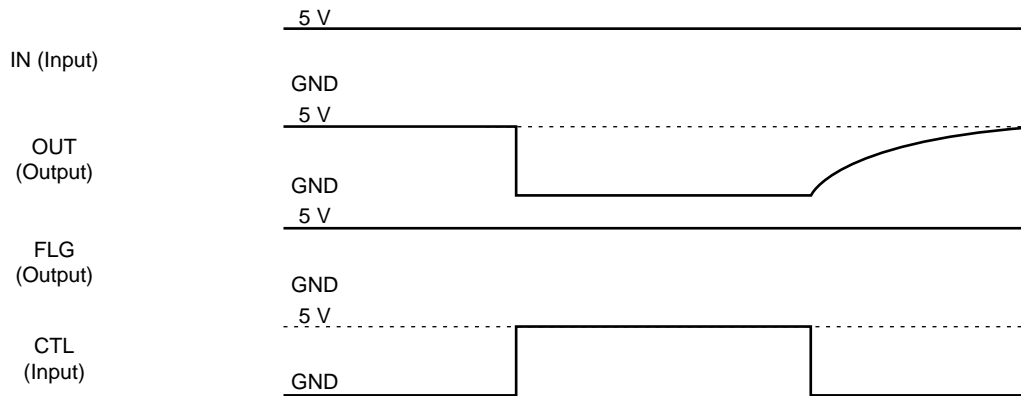

On Detection of Overcurrent

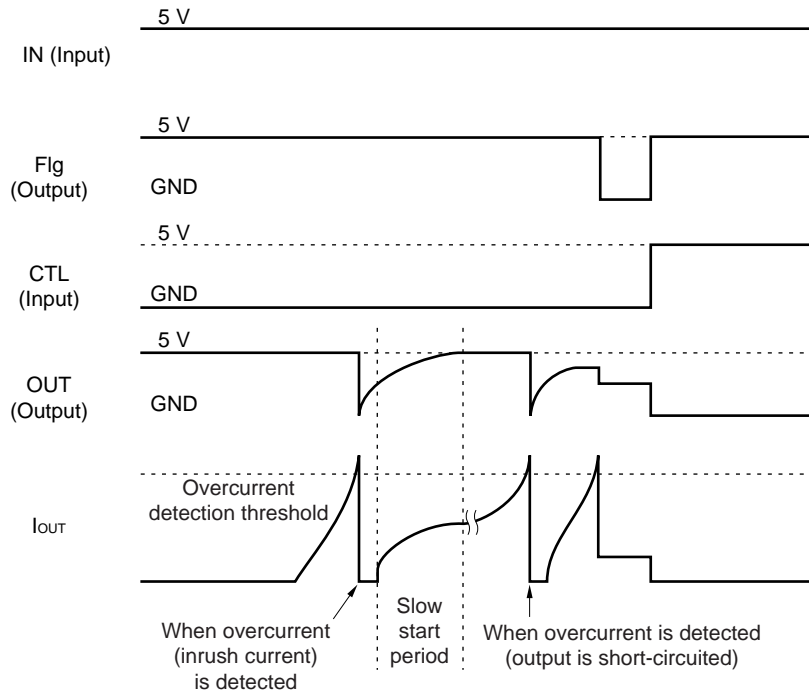

If an overcurrent is detected after the overcurrent detection delay time of 20 μs, the IC executes a slow-start operation again.

If an overcurrent is detected while the IC is executing the slow-start operation again, it is assumed that the output is short-circuited and the FLG pin goes low. When the CTL signal is deasserted inactive, OUT is turned OFF and FLG goes high. If the CTL signal is asserted active, OUT is turned back ON unless the undervoltage lockout circuit or thermal shutdown circuit is activated.

When Thermal Shutdown Circuit Operates

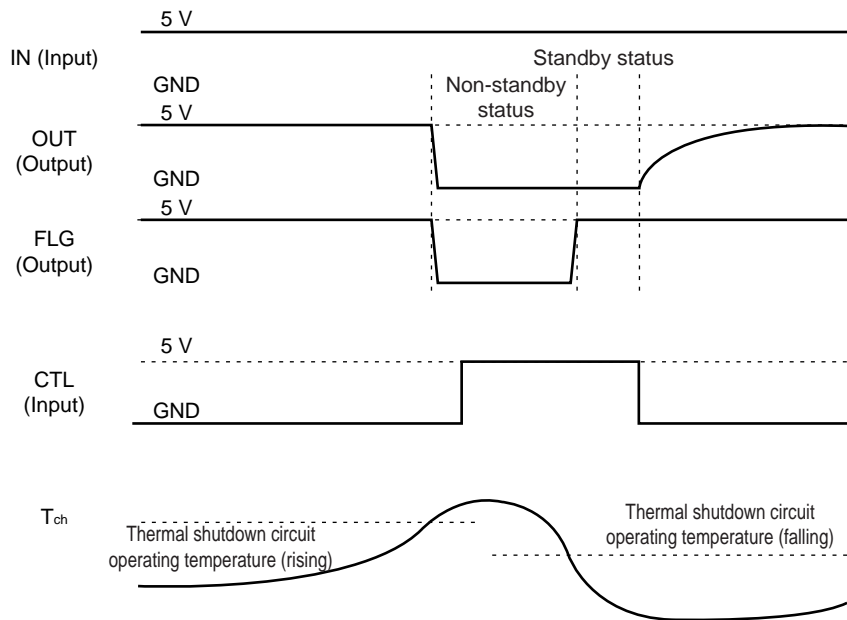

While the thermal shutdown circuit is activated, the output pins are in the OFF status. However, the IC does not enter the standby status even if all the CLT pins are deasserted inactive at the same time.

The thermal shutdown circuit is not activated even if the junction temperature exceeds 150°C TYP. while the IC is in the standby mode (when all the CTL pins are inactive).

TEST CIRCUIT

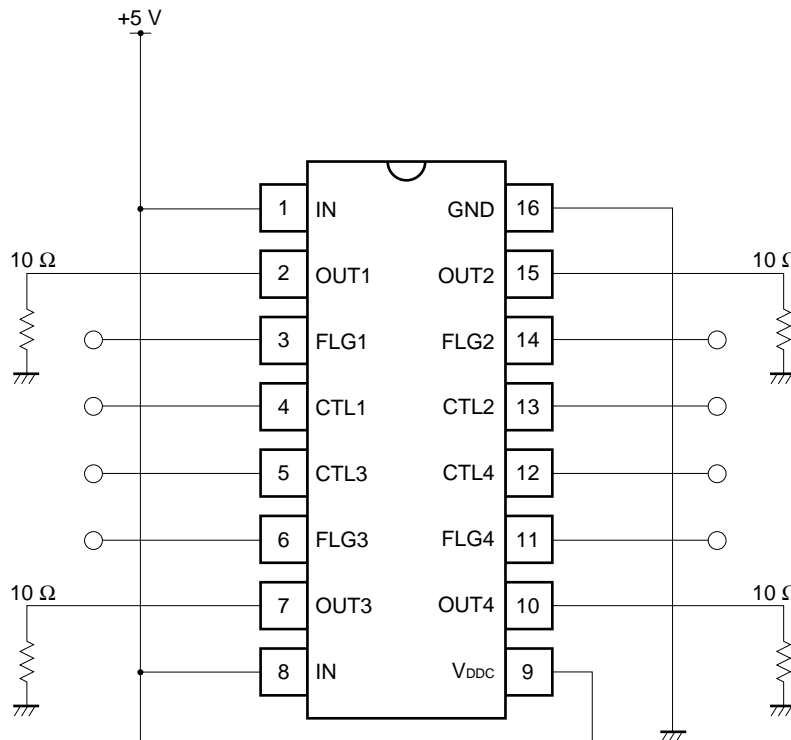

MAJOR CHARACTERISTIC CURVES (Unless otherwise specified, $T_A = +25^\circ\text{C}$, $V_{IN} = +5\text{ V}$)

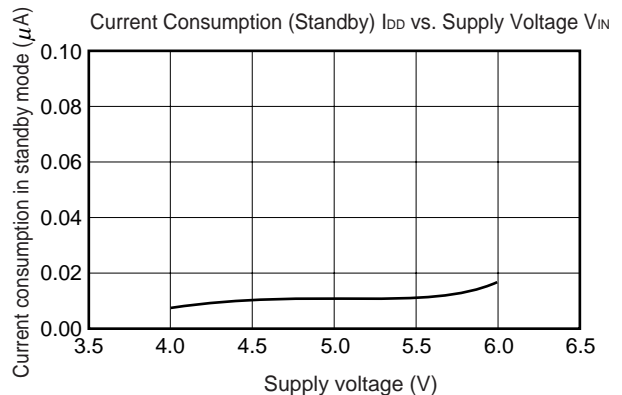
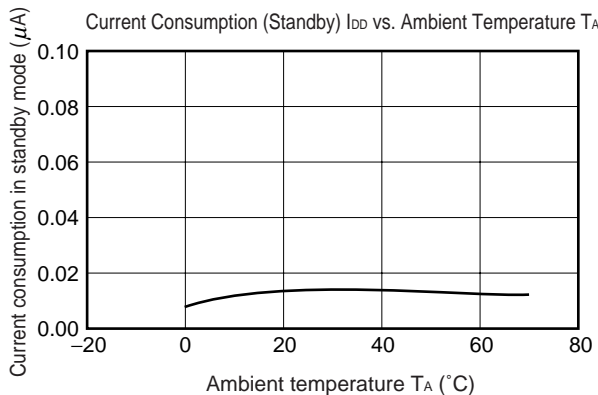
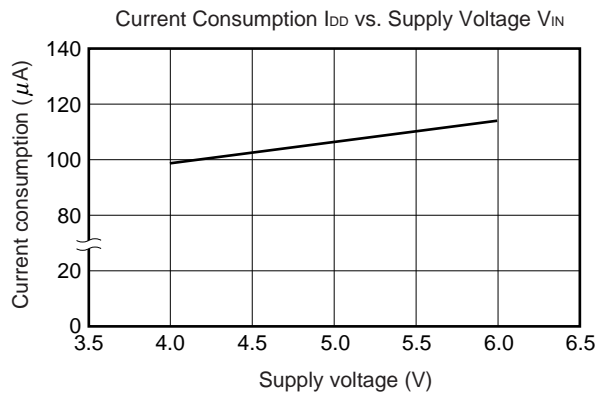
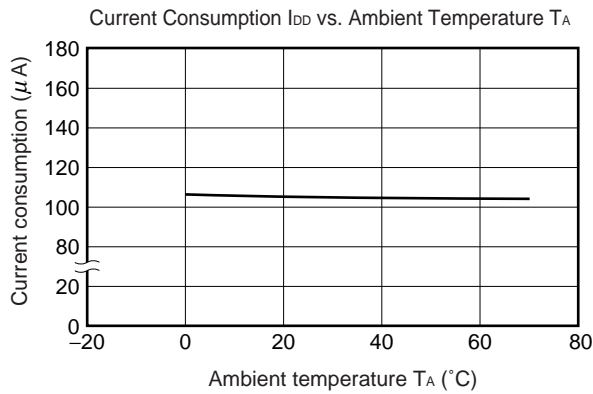
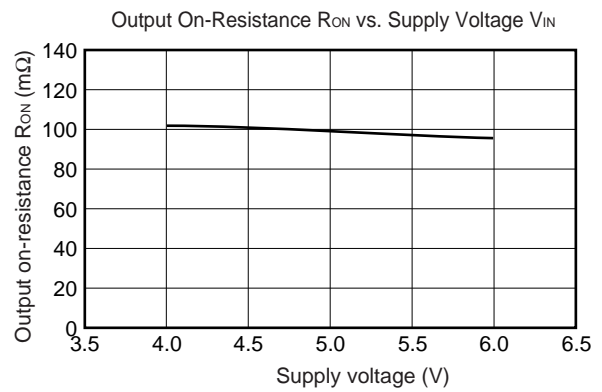
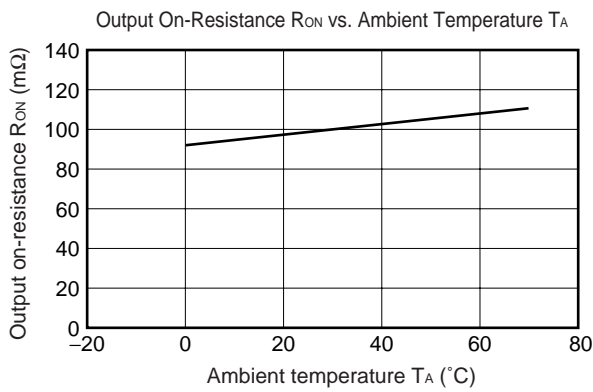
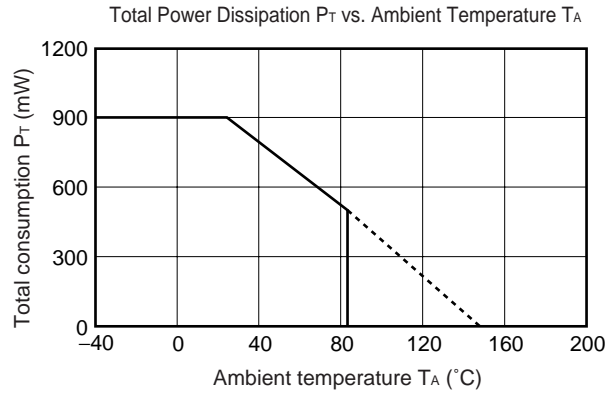

MAJOR CHARACTERISTIC CURVES (Unless otherwise specified, $T_A = +25^\circ\text{C}$, $V_{IN} = +5\text{ V}$)

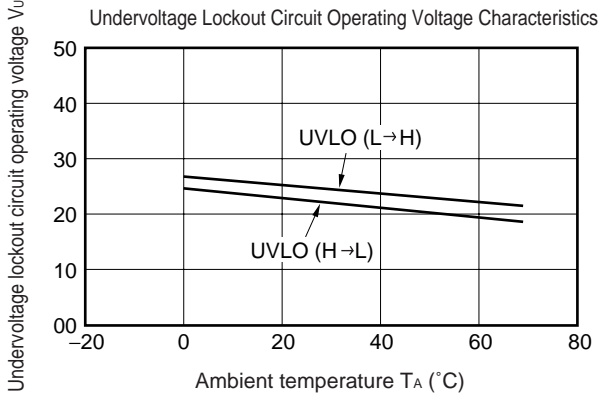
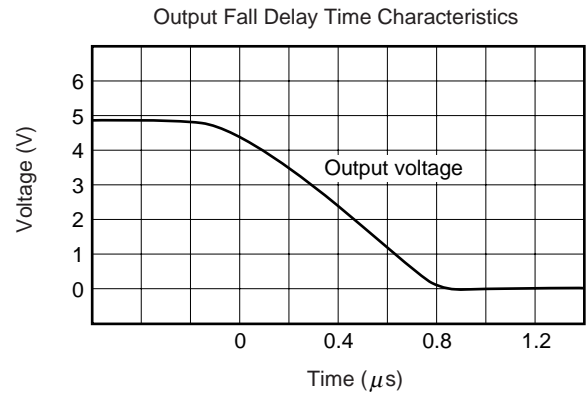
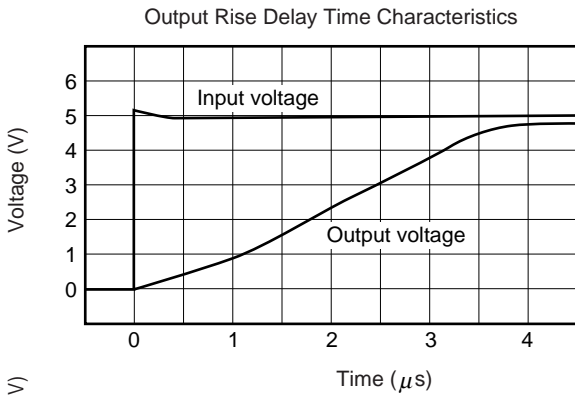
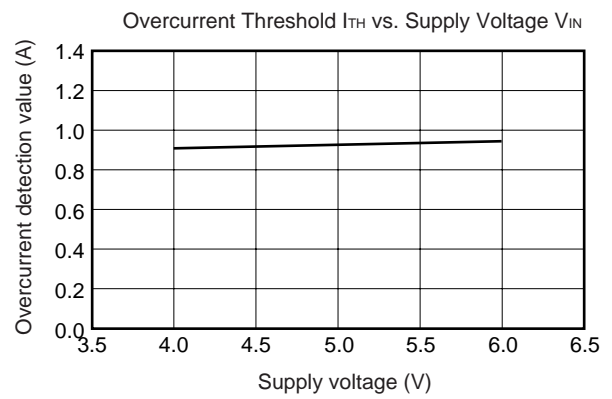
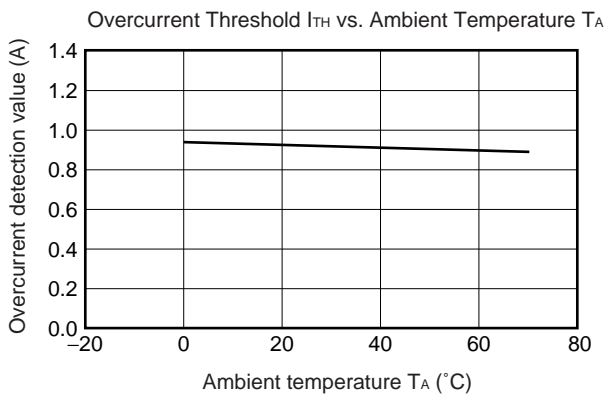
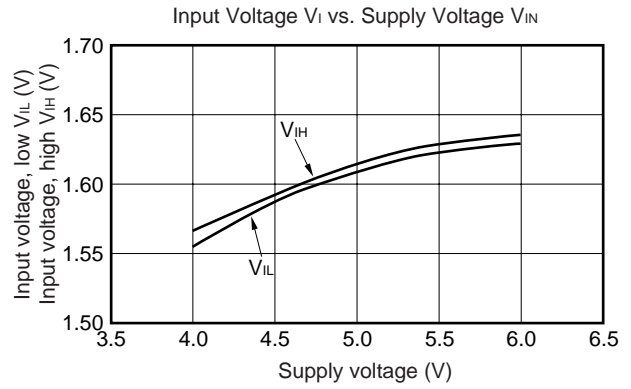
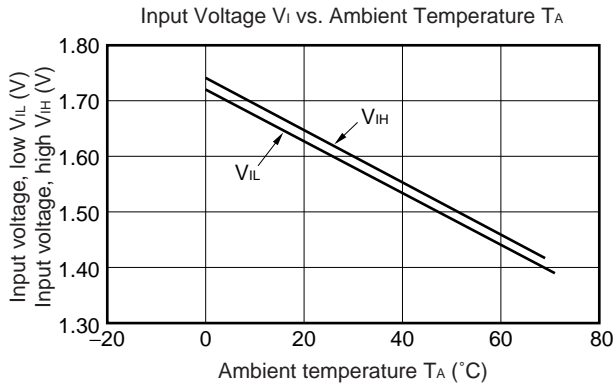

APPLICATION CIRCUIT

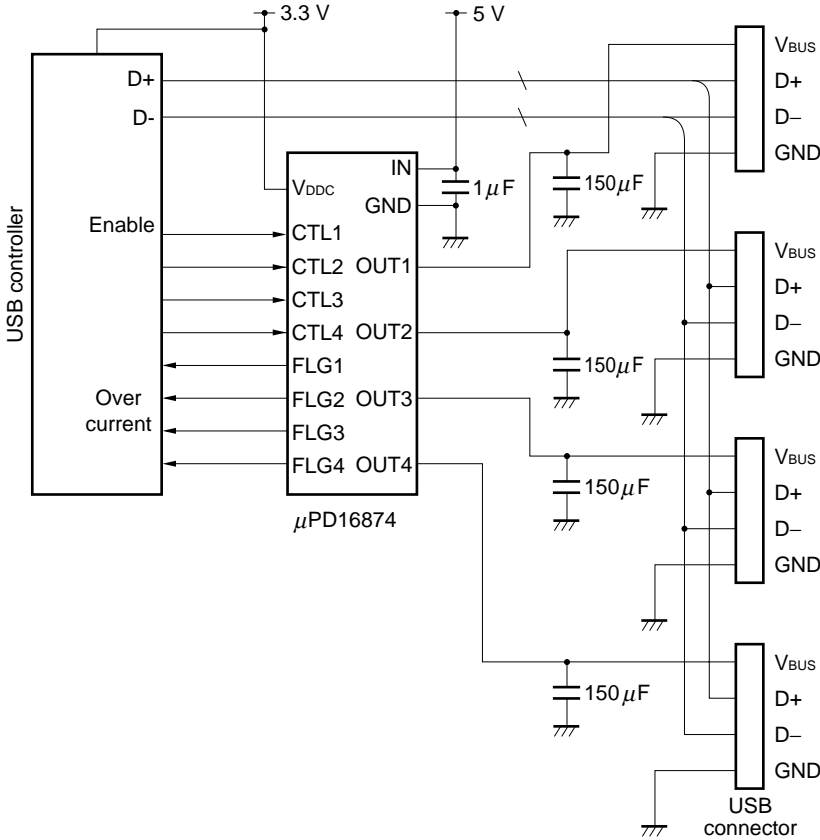

PACKAGE DRAWING

16-PIN PLASTIC SOP (7.62 mm (300))

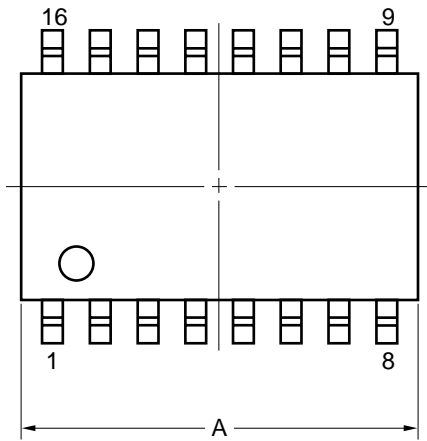

detail of lead end

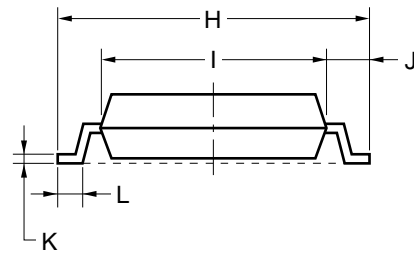
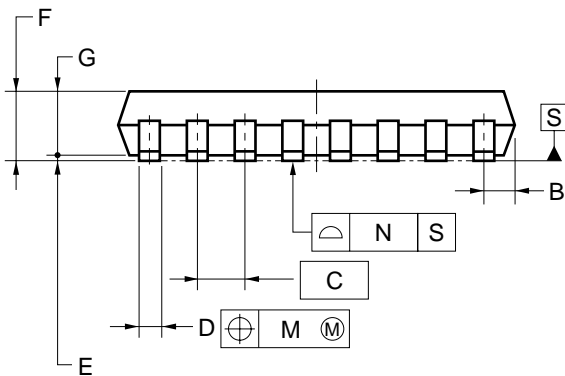
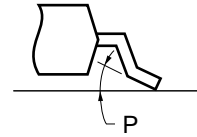

NOTE

Each lead centerline is located within 0.12 mm of its true position (T.P.) at maximum material condition.

ITEM	MILLIMETERS
A	10.2±0.2
B	0.78 MAX.
C	1.27 (T.P.)
D	0.42 ^{+0.08} _{-0.07}
E	0.1±0.1
F	1.65±0.15
G	1.55
H	7.7±0.3
I	5.6±0.2
J	1.1±0.2
K	0.22 ^{+0.08} _{-0.07}
L	0.6±0.2
M	0.12
N	0.10
P	3° ^{+7°} _{-3°}

P16GM-50-300B-6

RECOMMENDED SOLDERING CONDITIONS

The μPD16874 should be soldered and mounted under the following recommended conditions.
 For soldering methods and conditions other than those recommended, contact your NEC sales representative.

Surface Mount Type

For the details of the recommended soldering conditions, refer to the document **Semiconductor Device Mounting Technology Manual (C10535E)**.

μPD16874GS

Soldering Method	Soldering Conditions	Recommended Condition Symbol
Infrared reflow	Package peak temperature: 235°C, Time: 30 sec. Max. (at 210°C or higher), Count: two times, Exposure limit: Not limited ^{Note}	IR35-00-2
VPS	Package peak temperature: 215°C, Time: 40 sec. Max. (at 200°C or higher), Count: two times, Exposure limit: Not limited ^{Note}	VP15-00-2
Wave soldering	Solder bath temperature: 260°C Max., Time: 10 sec. Max., Count: once, Exposure limit: not limited ^{Note}	WS60-00-1
Partial heating	Pin temperature: 300°C Max., Time: 3 sec. Max., Exposure limit: not limited ^{Note}	—

Note After opening the dry pack, store it at 25°C or less and 65% RH or less for the allowable storage period.

Cautions Do not use different soldering methods together (except for partial heating).

REFERENCE

Quality Grades on NEC semiconductor Devices	C11531E
Semiconductor Device Mounting Technology Manual	C10535E
NEC Semiconductor Device Reliability/Quality Control System	C10983E
Semiconductor Selection Guide	X10679X

[MEMO]

[MEMO]

NOTES FOR CMOS DEVICES**① PRECAUTION AGAINST ESD FOR SEMICONDUCTORS**

Note:

Strong electric field, when exposed to a MOS device, can cause destruction of the gate oxide and ultimately degrade the device operation. Steps must be taken to stop generation of static electricity as much as possible, and quickly dissipate it once, when it has occurred. Environmental control must be adequate. When it is dry, humidifier should be used. It is recommended to avoid using insulators that easily build static electricity. Semiconductor devices must be stored and transported in an anti-static container, static shielding bag or conductive material. All test and measurement tools including work bench and floor should be grounded. The operator should be grounded using wrist strap. Semiconductor devices must not be touched with bare hands. Similar precautions need to be taken for PW boards with semiconductor devices on it.

② HANDLING OF UNUSED INPUT PINS FOR CMOS

Note:

No connection for CMOS device inputs can be cause of malfunction. If no connection is provided to the input pins, it is possible that an internal input level may be generated due to noise, etc., hence causing malfunction. CMOS devices behave differently than Bipolar or NMOS devices. Input levels of CMOS devices must be fixed high or low by using a pull-up or pull-down circuitry. Each unused pin should be connected to V_{DD} or GND with a resistor, if it is considered to have a possibility of being an output pin. All handling related to the unused pins must be judged device by device and related specifications governing the devices.

③ STATUS BEFORE INITIALIZATION OF MOS DEVICES

Note:

Power-on does not necessarily define initial status of MOS device. Production process of MOS does not define the initial operation status of the device. Immediately after the power source is turned ON, the devices with reset function have not yet been initialized. Hence, power-on does not guarantee out-pin levels, I/O settings or contents of registers. Device is not initialized until the reset signal is received. Reset operation must be executed immediately after power-on for devices having reset function.

Regional Information

Some information contained in this document may vary from country to country. Before using any NEC product in your application, please contact the NEC office in your country to obtain a list of authorized representatives and distributors. They will verify:

- Device availability
- Ordering information
- Product release schedule
- Availability of related technical literature
- Development environment specifications (for example, specifications for third-party tools and components, host computers, power plugs, AC supply voltages, and so forth)
- Network requirements

In addition, trademarks, registered trademarks, export restrictions, and other legal issues may also vary from country to country.

NEC Electronics Inc. (U.S.)

Santa Clara, California
Tel: 408-588-6000
800-366-9782
Fax: 408-588-6130
800-729-9288

NEC Electronics (Germany) GmbH

Duesseldorf, Germany
Tel: 0211-65 03 02
Fax: 0211-65 03 490

NEC Electronics (UK) Ltd.

Milton Keynes, UK
Tel: 01908-691-133
Fax: 01908-670-290

NEC Electronics Italiana s.r.l.

Milano, Italy
Tel: 02-66 75 41
Fax: 02-66 75 42 99

NEC Electronics (Germany) GmbH

Benelux Office
Eindhoven, The Netherlands
Tel: 040-2445845
Fax: 040-2444580

NEC Electronics (France) S.A.

Velizy-Villacoublay, France
Tel: 01-30-67 58 00
Fax: 01-30-67 58 99

NEC Electronics (France) S.A.

Madrid Office
Madrid, Spain
Tel: 91-504-2787
Fax: 91-504-2860

NEC Electronics (Germany) GmbH

Scandinavia Office
Taeby, Sweden
Tel: 08-63 80 820
Fax: 08-63 80 388

NEC Electronics Hong Kong Ltd.

Hong Kong
Tel: 2886-9318
Fax: 2886-9022/9044

NEC Electronics Hong Kong Ltd.

Seoul Branch
Seoul, Korea
Tel: 02-528-0303
Fax: 02-528-4411

NEC Electronics Singapore Pte. Ltd.

United Square, Singapore
Tel: 65-253-8311
Fax: 65-250-3583

NEC Electronics Taiwan Ltd.

Taipei, Taiwan
Tel: 02-2719-2377
Fax: 02-2719-5951

NEC do Brasil S.A.

Electron Devices Division
Guarulhos-SP Brasil
Tel: 55-11-6462-6810
Fax: 55-11-6462-6829

J00.7