

VKQ100MS05

100 Watt, 5.0Vout, Quarter Brick DC/DC Converter

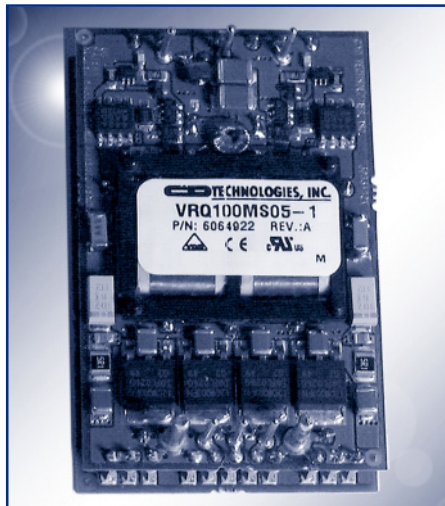

FEATURES

- 36 - 75V Input Range
- Small Size: 1.5" x 2.3" x .50"
- High Efficiency: $\geq 86\%$
- Fixed Frequency Operation 480kHz
- Primary Remote On/Off
- Adjustable Output Voltage
- Brick Wall Current Limiting
- On Board Input Differential Filter
- No Minimum Load Requirement
- Remote Sense

- No Heatsink Required
- No External Components Required
- Safety per UL/CUL 60950, EN 60950, Operational Insulation Meets TNV-SELV Isolation Requirements

APPLICATIONS

- Distributed Power Architectures
- Telecommunications
- Battery Powered Systems
- Workstations

The VKQ100MS05 DC/DC converter presents an economical and practical solution for distributed power system architectures which require high power density and efficiency while maintaining system modularity and upgradeability. With the ability to operate over a wide input voltage range of 36 to 75 Vdc, this module is ideal for telecommunications and battery backup applications where

input flexibility must be combined with output voltage regulation. In addition, the output is fully isolated from the input, allowing for a variety of polarity and grounding configurations.

Innovative circuit design using surface mount components results in a compact, efficient and reliable solution to DC/DC conversion needs. Internal power dissipation is minimized by the

VKQ100MS05's high efficiency and is aided by a metal baseplate to which all heat dissipative elements are coupled.

The control circuitry of the VKQ100MS05 has been designed to provide overvoltage protection as well as current limiting for continuous short-circuit protection.

PRODUCT SELECTION CHART

MODEL	NOMINAL INPUT VOLTAGE (VDC)	RATED OUTPUT VOLTAGE (VDC)	RATED OUTPUT CURRENT (A)	INPUT CURRENT NOM (A)	EFFICIENCY	
					MIN (%)	TYP (%)
VKQ100MS05	48	5.0	20	2.40	86	86.5

ORDERING INFORMATION

MODEL NO.	PART NO.
VKQ100MS05	6064922

ABSOLUTE MAX. RATINGS

Output Short-Circuit Duration	Continuous
Internal Power Dissipation	16.3 Watts
Lead Temperature (soldering, 10 seconds max)	+300°C
Continuous Input Voltage	75 VDC
Storage Temperature	+125°C
Input to Output Isolation	1500 VDC
Input Voltage (non-operating)	100 VDC

SPECIFICATIONS

Unless otherwise specified, all specifications are at $T_A = +25^\circ\text{C}$.

	PARAMETER	CONDITIONS	MIN	NOM	MAX	UNITS
INPUT	Voltage Range (Vin)		36	48	75	Vdc
	Reflected Ripple Current ₁	Vin = 48 Vdc; Io = 20 A.			4	A pk-pk
	Input Ripple Rejection (100 Hz – 1KHz)	Vin = 48 Vdc; Io = 20 A.	-30			dB
	No Load Input Current	Vin = 48 Vdc; Io = 0 A.		90	100	mA
	Quiescent Input Current Primary On/Off Disabled	Vin = 48 Vdc; Io = 20 A.			4	mA
	Power Dissipation No Load	Vin = 48 Vdc.		4.85	5.30	W
	Standby, Primary On/Off Disabled				0.20	W
	Maximum Input Current	Vin = 36 Vdc; Io = 20 A.			3.40	A
	Inrush Charge	Vin = 75 Vdc.			0.165	mC
	Input Under Voltage Protection	Tamb = -40°C to +60°C; Io = 0 A to 20 A				
	Shut down		31.50		32.50	Vdc
	Turn On		32.50		33.70	Vdc
	Input Over Voltage Protection	Tamb = -40°C to +60°C; Io = 0 A to 20 A				
	Shut down		76.50		79.00	Vdc
	Turn On		76.00		78.00	Vdc
	Input Under Voltage Protection Shutdown	Tamb = +25°C; Io = 0A to 20A	32.00		32.25	Vdc
	Turn On		33.00		33.50	Vdc
	Input Over Voltage Protection	Tamb = -40°C to +60°C; Io = 0 A to 20 A				
	Shut down		77.70		79.00	Vdc
	Turn On		76.20		77.60	Vdc
OUTPUT	OUTPUT					
	Nominal Voltage (Vnom)			5.00		Vdc
	Output Current (Io) ₂	Vin = 36 Vdc to 75 Vdc.	0		20	A
	Rated Power ₂	Vin = 36 Vdc to 75 Vdc.	0		100	W
	Set Point Accuracy	Vin = 48 Vdc; Io = 10 A; Tamb = -40°C to +60°C. Tamb = +25°C			1 0.50	% of Vnom % of Vnom
	Line Regulation	Vin = 36 Vdc to 75 Vdc; Tamb = -40°C to +60°C; Io = 20 A.		0.02	0.20	% of Vnom
		Tamb = +25°C		0.01	0.05	% of Vnom
	Load Regulation	Vin = 36 Vdc to 75 Vdc; Io = 0 A to 20 A.				
		Tamb = -40°C to +60°C;		0.15	0.30	% of Vnom
		Tamb = +25°C; Vin = 48Vdc		0.01	0.05	% of Vnom
	Ripple & Noise ₃	Vin = 36-75 Vdc; Io = 0-20 A; TA = -40°C to +60°C f < 20 MHz Bandwidth.			120	mV pk-pk
	Temperature Drift	Tamb = -40°C to +60°C; Vin = 48 Vdc; Io = 20 A.		0.005	0.01	%/°C
	Current Limit Inception	Vin = 48 Vdc.	21.50		24.00	A
	Short Circuit Current	Vin = 48 Vdc.	21.00		24.00	A
	Output Voltage Adjust Range	Vin = 48 Vdc; Io = 0-20 A	-10		+10	%Vnom
	Turn – On Time	Vin = 48 Vdc; Io = 0-20 A Output to within 1% of Vnom		1.00	1.40	ms
	Over Voltage Protection Set Point	Vin = 48 Vdc; Io = 20 A.	6.60		7.10	Vdc
	Transient Response	50% to 100% Load Step to di/dt = 75A/μS; Co = 1000μF; Vin = 48Vdc				
	Peak Deviation				210	mV
	Settling Time				70	μS
GENERAL	GENERAL					
	Efficiency ₄	Vin = 48 Vdc; Io = 20 A.	86			%
	Switching Frequency	Vin = 36 Vdc-75 Vdc; Io = 0-20 A	460	480	500	KHz
	Remote Sense Compensation	Vin = 48 Vdc			0.500	Vdc
	Remote On / Off Control Inputs	Vin = 36 Vdc-48 Vdc; Io = 0-20 A Tamb = -40°C to +60°C				
	Primary Sink Current – Logic Low		0.60		1.60	mA
	Vlow			0.70	0.75	Vdc
	Vhigh		N/A	N/A	N/A	Open Collector
	Calculated MTTF Per Telcordia TR-NWT-000332	Vin = 48 Vdc; Io = 20 A	TBD			Hours
	Per MIL-HDBK217E		TBD			Hours
Operating Ambient Temperature		-40		+70	°C	

SPECIFICATIONS Unless otherwise specified, all specifications are at $T_A = +25^\circ\text{C}$.

ISOLATION	PARAMETER	CONDITIONS	MIN	NOM	MAX	UNITS	
	ISOLATION						
	Input to Output		1500			Vdc	
	Input to Base Plate		1500			Vdc	
	Output to Base Plate		500			Vdc	
	Resistance	Input to Output	10			$M\Omega$	
	Capacitance	Input to Output		2000		pF	
Leakage Current	$V(\text{input} - \text{output}) = 240 \text{ Vac}, 60 \text{ Hz}$			180	$\mu\text{A}, \text{rms}$		

- Notes:**
1. A future Application Note will detail the technique used to measure the reflected ripple current.
 2. Refer to Power Derating Curve below for details on Output Current Derating with Ambient Temperature. A future Application Note will detail air flow characterization.
 3. Refer to performance curves section (pages 4 and 5) for variation in output ripple and noise with Ambient Temperature, Input Voltage and Output Current. The unit requires a ceramic capacitor of $0.022\mu\text{F}$ across measurement terminals. A future Application Note will detail measurement set up for output ripple and noise.
 4. Refer to performance curves section for variation in efficiency against Input Voltage, Ambient Temperature, Output Load and Frequency.

MECHANICAL

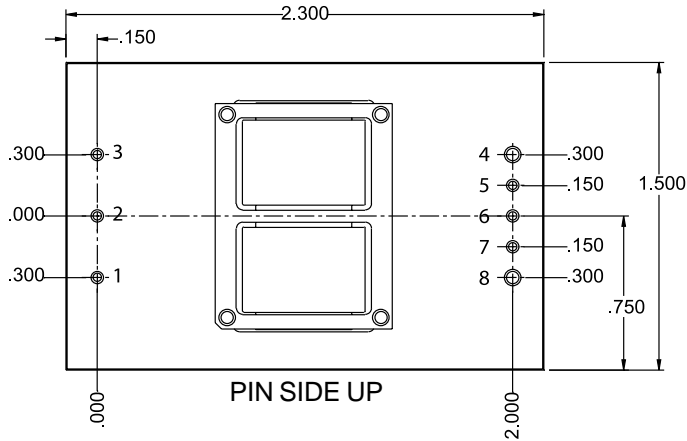

VKQ100MS05 (6064922)

PIN ASSIGNMENT

No.	Function
1	+Vin
2	On/Off
3	-Vin
4	-Vout
5	-Sense
6	Trim
7	+Sense
8	+Vout

NOTES:

General Tolerance: ± 0.20
 Pin Location Tolerance: ± 0.10
 Unit Weight: 34g / 1.2oz.
 PIN MATERIAL: COPPER
 PIN FINISH: TIN-LEAD

POWER DERATING CURVE ($V_{in} = 36\text{Vdc} - 75\text{Vdc}$)

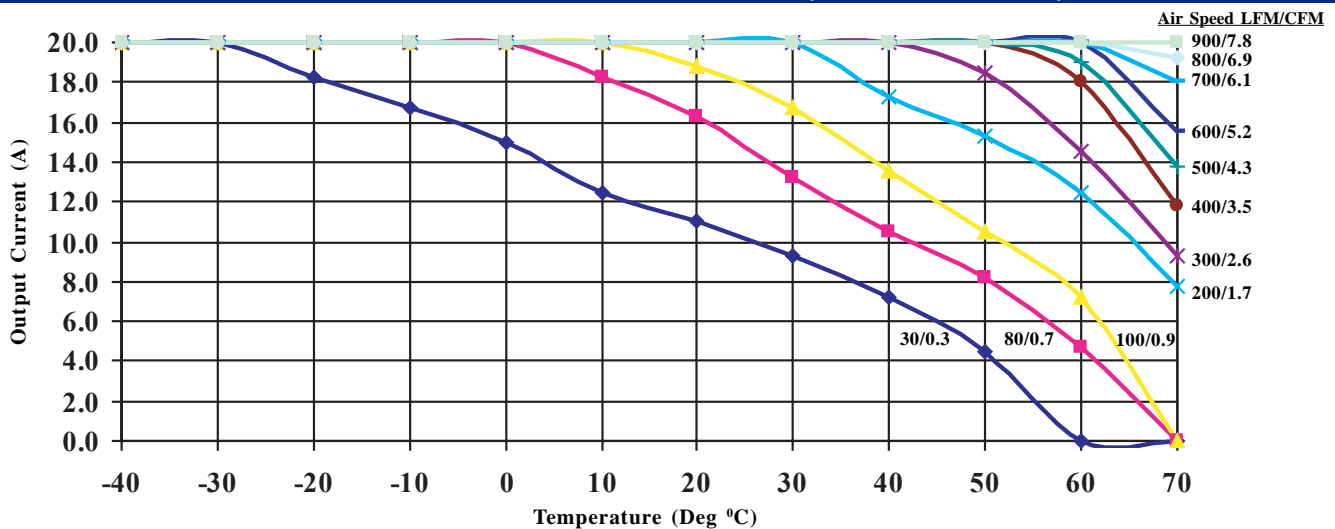

TYPICAL PERFORMANCE CURVES

EFFICIENCY (%) vs. OUTPUT CURRENT (A) @ $T_A +25^{\circ}\text{C}$; $V_{in} = 48\text{Vdc}$

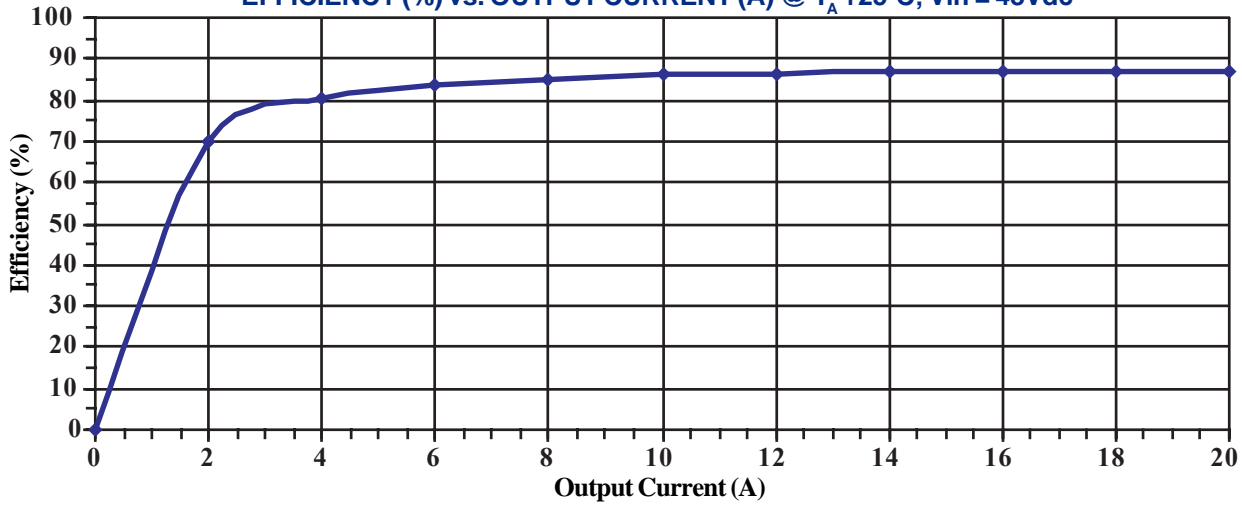

EFFICIENCY (%) vs. INPUT VOLTAGE @ $T_A +25^{\circ}\text{C}$; $I_o = 20\text{A}$

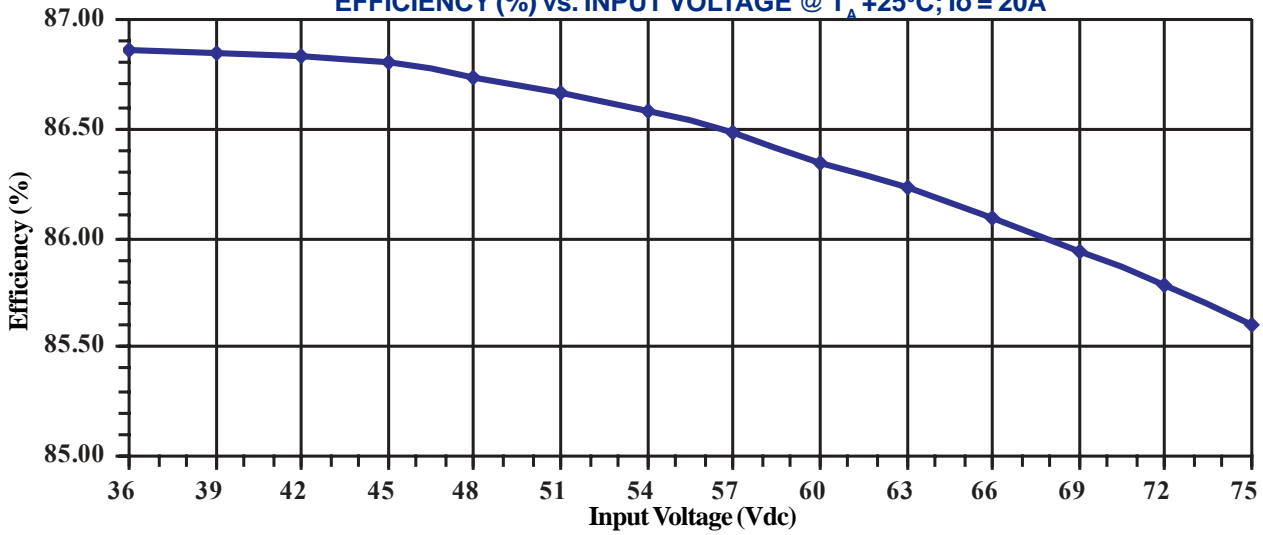

EFFICIENCY (%) vs. AMBIENT TEMP. ($^{\circ}\text{C}$) @ $V_{in} = 48\text{Vdc}$; $I_o = 20\text{A}$

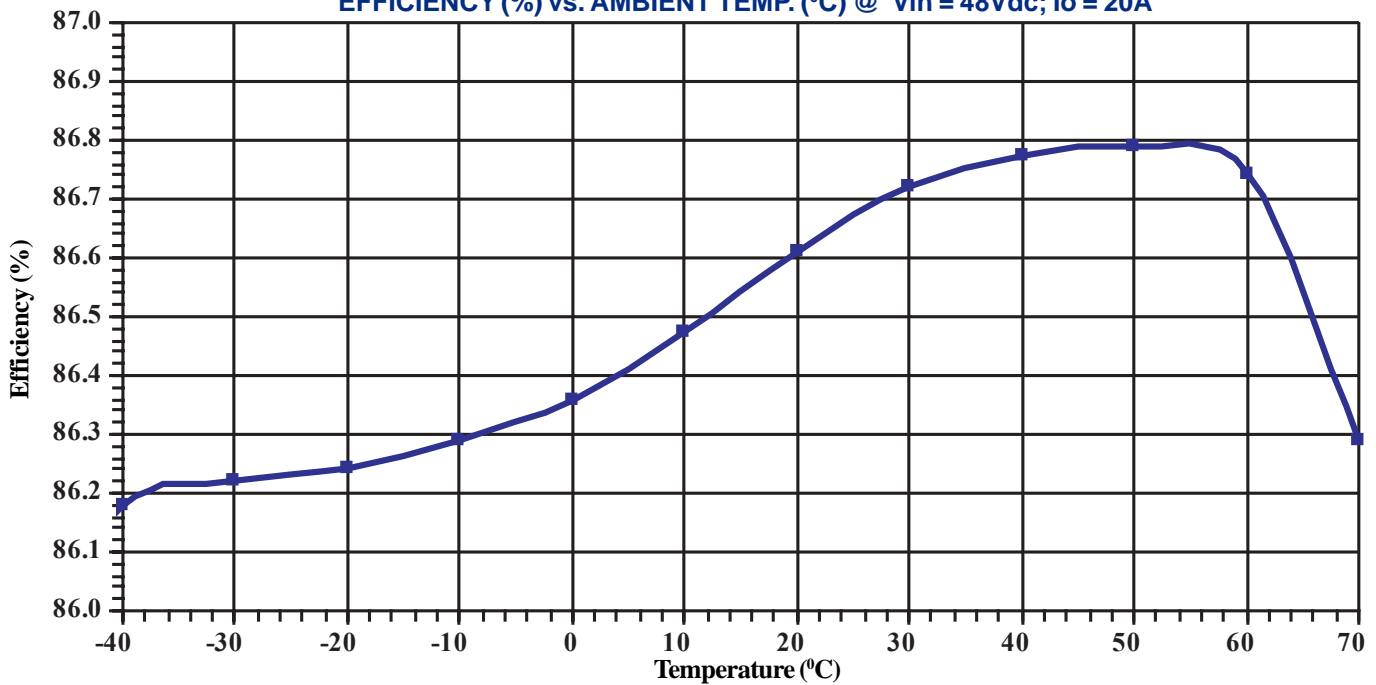

TYPICAL PERFORMANCE CURVES

OUTPUT RIPPLE & NOISE (mV pk-pk) vs. OUTPUT LOAD (A) @ 20MHz; T_A +25°C; Vin = 48Vdc

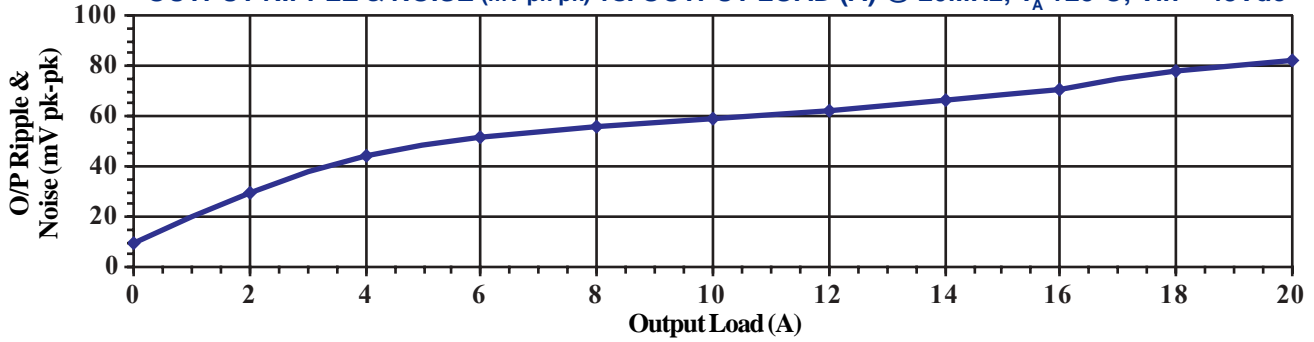

OUTPUT RIPPLE & NOISE (mV pk-pk) vs. INPUT VOLTAGE (Vdc) @ 20MHz; T_A +25°C; Io = 20A

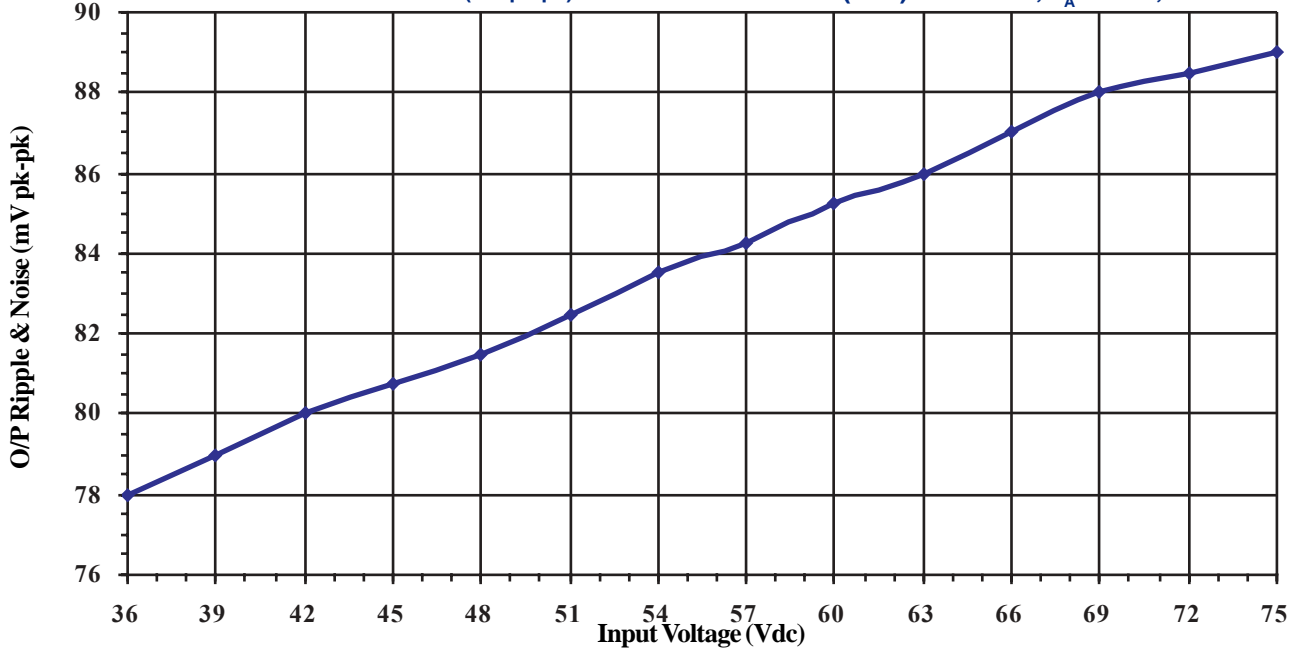

OUTPUT RIPPLE & NOISE (mV pk-pk) vs. AMBIENT TEMP. (°C) @ 20MHz; Vin = 48Vdc; Io = 20A

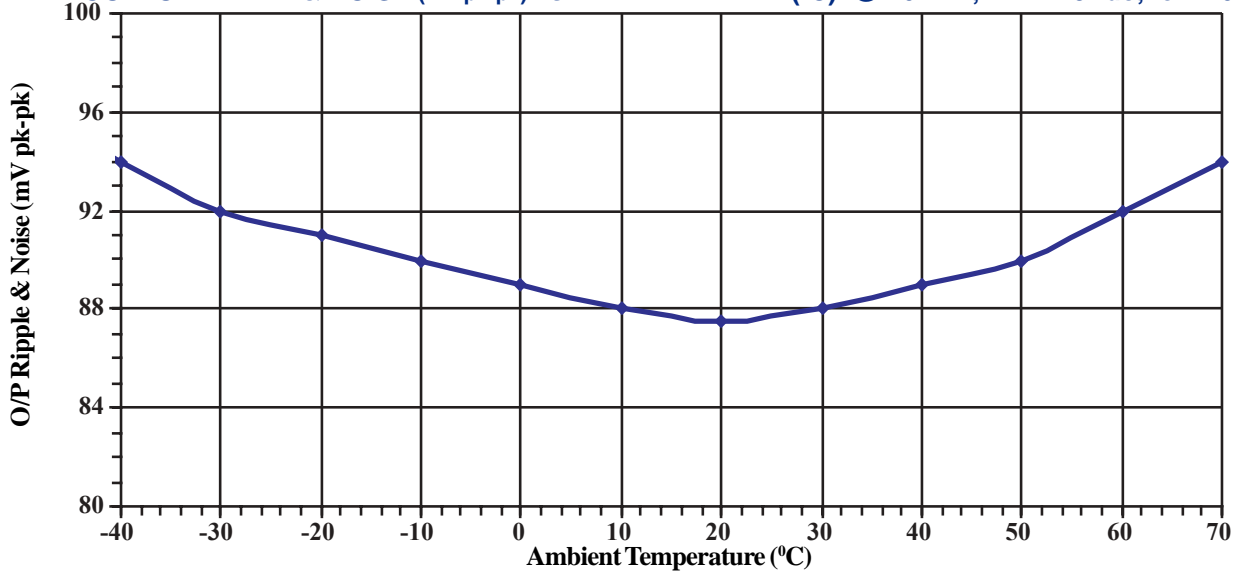

Power Electronics Division, Americas
 3400 E Britannia Drive, Tucson, Arizona 85706
 Tel: 800.547.2537 Fax: 520.295.4197

C&D Technologies, EMEA/Asia/Pacific
 Milton Keynes MK14 5BU UK
 Tel: +44 (0)1908 615232 Fax: +44 (0)1908 617545

Any data, prices, descriptions or specifications presented herein are subject to revision by C&D Technologies, Inc. without notice. While such information is believed to be accurate as indicated herein, C&D Technologies, Inc. makes no warranty and hereby disclaims all warranties, express or implied, with regard to the accuracy or completeness of such information. Further, because the product(s) featured herein may be used under conditions beyond its control, C&D Technologies, Inc. hereby disclaims all warranties, either express or implied, concerning the fitness or suitability of such product(s) for any particular use or in any specific application or arising from any course of dealing or usage of trade. The user is solely responsible for determining the suitability of the product(s) featured herein for user's intended purpose and in user's specific application. C&D Technologies, Inc. does not warrant or recommend that any of its products be used in any life support or aviation or aerospace applications.