

APPLICATIONS

- ✓ RS-232 and RS-423 Data Lines
- ✓ T1/E1 & T3/E3
- ✓ ATM Circuit Interfaces
- ✓ ADSL/HDSL & ISDN Interfaces
- ✓ V.34/V.90
- ✓ Cable Modem Intra-Structure Protection

IEC COMPATIBILITY (EN61000-4)

- ✓ 61000-4-2 (ESD): Air - 15kV, Contact - 8kV
- ✓ 61000-4-4 (EFT): 40A - 5/50ns
- ✓ 61000-4-5 (Surge): 8/20 μ s - 95A, L4(Line-Gnd) & 48A, L4(Line-Line) & 83A, L2(Power)

FEATURES

- ✓ 600 Watts Peak Pulse Power per Line (tp=10/1000 μ s)
- ✓ 100A (2/10 μ s) per Bellcore GR-1089 (Intra-Building)
- ✓ Isolated VSIP® Technology
- ✓ ESD Protection > 40 kilovolts
- ✓ High Surge Capability
- ✓ Lead Spacing of 0.100"
- ✓ Available in 3 Voltages: 5V, 6.5V & 12V
- ✓ Low Capacitance < 50pF
- ✓ RoHS Compliant in Lead-Free Versions

MECHANICAL CHARACTERISTICS

- ✓ Molded Plastic VSIP® Package
- ✓ Weight 1.5 grams (Approximate)
- ✓ Available in Tin-Lead or Lead-Free Pure-Tin Plating(Annealed)
- ✓ Solder Reflow Temperature:
 - Tin-Lead - Sn/Pb, 85/15: 240-245°C
 - Pure-Tin - Sn, 100: 260-270°C
- ✓ Flammability Rating UL 94V-0
- ✓ Marking: Logo, Part Number, Date Code & Pin One Defined By Dot on Top of Package

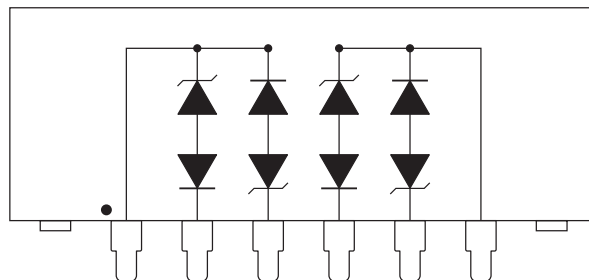
6 PIN VSIP
PIN CONFIGURATION

VSB06P05LCI thru VSB06P12LCI

DEVICE CHARACTERISTICS

MAXIMUM RATINGS @ 25°C Unless Otherwise Specified

PARAMETER	SYMBOL	VALUE	UNITS
Peak Pulse Power ($t_p = 10/1000\mu s$) - See Figure 1	P_{PP}	600	Watts
Operating Temperature	T_J	-55°C to 150°C	°C
Storage Temperature	T_{STG}	-55°C to 150°C	°C

ELECTRICAL CHARACTERISTICS PER LINE @ 25°C Unless Otherwise Specified

PART NUMBER (See Note 1)	DEVICE MARKING	RATED STAND-OFF VOLTAGE V_{WM} VOLTS	MINIMUM BREAKDOWN VOLTAGE @ 1mA $V_{(BR)}$ VOLTS	MAXIMUM CLAMPING VOLTAGE (See Fig. 2) @ $I_P = 10A$ V_C VOLTS	MAXIMUM CLAMPING VOLTAGE (See Fig. 2) @ 10/1000 μs $V_C @ I_{FP}$	MAXIMUM LEAKAGE CURRENT @ V_{WM} I_b μA	MAXIMUM CAPACITANCE 0V @ 1 MHz C_j pF
VSB06P05LCI	VSB06P05LCI	5	6.0	12.5	16.5V @ 36.0A	300	50
VSB06P6.5LCI	VSB06P6.5LCI	6.5	7.2	11.6	15.6V @ 38.0A	300	50
VSB06P12LCI	VSB06P12LCI	12	13.3	18.8	22.8V @ 26.0A	2	50

Note 1: Do not surge from pins 2 to 1, 1 to 3 or 4 to 6, 6 to 5. PIV typically greater than 100 volts for each rectifier diode. For circuit applications external pins 2 & 3 and 4 & 5 are connected.

GRAPHS

**FIGURE 1
PEAK PULSE POWER VS PULSE TIME**

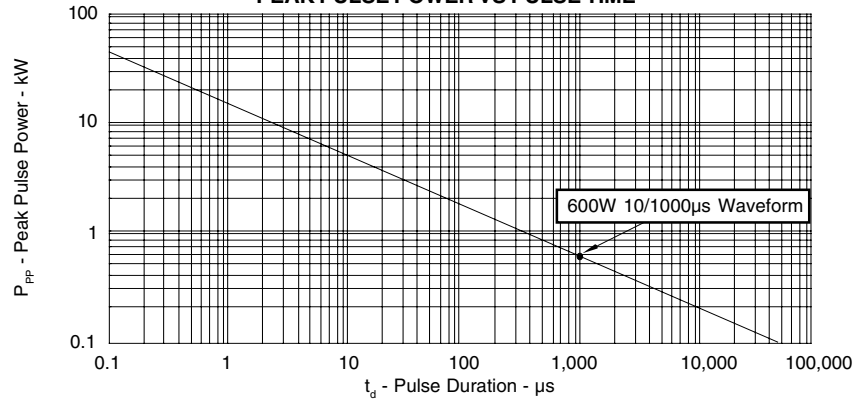

**FIGURE 2
PULSE WAVE FORM**

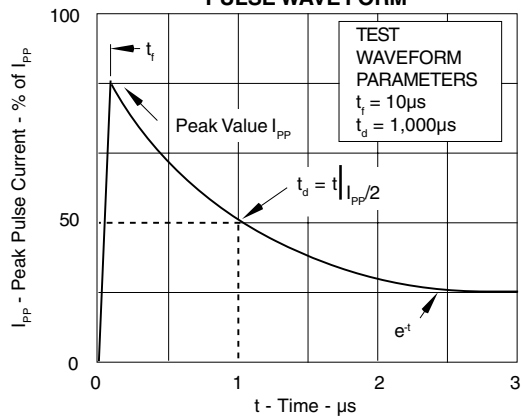

**FIGURE 3
POWER DERATING CURVE**

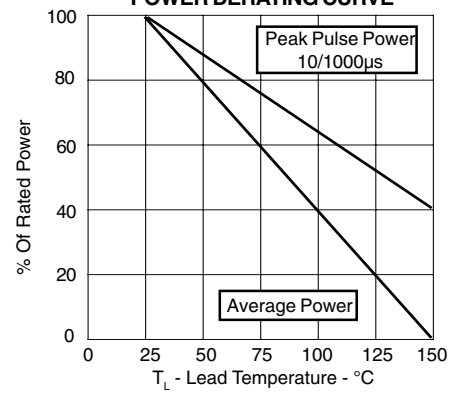

VSB06P05LCI thru VSB06P12LCI

6 PIN VSIP PACKAGE OUTLINE & DIMENSIONS

PACKAGE OUTLINE

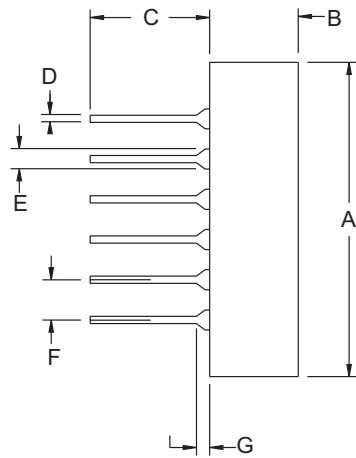
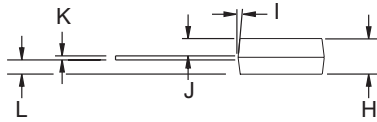

6 PIN VSIP PACKAGE

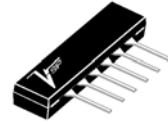

VSIP DIMENSIONS

DIM	MILLIMETERS		INCHES	
	MIN	MAX	MIN	MAX
A	25.81	26.01	1.016	1.024
B	6.25	6.45	0.246	0.254
C	5.92	6.02	0.233	0.237
D	0.406	0.508	0.016	0.020
E	1.47	1.57	0.058	0.062
F	2.49	2.59	0.098	0.102
G	0.38	1.02	0.015	0.040
H	3.20	3.40	0.126	0.134
I	7° TYP	7° TYP	7° TYP	7° TYP
J	1.47	1.57	0.058	0.062
K	0.20	0.30	0.008	0.012
L	1.47	1.57	0.058	0.062

NOTES

1. Dimensions are exclusive of mold flash and metal burrs.

BULK ORDERING NOMENCLATURE

1. Product Shipped in Tubes of 18 pcs per Tube.
2. Suffix -LF = Lead-Free, Pure-Tin Plating, i.e., VSB06P05LCI-LF.

Outline & Dimensions: Rev 1 - 11/01, 06016

COPYRIGHT © ProTek Devices 2006

SPECIFICATIONS: ProTek reserves the right to change the electrical and or mechanical characteristics described herein without notice (except JEDEC).

DESIGN CHANGES: ProTek reserves the right to discontinue product lines without notice, and that the final judgement concerning selection and specifications is the buyer's and that in furnishing engineering and technical assistance, ProTek assumes no responsibility with respect to the selection or specifications of such products.

ProTek Devices

2929 South Fair Lane, Tempe, AZ 85282

Tel: 602-431-8101 Fax: 602-431-2288

E-Mail: sales@protekdevices.com

Web Site: www.protekdevices.com