

# Three Phase Half Controlled Rectifier Bridge, B6HK

$$I_{dAVM} = 110/167 \text{ A}$$

$$V_{RRM} = 1200-1600 \text{ V}$$

| $V_{RSM}$<br>$V_{DSM}$<br>V | $V_{RRM}$<br>$V_{DRM}$<br>V | Type          |               |
|-----------------------------|-----------------------------|---------------|---------------|
| 1300                        | 1200                        | VVZ 110-12io7 | VVZ 175-12io7 |
| 1500                        | 1400                        | VVZ 110-14io7 | VVZ 175-14io7 |
| 1700                        | 1600                        |               | VVZ 175-16io7 |

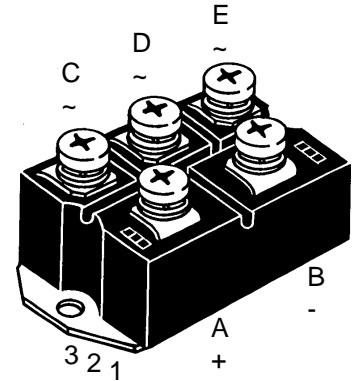
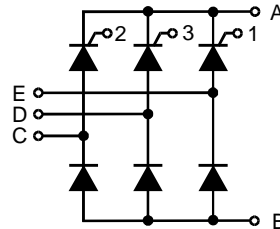

| Symbol                            | Test Conditions  | Maximum Ratings  |                                   |  |
|-----------------------------------|--|--|-----------------------------------|--|
|                                   |  | VVZ 110  | VVZ 175                           |  |
| $I_{dAV}$<br>$I_{FRMS}, I_{TRMS}$ | $T_C = 85^\circ\text{C}$ ; module per leg  | 110<br>58  | 167<br>89                         | A<br>A   |
| $I_{FSM}, I_{TSM}$                | $T_{VJ} = 45^\circ\text{C}$ ; $V_R = 0$<br>$t = 10 \text{ ms (50 Hz), sine}$<br>$t = 8.3 \text{ ms (60 Hz), sine}$   | 1150<br>1230   | 1500<br>1600                      | A<br>A   |
|                                   | $T_{VJ} = T_{VJM}$ ; $V_R = 0$<br>$t = 10 \text{ ms (50 Hz), sine}$<br>$t = 8.3 \text{ ms (60 Hz), sine}$  | 1000<br>1070   | 1350<br>1450                      | A<br>A   |
| $I^2t$                            | $T_{VJ} = 45^\circ\text{C}$ ; $V_R = 0$<br>$t = 10 \text{ ms (50 Hz), sine}$<br>$t = 8.3 \text{ ms (60 Hz), sine}$   | 6600<br>6280   | 11200<br>10750                    | $\text{A}^2\text{s}$<br>$\text{A}^2\text{s}$     |
|                                   | $T_{VJ} = T_{VJM}$ ; $V_R = 0$<br>$t = 10 \text{ ms (50 Hz), sine}$<br>$t = 8.3 \text{ ms (60 Hz), sine}$  | 5000<br>4750   | 9100<br>8830                      | $\text{A}^2\text{s}$<br>$\text{A}^2\text{s}$     |
| $(di/dt)_{cr}$                    | $T_{VJ} = T_{VJM}$ repetitive, $I_T = 50 \text{ A}$<br>$f = 400 \text{ Hz}$ , $t_p = 200 \mu\text{s}$<br>$V_D = 2/3 V_{DRM}$<br>$I_G = 0.3 \text{ A}$ , non repetitive,<br>$di_G/dt = 0.3 \text{ A}/\mu\text{s}$ , $I_T = 1/3 \cdot I_{dAV}$ |  | 150<br>500                        | $\text{A}/\mu\text{s}$<br>$\text{A}/\mu\text{s}$ |
| $(dv/dt)_{cr}$                    | $T_{VJ} = T_{VJM}$ ; $V_{DR} = 2/3 V_{DRM}$<br>$R_{GK} = \infty$ ; method 1 (linear voltage rise)  |  | 1000                              | $\text{V}/\mu\text{s}$                           |
| $V_{RGM}$                         |  |  | 10                                | V  |
| $P_{GM}$                          | $T_{VJ} = T_{VJM}$<br>$I_T = I_{TAVM}$   | $t_p = 30 \mu\text{s}$<br>$t_p = 500 \mu\text{s}$<br>$t_p = 10 \text{ ms}$ | $\leq 10$<br>$\leq 5$<br>$\leq 1$ | W<br>W<br>W                                      |
| $P_{GAVM}$                        |  |  | 0.5                               | W  |
| $T_{VJ}$                          |  |  | -40...+125                        | $^\circ\text{C}$                                 |
| $T_{VJM}$                         |  |  | 125                               | $^\circ\text{C}$                                 |
| $T_{stg}$                         |  |  | -40...+125                        | $^\circ\text{C}$                                 |
| $V_{ISOL}$                        | 50/60 Hz, RMS $t = 1 \text{ min}$<br>$I_{ISOL} \leq 1 \text{ mA}$ $t = 1 \text{ s}$  |  | 2500<br>3000                      | V~<br>V~   |
| $M_d$                             | Mounting torque (M6)<br>Terminal connection torque (M6)  |  | 5±15 %<br>5±15 %                  | Nm<br>Nm   |
| Weight                            | typ.   |  | 300                               | g  |

## Features

- Package with screw terminals
- Isolation voltage 3000 V~
- Planar passivated chips
- UL registered E72873

## Applications

- Input rectifier for PWM converter
- Input rectifier for switch mode power supplies (SMPS)
- Softstart capacitor charging

## Advantages

- Easy to mount with two screws
- Space and weight savings
- Improved temperature and power cycling

Data according to IEC 60747 and refer to a single thyristor/diode unless otherwise stated.  
IXYS reserves the right to change limits, test conditions and dimensions.

| Symbol     | Test Conditions   | Characteristic Values        |            |                  |
|------------|---|------------------------------|------------|------------------|
|            |   | VVZ 110                      | VVZ 175    |                  |
| $I_R, I_D$ | $V_R = V_{RRM}; V_D = V_{DRM}$  | $T_{VJ} = T_{VJM}$           | $\leq 5$   | mA               |
|            |   | $T_{VJ} = 25^\circ\text{C}$  | $\leq 0.3$ | mA               |
| $V_F, V_T$ | $I_F, I_T = 200 \text{ A}, T_{VJ} = 25^\circ\text{C}$   | $\leq 1.75$                  | 1.57       | V                |
| $V_{T0}$   | For power-loss calculations only  | 0.85                         | 0.85       | V                |
| $r_T$      | ( $T_{VJ} = 125^\circ\text{C}$ )  | 6                            | 3.5        | m $\Omega$       |
| $V_{GT}$   | $V_D = 6 \text{ V};$  | $T_{VJ} = 25^\circ\text{C}$  | $\leq 1.5$ | V                |
|            |   | $T_{VJ} = -40^\circ\text{C}$ | $\leq 1.6$ | V                |
| $I_{GT}$   | $V_D = 6 \text{ V};$  | $T_{VJ} = 25^\circ\text{C}$  | $\leq 100$ | mA               |
|            |   | $T_{VJ} = -40^\circ\text{C}$ | $\leq 200$ | mA               |
| $V_{GD}$   | $T_{VJ} = T_{VJM}; V_D = 2/3 V_{DRM}$   | $\leq 0.2$                   | 0.2        | V                |
| $I_{GD}$   | $T_{VJ} = T_{VJM}; V_D = 2/3 V_{DRM}$   | $\leq 5$                     | 5          | mA               |
| $I_L$      | $I_G = 0.3 \text{ A}; t_G = 30 \mu\text{s}; di_G/dt = 0.3 \text{ A}/\mu\text{s}; T_{VJ} = 25^\circ\text{C}$ | $\leq 450$                   | 450        | mA               |
| $I_H$      | $T_{VJ} = 25^\circ\text{C}; V_D = 6 \text{ V}; R_{GK} = \infty$   | $\leq 200$                   | 200        | mA               |
| $t_{gd}$   | $T_{VJ} = 25^\circ\text{C}; V_D = 1/2 V_{DRM}; I_G = 0.3 \text{ A}; di_G/dt = 0.3 \text{ A}/\mu\text{s}$    | $\leq 2$                     | 2          | $\mu\text{s}$    |
| $R_{thJC}$ | per thyristor (diode); DC current per module  | 0.65                         | 0.46       | K/W              |
|            |   | 0.108                        | 0.077      | K/W              |
| $R_{thJH}$ | per thyristor (diode); DC current per module  | 0.8                          | 0.55       | K/W              |
|            |   | 0.133                        | 0.092      | K/W              |
| $d_s$      | Creeping distance on surface  | 10                           | 10         | mm               |
| $d_A$      | Creepage distance in air  | 9.4                          | 9.4        | mm               |
| $a$        | Max. allowable acceleration   | 50                           | 50         | m/s <sup>2</sup> |

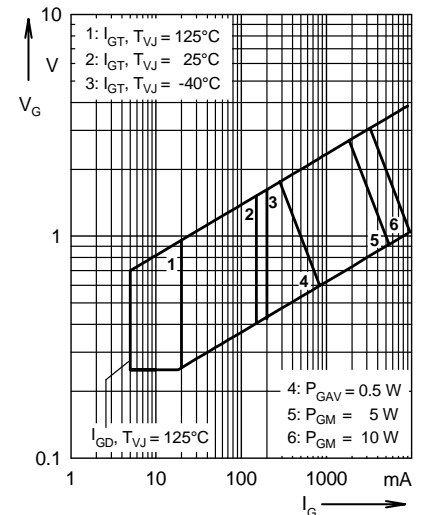

Fig. 1 Gate trigger characteristics

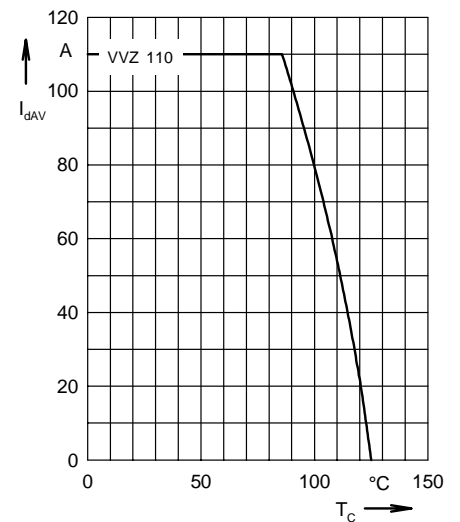

Fig. 2 DC output current at case temperature

Dimensions in mm (1 mm = 0.0394")

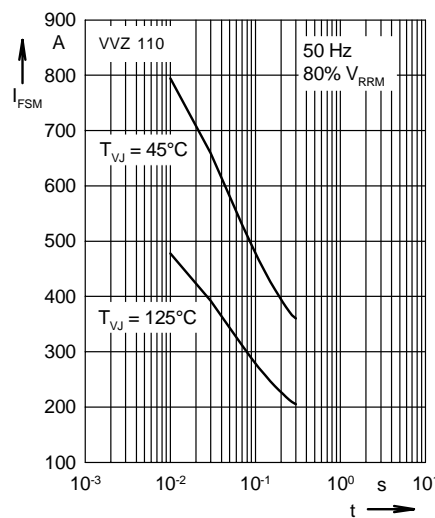
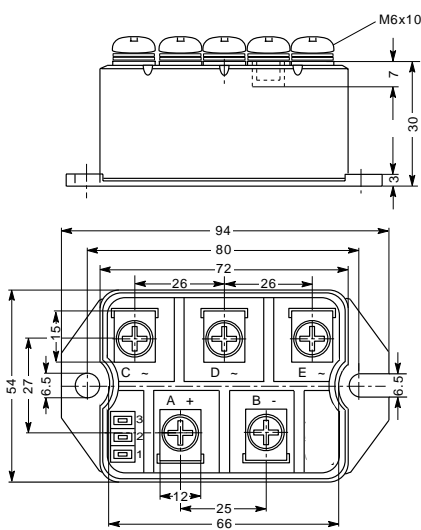

Fig. 3 Surge overload current  
 $I_{FSM}$ : Crest value, t: duration

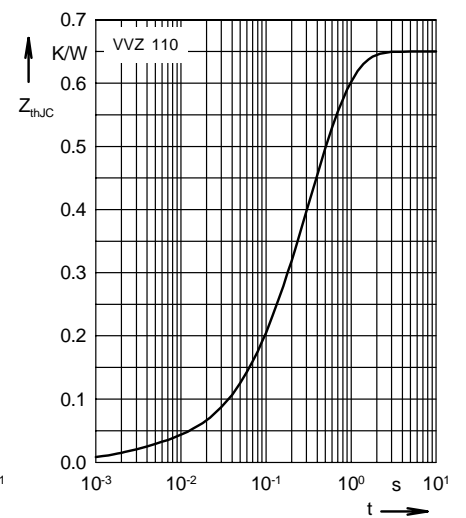

Fig. 4 Transient thermal impedance junction to case (per leg)